

# TOSHIBA

**CDL**  
Cool Designs Ltd



# VRF PRODUCT SPECIFICATION



ENERGY EFFICIENT



CARBON NEUTRAL



INNOVATIVE



CUSTOMER CENTRIC

## > COMMITMENT TO BETTER AIR SOLUTIONS



Toshiba Air Conditioning supports Carrier's 2030 Environmental, Social, and Governance (ESG) goals, including the goal to reduce its customers' carbon footprint by more than 1 gigaton. We help to address climate change by going further than just products and beyond their basic functions, to create reliable and safe solutions that can interact with each other and with users. With the forward-thinking solutions by Toshiba Air Conditioning, we help deliver healthy, safe and productive indoor environments.

## > CHOOSE THE EXPERT OF INSPIRED TECHNOLOGIES

Since Toshiba Air Conditioning developed and mass-produced the world's-first inverter split air conditioners for commercial and residential applications in 1980 and 1981, which is a historically significant milestone recognized by the Institute of Electrical and Electronics Engineers (IEEE), inverter technology has been widely used throughout the world to deliver comfort with high energy efficiency.

Inverter technology enables the unit to continuously regulate its cooling and heating capacity by altering the speed of the compressor using a variable-frequency drive to control the speed of the motor. This innovation helps generate outstanding comfort and efficiency levels.

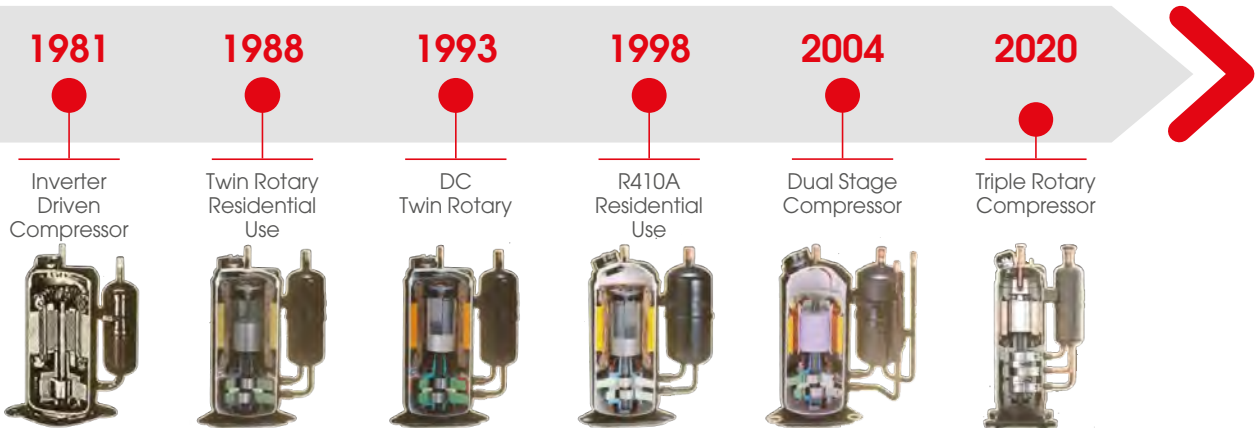

Our commitment to world-class **efficiency**, versatile **scalability** and leading **quality** means we create cutting-edge technologies to find the most forward-thinking solutions possible for your world. Toshiba Air Conditioning is an innovative provider of comprehensive air conditioning solutions with world-class reliability.

### > Top-class energy efficiency

- High volume triple rotary compressor
- Twin rotary compressors
- All climates from -30°C (DAISEIKAI™ 9) to 54°C (MiNi SMMS-e Middle East range)
- Top class A+++ air to water heating solutions with ESTIA™ R32
- Refrigerants with lower environmental impact
- Optimal temperature control solutions with precision

### > Scalable solutions

Toshiba Air Conditioning develops cutting-edge technologies that benefit people by offering the ideal combination of comfort and products that help to protect the environment for residential, light commercial and large building applications.

### > Superior manufacturing quality

Toshiba Air Conditioning's innovations provide comprehensive building air conditioning solutions which have been subject to strict evaluation testing to offer world-class reliability.

Third party institute certifications for quality, safety and performance, guaranteed (TÜV, Eurovent, WEEE, RoHS, REACH, Intertek, Keymark).



## > TAILORED TO MEET CHALLENGES

Toshiba Air Conditioning, with heat pump technology at its core, contributes to people's well-being while respecting the environment. For decades, Toshiba Air Conditioning has been receiving prestigious awards for its significant achievements in air conditioning. This demonstrates the innovative spirit of Toshiba Air Conditioning, a relentless drive to improve its products and systems.

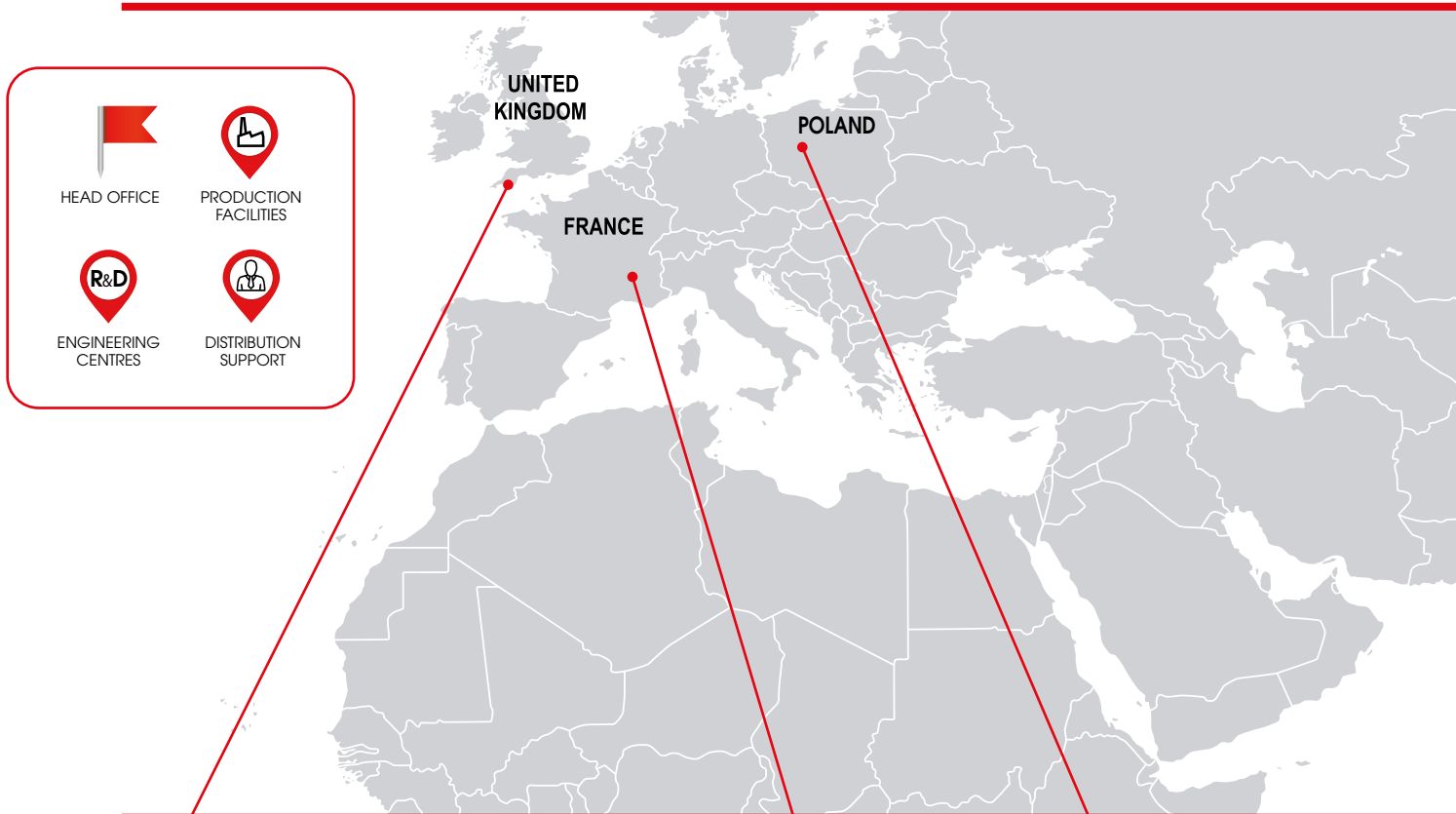

▶ PLYMOUTH, UNITED KINGDOM



TCEU - DISTRIBUTION SUPPORT  
and  
TCEU - ENGINEERING CENTRE

▶ MONTLUEL, FRANCE



TCEU - ENGINEERING CENTRE  
and  
TOSHIBA EMEA

▶ GNIEZNO, POLAND



TCAE - PRODUCTION FACILITIES  
and  
TCAE - ENGINEERING CENTRE



HARYANA, INDIA



TCAI - PRODUCTION FACILITIES



PATHUMTHANI, THAILAND



TCTC - ENGINEERING CENTRE  
and  
TCTC - PRODUCTION FACILITIES



HANGZHOU, CHINA



TCAC - PRODUCTION FACILITIES

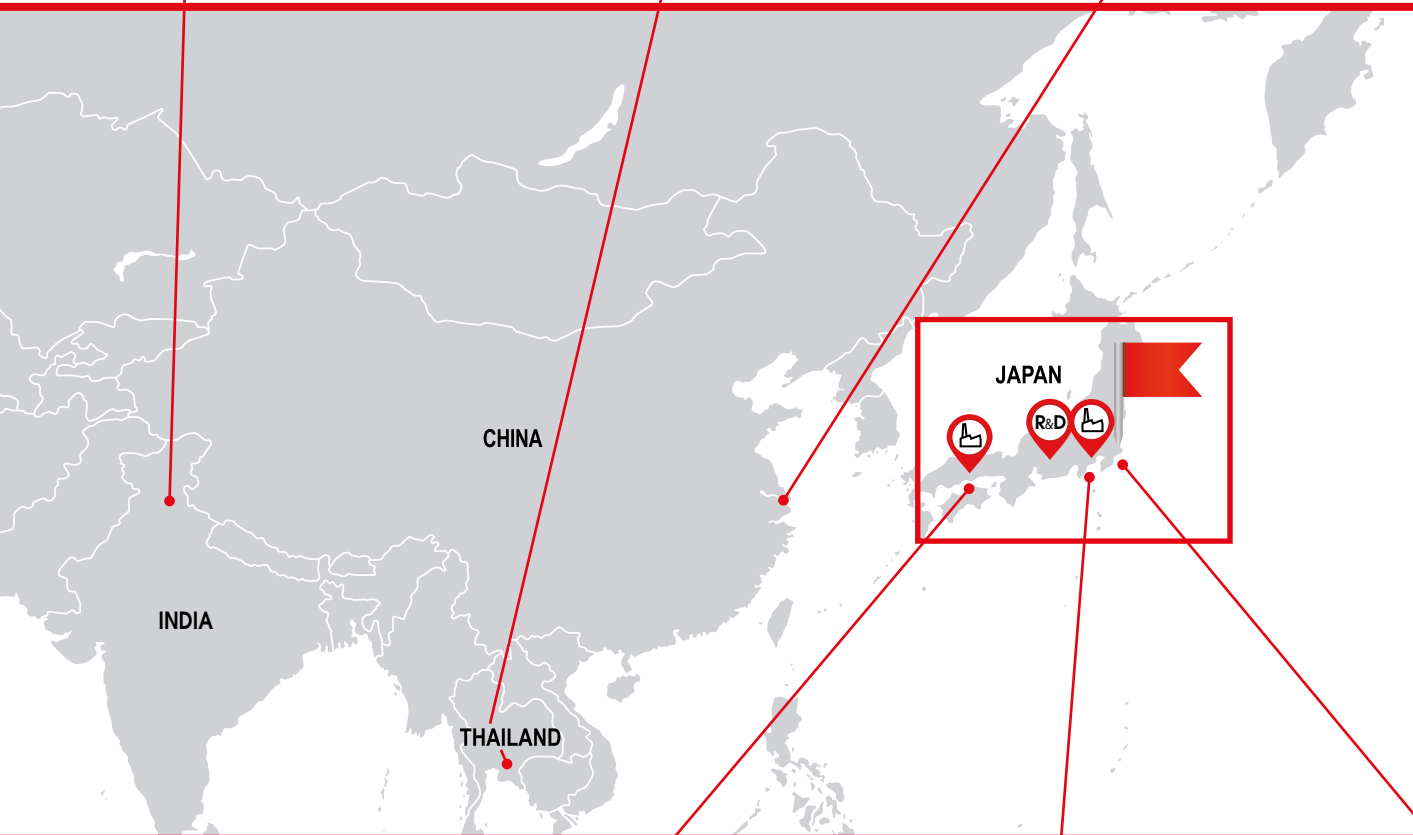

TSUYAMA-CITY, JAPAN



TCC - PRODUCTION FACILITIES



FUJI-CITY, JAPAN



TCC - PRODUCTION FACILITIES  
and  
TCC - ENGINEERING CENTRE



KAWASAKI-CITY, JAPAN



TCC - HEAD OFFICE

# > LEADING THE WAY TO EXCELLENCE

## > Products designed and engineered to perform

Toshiba Air Conditioning strengths center on in-house research and development of advanced technologies and core components. Its global research activities are managed and integrated to ensure all research sites collaborate to provide innovative solutions to customers across the world.

## > Forward-thinking technologies to support building decarbonisation

Toshiba Air Conditioning combines technological development with consideration for future generations, resulting in a range of extremely energy-efficient air conditioners, helping to reduce greenhouse gas emissions at their source. Its continuous research into the development of inverter technology has provided remarkable results, both with regards to meeting the required comfort levels and continually reducing the system's energy consumption.



Quality production



Outdoor units production



Indoor units production

## > Entire production process certified by international quality assurance institutes

All products provide high operating efficiency and cooling, as they participate in the Eurovent programme. This acts as a guarantee for customers and users that the products will operate in accordance with the design specifications and that the data published is grounded by evidence.

Toshiba Air Conditioning participates in the Eurovent Certification Performance programme for AC1, AC2 & VRF.

Check ongoing validity of certificate: [www.eurovent-certificate.com](http://www.eurovent-certificate.com)

For Estia certification, refer to Keymark heat pump certification program: [www.heatpumpkeymark.com](http://www.heatpumpkeymark.com)



011-1W0341 → 0348

### > In line with European standards

To improve its environmental responsibility, Toshiba Air Conditioning offers products that meet the following European standards:

#### EN 14511

Air conditioners, liquid chilling packages and heat pumps with electrically driven compressors for space heating and cooling. Test methods.

#### EN 14825

Air conditioners, liquid chilling packages and heat pumps, with electrically driven compressors, for space heating and cooling. Testing and rating with part loads and calculation of seasonal performance.

#### EN 16147

Heat pumps with electrically driven compressors. Testing, performance rating and requirements for marking domestic hot water units.



Japan - Fuji Operations R&D Centre e-THIRD building

# > THE WORLD IS TARGETING ZERO EMISSIONS

Today the process of cooling and heating buildings is not the sole challenge. Global warming is an issue that affects all of us and Toshiba Air Conditioning is prioritizing the decarbonisation of buildings as a top priority.

The R32 based solutions proposed by Toshiba Air Conditioning help achieve this goal, whilst also preserving comfort and cost-effectiveness.

## > A range in line with our goal to reduce our customers' carbon footprint

Toshiba Air Conditioning is offering a complete range of air-to-air products dedicated to cooling and heating in comfort applications. With system solutions from 2 to 67kW, we can address residential, light commercial and business markets requirements.

### Residential

HAORI™ is a truly elegant air conditioner, featuring a stylish textile fabric cover that uses Toshiba inverter and compressor technology with R32 refrigerant, offering A+++ performance and year-round comfort.

### Light commercial

A full range of Toshiba R32 light commercial systems is available on the European market including a Super Digital Inverter™ with an excellent efficiency.

### Business

After the switch to low GWP refrigerant for its residential and light commercial products, Toshiba Air Conditioning is now one of the first to launch VRF using R32 refrigerant: The SHRM Advance™ and MiNi-SMMS™ give a new environmental dimension to your projects.







## > The right choice...

The fundamental design and control of Toshiba Air Conditioning systems remains unchanged with the R32 refrigerant. Toshiba Air Conditioning unique combination of twin rotary compressors and all inverter driven control also contributes to guaranteed accuracy and expertise of flawless Japanese quality. All these result in the high level of performance and efficiency our customers are used to.

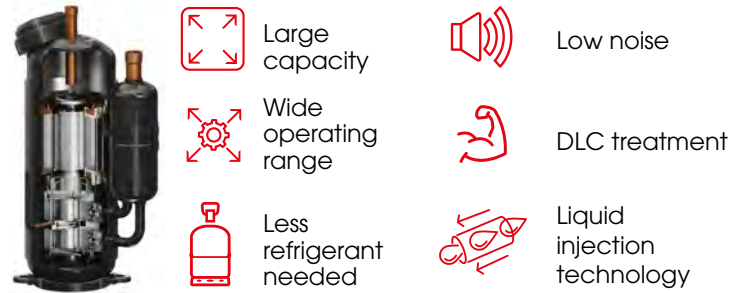

Toshiba Twin rotary compressor with new liquid injection technology, your best ally. Centre piece of the system, the Toshiba super-efficient twin rotary compressor has been engineered to match R32 refrigerant requirements.

## > ...to the benefit of all

### Design to help protect the environment

- The right balance between environment safety and your comfort
- Energy efficiency increased for greater savings

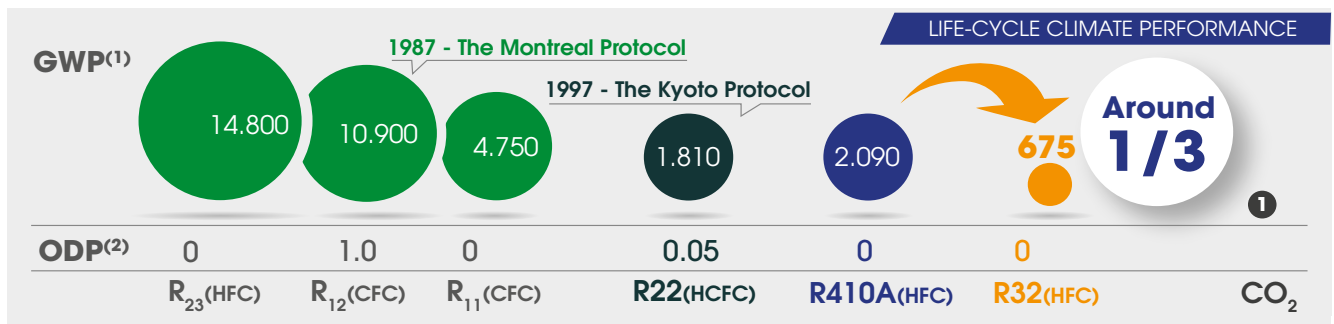

<sup>(1)</sup> Global Warming Potential  
<sup>(2)</sup> Ozone Depletion Potential

### Installer friendly

- Working pressures for R410A and R32 refrigerants are similar
- R32 refrigerant can be easily charged in both liquid or gas state
- Safety commissioning instructions are similar to those for R410A
- R32 and R410A equipments is the same except for the refrigerant recovery pump and the reclaim cylinder
- Toshiba flare joints certified ISO14903

Low GWP with R32 refrigerant and 40% less refrigerant charge in SHRM Advance have led to an 80% reduction in the total CO<sub>2</sub> equivalent of the system, in comparison with legacy model using R410A refrigerant.

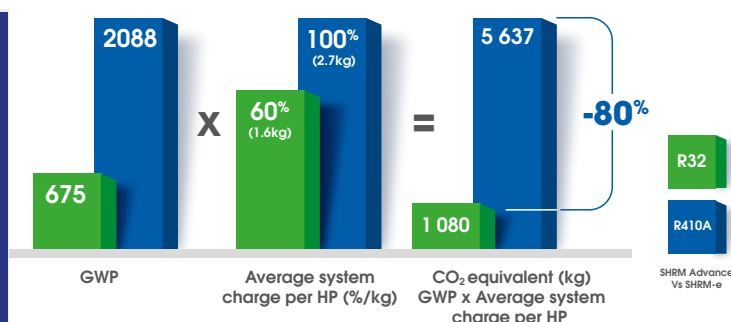

## > F-GAS COMPLIANCE

### > TOSHIBA AIR CONDITIONING RESPONDS TO REGULATORY EVOLUTIONS

The European F-gas regulation (517/2014) has been in force since 1 January 2015. It aims to protect the environment by reducing greenhouse gas emissions and progressively deploying new rules related to the use of Hydrofluorocarbons refrigerants (HFCs) in heating and cooling systems. This regulation introduces an ambitious gradual reduction of HFC quantities that are put on the market in the EU by HFC producers and distributors (in equivalent tons of CO<sub>2</sub>), with an initial reduction of 37% from 2018 and a final objective of cutting quantities by 79% by 2030.

This regulation has driven manufacturers to turn to refrigerants with lower Global Warming Potential (GWP) and Toshiba air conditioning is no exception; efforts have been made to pursue lower GWP refrigerant while the reduction of refrigerant charge volume has been explored.



\*HFC consumption compared to equivalent tons of CO<sub>2</sub>

### > Your safety first and foremost

Based on the requirements of the F-gas regulation, only certified installers can carry on Dx system installations. The implementation of systems using HFC requires thus some specific precautions such as a strict control of the leakages and a periodic checking of the refrigerant charge.

For equipment containing			Leak checks without leak detection	Leak checks with leak detection
Between 5 and 50 tonnes CO <sub>2</sub> equivalent	2.38 and 23.8kg R410A	7.41 and 74.1kg R32	Every 12 months	Every 24 months
Between 50 and 500 tonnes CO <sub>2</sub> equivalent	23.8 and 238kg R32	74.1 and 740kg R32	Every 6 months	Every 12 months
More than 500 tonnes CO <sub>2</sub> equivalent	More than 238kg R410A	More than 740kg R32	Every 3 months	Every 6 months

## ECODESIGN & ENERGY LABELLING

The European 2030 climate and energy framework for improving energy efficiency will have a significant impact on the heating, ventilation and air conditioning sectors.

Today, buildings are responsible for the largest energy consumption, with HVAC systems being the most energy-intensive of all. The HVAC sector is now committed to manufacturing energy-efficient products for its clients to favour sustainable development.

### Ecodesign and Energy Labelling for Air-to-Water heat pumps

Air-to-Water heat pumps have been subject by the Ecodesign (< 400kW) and Energy Labelling (< 70kW) regulations since 26 September 2015. Heat pumps launched before this date are not concerned and all must conform to display the CE mark.

For more information visit [www.ecodesign.toshiba-airconditioning.eu](http://www.ecodesign.toshiba-airconditioning.eu)

### New energy efficiency metric: Seasonal efficiency (SEER and SCOP)

The Seasonal Coefficient of Performance is a new European parameter to rate heat pumps in terms of energy efficiency. It is an update to the Coefficient of Performance, which previously recorded the power consumed to power produced ration in heating and cooling modes for one operating point.

Unlike the EER/COP, the SEER/SCOP takes into account performances during cooler seasons because it indicates temperature variations by including numerous realistic measurement points. When combined, this results in a more accurate energy classification.

#### SEER/SCOP compared to EER/COP

TEMPERATURE		CAPACITY (KW)		AUX		HOURS	
<b>EER</b> <b>COP</b>	<b>SEER</b> <b>SCOP</b>	<b>EER</b> <b>COP</b>	<b>SEER</b> <b>SCOP</b>	<b>EER</b> <b>COP</b>	<b>SEER</b> <b>SCOP</b>	<b>EER</b> <b>COP</b>	<b>SEER</b> <b>SCOP</b>
One temperature requirement	Numerous rating temperatures (range of average temperatures)	Full load	Partial load + Full load	Auxiliary power modes are not considered	Incl. consumption auxiliary modes: - Standby mode - Off mode - Thermostat off, etc.	N/A	Number of hours at each air temperature (in hours)

**SEASONAL COEFFICIENT OF PERFORMANCE CALCULATION**

This is the ratio between annual heating/cooling demand and annual energy input over an entire heating/cooling season.

SCOP =



---

ANNUAL ENERGY INPUT  
ANNUAL HEATING DEMAND

SEER =



---

ANNUAL COOLING DEMAND





---

ANNUAL ENERGY INPUT

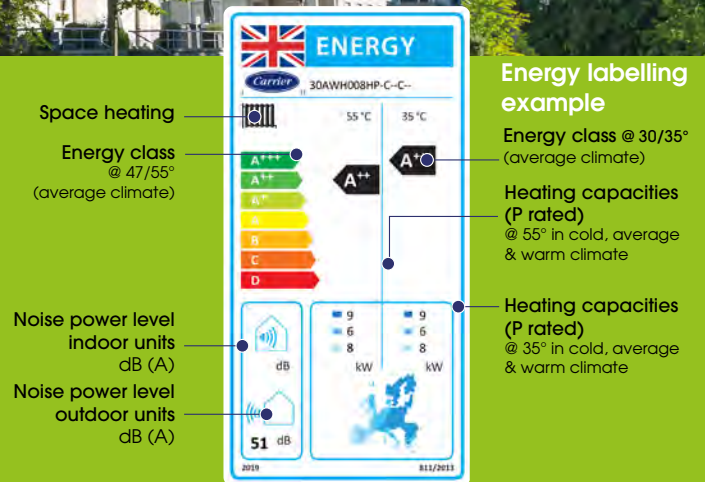

## ENERGY LABELLING

The Energy Labelling regulation was created to offer end users information about a product's energy efficiency rating. European Energy Labelling regulations also assign ratings from G to A++ based on their energy efficiency, inciting better ratings in the sector and providing clients with clearer information.





## Designed for the future

Toshiba Air Conditioning is committed to designing products and solutions with increasingly lower environmental impacts. This is subsequently reducing indirect CO<sub>2</sub> emissions generated by electricity consumption. Toshiba Air Conditioning long-standing commitment to sustainable development is ahead of schedule for the European climate and energy package requirements for 2030.

All Toshiba Air Conditioning products sold today in Europe are fully compliant with the latest Ecodesign directives.

 Lot 1: Air-to-Water heating systems up to 400kW including air-to-water heat pumps >>> ESTIA™ SPLIT.

 Lot 2: Water heaters and hot water storage tanks. Including tanks >>> ESTIA DHW-HP.

 Lot 6: Residential and non residential ventilation including air treatment VN units.

 Lot 10: Air-to-Air heat pumps up to 12kW >>> SEYIA™, SHORAI™ Edge, HAORI™, DAISEIKAI™ 9, Console, Digital Inverter, Super Digital Inverter.

 Lot 11: Electric motors from 125W to 500kW including ventilation fans.

 Lot 21: Heat pumps above 12kW including residential, light commercial systems and VRF >>> Digital Inverter™, Super Digital Inverter™, Big Digital Inverter™, Mini SMMS-e™, SMMS-e™, SHRM-e™, SMMS-u™ and SHRM Advance™.

Toshiba Air Conditioning dedicated public website provides energy labels with detailed performances for all systems.

For more information visit  
[www.ecodesign.toshiba-airconditioning.eu](http://www.ecodesign.toshiba-airconditioning.eu)

## EXPERIENCE THE FUTURE



### > TO GUIDE YOU



MAX  
EFFICIENCY



INTERACTIVE



CAPACITY



OPERATION  
RANGE



D.H.W



LOW  
SOUND LEVEL



HIGH  
AIR FLOW



TWIN ROTARY  
COMPRESSOR



LIGHT WEIGHT



NFC  
COMPATIBLE



SPIGOT  
COMPATIBLE



EASY  
INSTALLATION



COMPACT



INFRARED  
CONTROLLER



ENHANCED  
FILTRATION



SELF  
CLEANING



ADJUSTABLE  
HEIGHT



ENERGY  
SAVING



AIR  
DISTRIBUTION



FLEXIBLE  
PIPING



REDUCED  
FOOTPRINT



STATIC  
PRESSURE



INDIVIDUAL  
HOUSING



REFURBISHMENT



SHOPS



RETAIL



BUSINESSES



ADMINISTRATION



HOTELS



HEALTHCARE



OFFICES

Contents	Model Reference	Pages
<b>VRF High Wall Indoor Units</b>		<b>15 - 33</b>
Standard High Wall	<a href="#">MMK - UP***1HP-E</a>	15 - 26
Premium High Wall (Haori)	<a href="#">MMK - UP***1HPL-E</a>	27 - 33
<b>VRF Cassette Indoor Units</b>		<b>34 - 88</b>
1-Way Slim Cassette	<a href="#">MMU - UP***1YHP-E</a>	34 - 43
1-Way Standard Cassette	<a href="#">MMU - UP***1SH-E</a>	44 - 47
2-Way Cassette	<a href="#">MMU - UP***1WH-E</a>	48 - 59
4-Way Compact Cassette	<a href="#">MMU - UP***1MH-E</a>	60 - 66
4-Way Standard Cassette	<a href="#">MMU - UP***1HP-E</a>	67 - 77
4-Way Smart Cassette	<a href="#">MMU - UP***1H-E</a>	78 - 88
<b>VRF Ducted Indoor Units</b>		<b>89 - 120</b>
Slim Ducted	<a href="#">MMD - UP***1SPHY-E</a>	89 - 98
Standard Ducted (Horizontal / Vertical)	<a href="#">MMD - UP***1BHP-E</a>	99 - 111
High Static Ducted	<a href="#">MMD - UP***1HP-E</a>	112 - 120
<b>VRF Other Indoor Units</b>		<b>121 - 162</b>
Ceiling Suspended	<a href="#">MMC - UP***1HP-E</a>	121 - 128
Concealed Chassis	<a href="#">MML - UP***1BH-E</a>	129 - 135
Floor Mounted Console	<a href="#">MML - UP***1H-E</a>	136 - 142
Bi Flow Console	<a href="#">MML - UP***1NHP-E</a>	143 - 148
Floor Mounted Cabinet	<a href="#">MMF - UP***1NHP-E</a>	149 - 156
Fresh Air Intake	<a href="#">MMD - UP***1HFP-E</a>	157 - 162
<b>VRF Heat Recovery Ventilation Units</b>		<b>163 - 172</b>
Air-to-Air Heat Exchanger	<a href="#">VN - U***1SY-E</a>	163 - 172
<b>VRF Hot Water Production Units</b>		<b>173 - 176</b>
Mid Temperature Hot Water Module	<a href="#">MMW - UP***1LQ-E</a>	173 - 175
High Temperature Hot Water Module	<a href="#">MMW - AP***1CHQ-E</a>	176
<b>VRF R410a Outdoor Units (Heat Pump &amp; Heat Recovery)</b>		<b>177 - 276</b>
Mini SMMSe - Single Fan	<a href="#">MCY - MHP***6HT-E</a>	177 - 179
Mini SMMSe - Twin Fan	<a href="#">MCY - MHP***4HS-E</a>	180 - 187
SMMSu - 2 Pipe	<a href="#">MMY - MUP***1HT8P-E</a>	188 - 197
SMMSu - Combinations	<a href="#">MMY - UP***1HT8P-E</a>	198 - 245
SHRMe - 3 Pipe	<a href="#">MMY - MAP***6FT8P-UK</a>	246 - 253
SHRMe - Combinations	<a href="#">MMY - AP***6FT8P-UK</a>	254 - 273
SHRMe - Flow Selector Boxes	<a href="#">RBM - Y****E</a>	274 - 276
<b>VRF R32 Outdoor Units (Heat Pump &amp; Heat Recovery)</b>		<b>277 - 280</b>
Mini SMMS - Single Fan	<a href="#">MCY - MUG***1HSW-E</a>	277 - 280
SHRM Advance - 2/3 Pipe	<a href="#">MMY - SUG***1MT8P-E</a>	281 - 290
SHRM Advance - Flow Selectors / Safety Devices	<a href="#">RBM/TCB****E</a>	291 - 294
<b>Controls</b>		<b>295 - 200</b>
<a href="#">Wireless Controllers, Occupancy Sensors &amp; Wired Controllers</a>		296
<a href="#">Wired Central, Control Panel, Control Software &amp; Indoor Interface</a>		297
<a href="#">Indoor Interface (Continued) &amp; Leak Detection</a>		298
<a href="#">Indoor Interface Lead &amp; Interface</a>		299
<a href="#">Outdoor Interface</a>		300
<b>Accessories</b>		<b>301 - 305</b>
<a href="#">Piping Kits: Pulse Modulating Valve Kit, Elbow Kits &amp; Branch Joints</a>		301
<a href="#">Piping Kits: Headers &amp; Y-Joints</a>		302
<a href="#">Miscellaneous: Air Discharge, Filtration &amp; Inlet</a>		303
<a href="#">Miscellaneous: Air Discharge, Filtration &amp; Inlet (Continued), VN Heater Kits &amp; Painted finish</a>		304
<a href="#">Miscellaneous: Fabric Covers (Haori), Anti-Corrosion Coatings, Split Cases/ &amp; Site Services</a>		305
<b>Brochures</b>		<b>306</b>
<a href="#">Brochures</a>		306

# Standard High Wall



## VRF STANDARD HIGH WALL: MMK - UP0031HP-E

- Special fin coating for healthy & fresh air.
- New appearance, simple, elegant with led display.
- Perfect for limited spaces, such as offices or small shops.
- Filters for dust collection can be easily removed and easily cleaned.
- New compact design (only 293x798x230 mm) and lightweight (11 kg).



Hi - Res Image

### Performance Data

Capacity Code		HP	0.3
Nominal	Cooling Capacity	kW	0.9
	Heating Capacity	kW	1.3
UK	Cooling Total/Sensible	kW	0.9/0.7
	Heating	kW	0.9
Electrical	Power Input	kW	0.015
	Run Current	Amps	0.15
	Start Current	Amps	0.19

### Indoor Data

Airflow	High - Medium - Low	l/s	126 - 103 - 75
	High - Medium - Low	m3/h	455 - 370 - 270
Sound	Pressure High - Medium - Low	dB(A)	33 - 29 - 25
	Power High - Medium - Low	dB(A)	48 - 44 - 40
Unit	Height x Width x Depth	mm	293 x 798 x 230
	Weight	kg	11
Pipe Connection	Flare Connections (gas - liquid)	inch	3/8 - 1/4
	Drain Pipe Connection OD/ID	mm	16/14
Power Supply	Suggested Fuse Size	V/ph/Hz-A	220-240/1/50-5
Remote Controller	WH-TA09NE (Infra-Red)		

### Accessories

<a href="#">RBC-AMTU31-E</a>	Standard Remote Controller - Full control including service functions
<a href="#">RBC-ASCU11-E</a>	Compact Remote Controller - Includes timer off, back light display, multilingual
<a href="#">RBC-AMSU51-E</a>	Standard Remote Controller - Includes timer, back light display, power-save functions, multilingual
<a href="#">RBC-AWSU52-E</a>	Premium Controller - Includes timer and back light display, multilingual (inc. Bluetooth)
<a href="#">RBC-MTSC1</a>	Mini Touch Screen Controller - with configurable icons for indoor units
<a href="#">RBC-MTSC2</a>	Mini Touch Screen Controller - with Schedule Timer, configurable icons for indoor units

\*All [Accessories](#) / [Controls](#)

Compatible R410a outdoor condensers:

[Mini SMMS-e](#), [SMMS-u](#), [SHRM-e](#)

Compatible R32 outdoor condensers:

[Mini SMMS](#), [SHRM-a](#)

Related items:

- [Full specification](#)
- [BIM files](#)
- [CAD files](#)
- [Airflow/ fan curve](#)
- [Dimensional drawing](#)
- [Wiring diagram](#)
- [Noise curve data](#)
- [Installation manual](#)

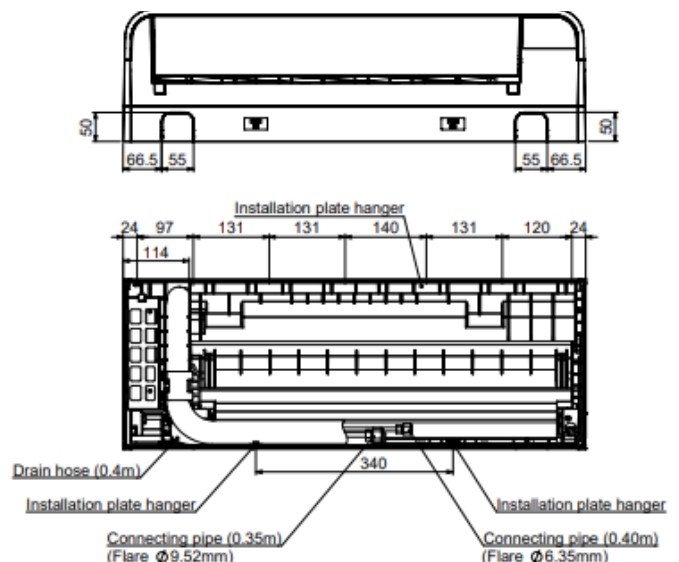



## VRF STANDARD HIGH WALL: MMK - UP0051HP-E

- Special fin coating for healthy & fresh air.
- New appearance, simple, elegant with led display.
- Perfect for limited spaces, such as offices or small shops.
- Filters for dust collection can be easily removed and easily cleaned.
- New compact design (only 293x798x230 mm) and lightweight (11 kg).



Hi - Res Image

### Performance Data

Capacity Code		HP	0.6
Nominal	Cooling Capacity	kW	1.7
	Heating Capacity	kW	1.9
UK	Cooling Total/Sensible	kW	1.5/1.4
	Heating	kW	1.3
Electrical	Power Input	kW	0.015
	Run Current	Amps	0.15
	Start Current	Amps	0.19

### Indoor Data

Airflow	High - Medium - Low	l/s	126 - 103 - 75
	High - Medium - Low	m3/h	455 - 370 - 270
Sound	Pressure High - Medium - Low	dB(A)	33 - 29 - 25
	Power High - Medium - Low	dB(A)	48 - 44 - 40
Unit	Height x Width x Depth	mm	293 x 798 x 230
	Weight	kg	11
Pipe Connection	Flare Connections (gas - liquid)	inch	3/8 - 1/4
	Drain Pipe Connection OD/ID	mm	16/14
Power Supply	Suggested Fuse Size	V/ph/Hz-A	220-240/1/50-5
Remote Controller	WH-TA09NE (Infra-Red)		

### Accessories

<a href="#">RBC-AMTU31-E</a>	Standard Remote Controller - Full control including service functions
<a href="#">RBC-ASCU11-E</a>	Compact Remote Controller - Includes timer off, back light display, multilingual
<a href="#">RBC-AMSU51-E</a>	Standard Remote Controller - Includes timer, back light display, power-save functions, multilingual
<a href="#">RBC-AWSU52-E</a>	Premium Controller - Includes timer and back light display, multilingual (inc. Bluetooth)
<a href="#">RBC-MTSC1</a>	Mini Touch Screen Controller - with configurable icons for indoor units
<a href="#">RBC-MTSC2</a>	Mini Touch Screen Controller - with Schedule Timer, configurable icons for indoor units

\*All [Accessories](#) / [Controls](#)

Compatible R410a outdoor condensers:

[Mini SMMS-e](#), [SMMS-u](#), [SHRM-e](#)

Compatible R32 outdoor condensers:

[Mini SMMS](#), [SHRM-a](#)

Related items:

- [Full specification](#)
- [BIM files](#)
- [CAD files](#)
- [Airflow/ fan curve](#)
- [Dimensional drawing](#)
- [Wiring diagram](#)
- [Noise curve data](#)
- [Installation manual](#)

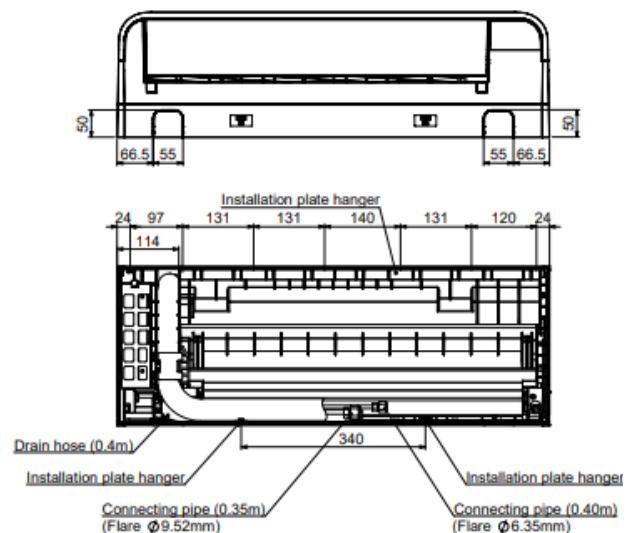

## VRF STANDARD HIGH WALL: MMK - UP0071HP-E

- Special fin coating for healthy & fresh air.
- New appearance, simple, elegant with led display.
- Perfect for limited spaces, such as offices or small shops.
- Filters for dust collection can be easily removed and easily cleaned.
- New compact design (only 293x798x230 mm) and lightweight (11 kg).



Hi - Res Image

### Performance Data

Capacity Code		HP	0.8
Nominal	Cooling Capacity	kW	2.2
	Heating Capacity	kW	2.5
UK	Cooling Total/Sensible	kW	2.0/1.6
	Heating	kW	1.7
Electrical	Power Input	kW	0.015
	Run Current	Amps	0.16
	Start Current	Amps	0.20

### Indoor Data

Airflow	High - Medium - Low	l/s	133 - 107 - 75
	High - Medium - Low	m3/h	480 - 385 - 270
Sound	Pressure High - Medium - Low	dB(A)	35 - 30 - 25
	Power High - Medium - Low	dB(A)	50 - 45 - 40
Unit	Height x Width x Depth	mm	293 x 798 x 230
	Weight	kg	11
Pipe Connection	Flare Connections (gas - liquid)	inch	3/8 - 1/4
	Drain Pipe Connection OD/ID	mm	16/14
Power Supply	Suggested Fuse Size	V/ph/Hz-A	220-240/1/50-5
Remote Controller	WH-TA09NE (Infra-Red)		

### Accessories

<a href="#">RBC-AMTU31-E</a>	Standard Remote Controller - Full control including service functions
<a href="#">RBC-ASCU11-E</a>	Compact Remote Controller - Includes timer off, back light display, multilingual
<a href="#">RBC-AMSU51-E</a>	Standard Remote Controller - Includes timer, back light display, power-save functions, multilingual
<a href="#">RBC-AWSU52-E</a>	Premium Controller - Includes timer and back light display, multilingual (inc. Bluetooth)
<a href="#">RBC-MTSC1</a>	Mini Touch Screen Controller - with configurable icons for indoor units
<a href="#">RBC-MTSC2</a>	Mini Touch Screen Controller - with Schedule Timer, configurable icons for indoor units

\*All [Accessories](#) / [Controls](#)

Compatible R410a outdoor condensers:

[Mini SMMS-e](#), [SMMS-u](#), [SHRM-e](#)

Compatible R32 outdoor condensers:

[Mini SMMS](#), [SHRM-a](#)

Related items:

- [Full specification](#)
- [BIM files](#)
- [CAD files](#)
- [Airflow/ fan curve](#)
- [Dimensional drawing](#)
- [Wiring diagram](#)
- [Noise curve data](#)
- [Installation manual](#)

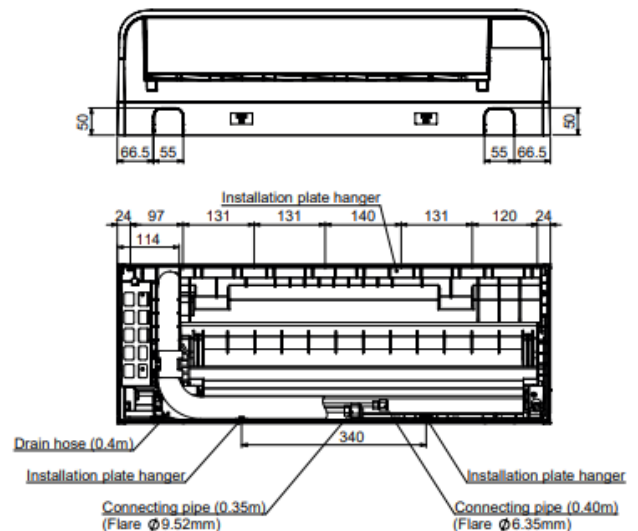

## VRF STANDARD HIGH WALL: MMK - UP0091HP-E

- Special fin coating for healthy & fresh air.
- New appearance, simple, elegant with led display.
- Perfect for limited spaces, such as offices or small shops.
- Filters for dust collection can be easily removed and easily cleaned.
- New compact design (only 293x798x230 mm) and lightweight (11 kg).



Hi - Res Image

### Performance Data

Capacity Code		HP	1.0
Nominal	Cooling Capacity	kW	2.8
	Heating Capacity	kW	3.2
UK	Cooling Total/Sensible	kW	2.5/1.9
	Heating	kW	2.2
Electrical	Power Input	kW	0.016
	Run Current	Amps	0.17
	Start Current	Amps	0.21

### Indoor Data

Airflow	High - Medium - Low	l/s	141 - 110 - 75
	High - Medium - Low	m3/h	510 - 395 - 270
Sound	Pressure High - Medium - Low	dB(A)	36 - 31 - 25
	Power High - Medium - Low	dB(A)	51 - 46 - 40
Unit	Height x Width x Depth	mm	293 x 798 x 230
	Weight	kg	11
Pipe Connection	Flare Connections (gas - liquid)	inch	3/8 - 1/4
	Drain Pipe Connection OD/ID	mm	16/14
Power Supply	Suggested Fuse Size	V/ph/Hz-A	220-240/1/50-5
Remote Controller	WH-TA09NE (Infra-Red)		

### Accessories

<a href="#">RBC-AMTU31-E</a>	Standard Remote Controller - Full control including service functions
<a href="#">RBC-ASCU11-E</a>	Compact Remote Controller - Includes timer off, back light display, multilingual
<a href="#">RBC-AMSU51-E</a>	Standard Remote Controller - Includes timer, back light display, power-save functions, multilingual
<a href="#">RBC-AWSU52-E</a>	Premium Controller - Includes timer and back light display, multilingual (inc. Bluetooth)
<a href="#">RBC-MTSC1</a>	Mini Touch Screen Controller - with configurable icons for indoor units
<a href="#">RBC-MTSC2</a>	Mini Touch Screen Controller - with Schedule Timer, configurable icons for indoor units

\*All [Accessories](#) / [Controls](#)

Compatible R410a outdoor condensers:

[Mini SMMS-e](#), [SMMS-u](#), [SHRM-e](#)

Compatible R32 outdoor condensers:

[Mini SMMS](#), [SHRM-a](#)

Related items:

- [Full specification](#)
- [BIM files](#)
- [CAD files](#)
- [Airflow/ fan curve](#)
- [Dimensional drawing](#)
- [Wiring diagram](#)
- [Noise curve data](#)
- [Installation manual](#)

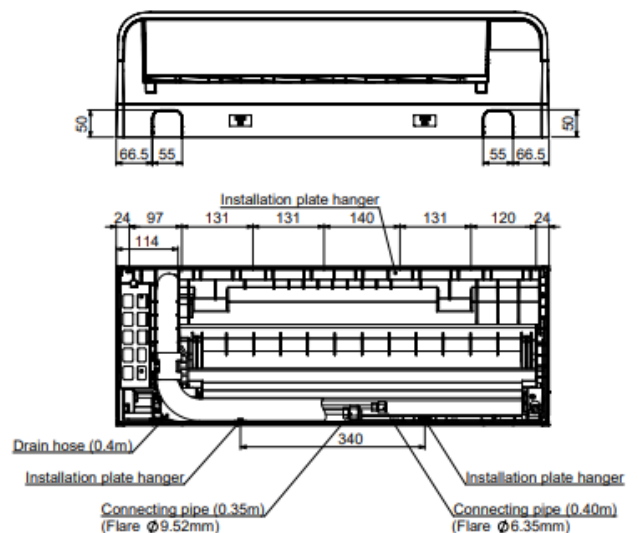

## VRF STANDARD HIGH WALL: MMK - UP0121HP-E

- Special fin coating for healthy & fresh air.
- New appearance, simple, elegant with led display.
- Perfect for limited spaces, such as offices or small shops.
- Filters for dust collection can be easily removed and easily cleaned.
- New compact design (only 293x798x230 mm) and lightweight (11 kg).



Hi - Res Image

### Performance Data

Capacity Code		HP	1.25
Nominal	Cooling Capacity	kW	3.6
	Heating Capacity	kW	4.0
UK	Cooling Total/Sensible	kW	3.3/2.4
	Heating	kW	2.7
Electrical	Power Input	kW	0.017
	Run Current	Amps	0.18
	Start Current	Amps	0.22

### Indoor Data

Airflow	High - Medium - Low	l/s	150 - 114 - 75
	High - Medium - Low	m3/h	540 - 410 - 270
Sound	Pressure High - Medium - Low	dB(A)	37 - 32 - 25
	Power High - Medium - Low	dB(A)	52 - 47 - 40
Unit	Height x Width x Depth	mm	293 x 798 x 230
	Weight	kg	11
Pipe Connection	Flare Connections (gas - liquid)	inch	3/8 - 1/4
	Drain Pipe Connection OD/ID	mm	16/14
Power Supply	Suggested Fuse Size	V/ph/Hz-A	220-240/1/50-5
Remote Controller	WH-TA09NE (Infra-Red)		

### Accessories

<a href="#">RBC-AMTU31-E</a>	Standard Remote Controller - Full control including service functions
<a href="#">RBC-ASCU11-E</a>	Compact Remote Controller - Includes timer off, back light display, multilingual
<a href="#">RBC-AMSU51-E</a>	Standard Remote Controller - Includes timer, back light display, power-save functions, multilingual
<a href="#">RBC-AWSU52-E</a>	Premium Controller - Includes timer and back light display, multilingual (inc. Bluetooth)
<a href="#">RBC-MTSC1</a>	Mini Touch Screen Controller - with configurable icons for indoor units
<a href="#">RBC-MTSC2</a>	Mini Touch Screen Controller - with Schedule Timer, configurable icons for indoor units

\*All [Accessories](#) / [Controls](#)

Compatible R410a outdoor condensers:

[Mini SMMS-e](#), [SMMS-u](#), [SHRM-e](#)

Compatible R32 outdoor condensers:

[Mini SMMS](#), [SHRM-a](#)

Related items:

- [Full specification](#)
- [BIM files](#)
- [CAD files](#)
- [Airflow/ fan curve](#)
- [Dimensional drawing](#)
- [Wiring diagram](#)
- [Noise curve data](#)
- [Installation manual](#)

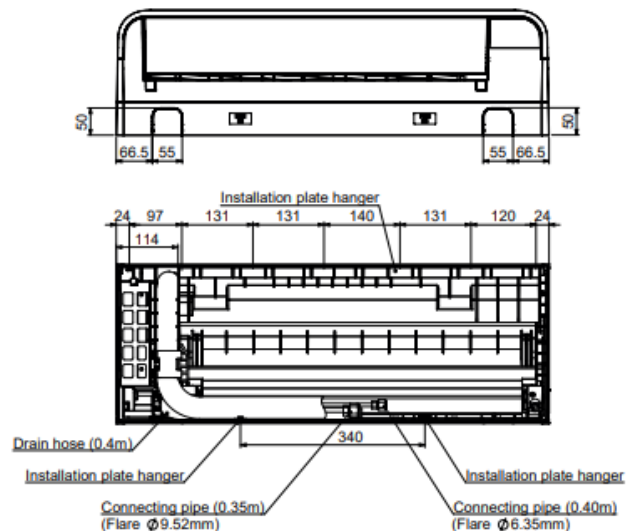

## VRF STANDARD HIGH WALL: MMK - UP0151HP-E

- Special fin coating for healthy & fresh air.
- New appearance, simple, elegant with led display.
- Perfect for limited spaces, such as offices or small shops.
- Filters for dust collection can be easily removed and easily cleaned.
- New compact design (only 293 x 1050 x 250 mm) and lightweight (16 kg).



Hi - Res Image

### Performance Data

Capacity Code		HP	1.7
Nominal	Cooling Capacity	kW	4.5
	Heating Capacity	kW	5.0
UK	Cooling Total/Sensible	kW	4.1/3.0
	Heating	kW	3.4
Electrical	Power Input	kW	0.028
	Run Current	Amps	0.26
	Start Current	Amps	0.35

### Indoor Data

Airflow	High - Medium - Low	l/s	233 - 192 - 153
	High - Medium - Low	m3/h	840 - 690 - 550
Sound	Pressure High - Medium - Low	dB(A)	40 - 36 - 32
	Power High - Medium - Low	dB(A)	55 - 51 - 47
Unit	Height x Width x Depth	mm	293 x 1050 x 250
	Weight	kg	16
Pipe Connection	Flare Connections (gas - liquid)	inch	1/2 - 1/4
	Drain Pipe Connection OD/ID	mm	16/14
Power Supply	Suggested Fuse Size	V/ph/Hz-A	220-240/1/50-5
Remote Controller	WH-TA09NE (Infra-Red)		

### Accessories

<a href="#">RBC-AMTU31-E</a>	Standard Remote Controller - Full control including service functions
<a href="#">RBC-ASCU11-E</a>	Compact Remote Controller - Includes timer off, back light display, multilingual
<a href="#">RBC-AMSU51-E</a>	Standard Remote Controller - Includes timer, back light display, power-save functions, multilingual
<a href="#">RBC-AWSU52-E</a>	Premium Controller - Includes timer and back light display, multilingual (inc. Bluetooth)
<a href="#">RBC-MTSC1</a>	Mini Touch Screen Controller - with configurable icons for indoor units
<a href="#">RBC-MTSC2</a>	Mini Touch Screen Controller - with Schedule Timer, configurable icons for indoor units

\*All [Accessories](#) / [Controls](#)

Compatible R410a outdoor condensers:

**[Mini SMMS-e](#), [SMMS-u](#), [SHRM-e](#)**

Compatible R32 outdoor condensers:

**[Mini SMMS](#), [SHRM-a](#)**

Related items:

- [Full specification](#)
- [BIM files](#)
- [CAD files](#)
- [Airflow/ fan curve](#)
- [Dimensional drawing](#)
- [Wiring diagram](#)
- [Noise curve data](#)
- [Installation manual](#)

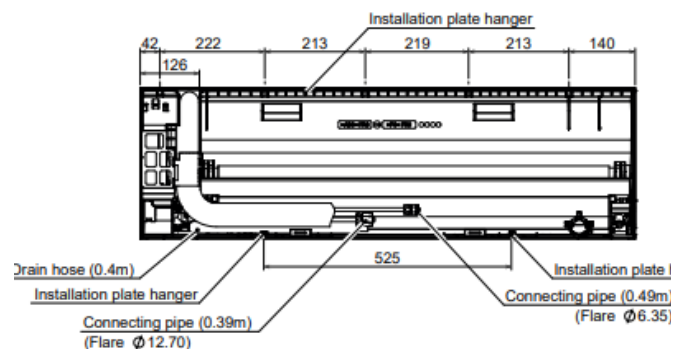
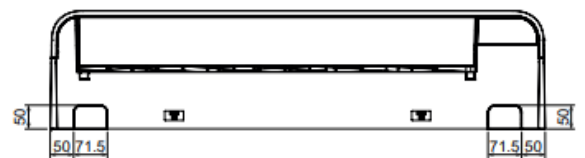

## VRF STANDARD HIGH WALL: MMK - UP0181HP-E

- Special fin coating for healthy & fresh air.
- New appearance, simple, elegant with led display.
- Perfect for limited spaces, such as offices or small shops.
- Filters for dust collection can be easily removed and easily cleaned.
- New compact design (only 293 x 1050 x 250 mm) and lightweight (16 kg).



Hi - Res Image

### Performance Data

Capacity Code		HP	2.0
Nominal	Cooling Capacity	kW	5.6
	Heating Capacity	kW	6.3
UK	Cooling Total/Sensible	kW	5.1/3.7
	Heating	kW	4.3
Electrical	Power Input	kW	0.032
	Run Current	Amps	0.29
	Start Current	Amps	0.38

### Indoor Data

Airflow	High - Medium - Low	l/s	250 - 200 - 153
	High - Medium - Low	m3/h	900 - 720 - 550
Sound	Pressure High - Medium - Low	dB(A)	41 - 37 - 32
	Power High - Medium - Low	dB(A)	56 - 52 - 47
Unit	Height x Width x Depth	mm	293 x 1050 x 250
	Weight	kg	16
Pipe Connection	Flare Connections (gas - liquid)	inch	1/2 - 1/4
	Drain Pipe Connection OD/ID	mm	16/14
Power Supply	Suggested Fuse Size	V/ph/Hz-A	220-240/1/50-5
Remote Controller	WH-TA09NE (Infra-Red)		

### Accessories

<a href="#">RBC-AMTU31-E</a>	Standard Remote Controller - Full control including service functions
<a href="#">RBC-ASCU11-E</a>	Compact Remote Controller - Includes timer off, back light display, multilingual
<a href="#">RBC-AMSU51-E</a>	Standard Remote Controller - Includes timer, back light display, power-save functions, multilingual
<a href="#">RBC-AWSU52-E</a>	Premium Controller - Includes timer and back light display, multilingual (inc. Bluetooth)
<a href="#">RBC-MTSC1</a>	Mini Touch Screen Controller - with configurable icons for indoor units
<a href="#">RBC-MTSC2</a>	Mini Touch Screen Controller - with Schedule Timer, configurable icons for indoor units

\*All [Accessories](#) / [Controls](#)

Compatible R410a outdoor condensers:

[Mini SMMS-e](#), [SMMS-u](#), [SHRM-e](#)

Compatible R32 outdoor condensers:

[Mini SMMS](#), [SHRM-a](#)

Related items:

- [Full specification](#)
- [BIM files](#)
- [CAD files](#)
- [Airflow/ fan curve](#)
- [Dimensional drawing](#)
- [Wiring diagram](#)
- [Noise curve data](#)
- [Installation manual](#)

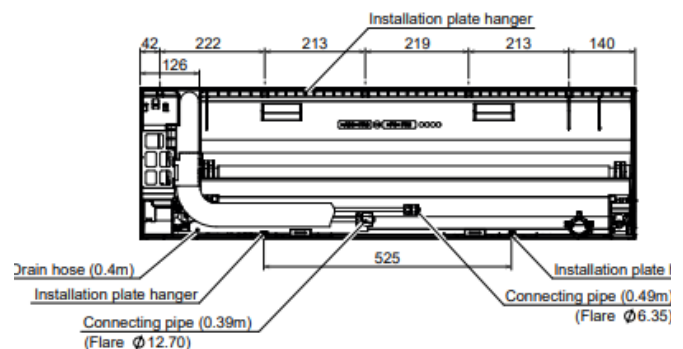

## VRF STANDARD HIGH WALL: MMK - UP0241HP-E

- Special fin coating for healthy & fresh air.
- New appearance, simple, elegant with led display.
- Perfect for limited spaces, such as offices or small shops.
- Filters for dust collection can be easily removed and easily cleaned.
- New compact design (only 293 x 1050 x 250 mm) and lightweight (16 kg).



Hi - Res Image

### Performance Data

Capacity Code		HP	2.5
Nominal	Cooling Capacity	kW	7.1
	Heating Capacity	kW	8.0
UK	Cooling Total/Sensible	kW	6.4/4.7
	Heating	kW	5.4
Electrical	Power Input	kW	0.050
	Run Current	Amps	0.40
	Start Current	Amps	0.50

### Indoor Data

Airflow	High - Medium - Low	l/s	333 - 250 - 167
	High - Medium - Low	m3/h	1200 - 900 - 600
Sound	Pressure High - Medium - Low	dB(A)	45 - 39 - 33
	Power High - Medium - Low	dB(A)	60 - 54 - 48
Unit	Height x Width x Depth	mm	293 x 1050 x 250
	Weight	kg	16
Pipe Connection	Flare Connections (gas - liquid)	inch	5/8 - 3/8
	Drain Pipe Connection OD/ID	mm	16/14
Power Supply	Suggested Fuse Size	V/ph/Hz-A	220-240/1/50-5
Remote Controller	WH-TA09NE (Infra-Red)		

### Accessories

<a href="#">RBC-AMTU31-E</a>	Standard Remote Controller - Full control including service functions
<a href="#">RBC-ASCU11-E</a>	Compact Remote Controller - Includes timer off, back light display, multilingual
<a href="#">RBC-AMSU51-E</a>	Standard Remote Controller - Includes timer, back light display, power-save functions, multilingual
<a href="#">RBC-AWSU52-E</a>	Premium Controller - Includes timer and back light display, multilingual (inc. Bluetooth)
<a href="#">RBC-MTSC1</a>	Mini Touch Screen Controller - with configurable icons for indoor units
<a href="#">RBC-MTSC2</a>	Mini Touch Screen Controller - with Schedule Timer, configurable icons for indoor units

\*All [Accessories](#) / [Controls](#)

Compatible R410a outdoor condensers:

[Mini SMMS-e](#), [SMMS-u](#), [SHRM-e](#)

Compatible R32 outdoor condensers:

[Mini SMMS](#), [SHRM-a](#)

Related items:

- [Full specification](#)
- [BIM files](#)
- [CAD files](#)
- [Airflow/ fan curve](#)
- [Dimensional drawing](#)
- [Wiring diagram](#)
- [Noise curve data](#)
- [Installation manual](#)

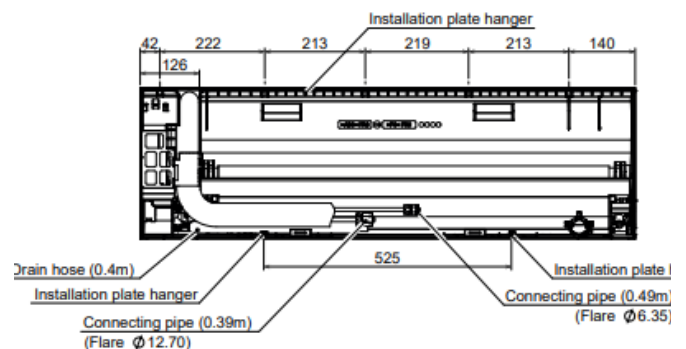
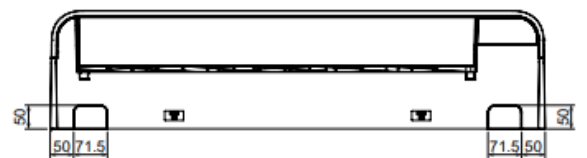

## VRF STANDARD HIGH WALL: MMK - UP0271HP-E

- Special fin coating for healthy & fresh air.
- New appearance, simple, elegant with led display.
- Perfect for limited spaces, such as offices or small shops.
- Filters for dust collection can be easily removed and easily cleaned.
- New compact design (only 348 x 1200 x 280 mm) and lightweight (21 kg).



Hi - Res Image

### Performance Data

Capacity Code		HP	3.0
Nominal	Cooling Capacity	kW	8.0
	Heating Capacity	kW	9.0
UK	Cooling Total/Sensible	kW	7.1/5.6
	Heating	kW	6.1
Electrical	Power Input	kW	0.034
	Run Current	Amps	0.03
	Start Current	Amps	0.34

### Indoor Data

Airflow	High - Medium - Low	l/s	333 - 277 - 222
	High - Medium - Low	m3/h	1200 - 1000 - 800
Sound	Pressure High - Medium - Low	dB(A)	45 - 41 - 39
	Power High - Medium - Low	dB(A)	60 - 56 - 54
Unit	Height x Width x Depth	mm	348 x 1200 x 280
	Weight	kg	21
Pipe Connection	Flare Connections (gas - liquid)	inch	5/8 - 3/8
	Drain Pipe Connection OD/ID	mm	16/14
Power Supply	Suggested Fuse Size	V/ph/Hz-A	220-240/1/50-5
Remote Controller	WH-TA09NE (Infra-Red)		

### Accessories

<a href="#">RBC-AMTU31-E</a>	Standard Remote Controller - Full control including service functions
<a href="#">RBC-ASCU11-E</a>	Compact Remote Controller - Includes timer off, back light display, multilingual
<a href="#">RBC-AMSU51-E</a>	Standard Remote Controller - Includes timer, back light display, power-save functions, multilingual
<a href="#">RBC-AWSU52-E</a>	Premium Controller - Includes timer and back light display, multilingual (inc. Bluetooth)
<a href="#">RBC-MTSC1</a>	Mini Touch Screen Controller - with configurable icons for indoor units
<a href="#">RBC-MTSC2</a>	Mini Touch Screen Controller - with Schedule Timer, configurable icons for indoor units

\*All [Accessories](#) / [Controls](#)

Compatible R410a outdoor condensers:

**[Mini SMMS-e](#), [SMMS-u](#), [SHRM-e](#)**

Compatible R32 outdoor condensers:

**[Mini SMMS](#), [SHRM-a](#)**

Related items:

- [Full specification](#)
- [CAD files](#)
- [Airflow/ fan curve](#)
- [Dimensional drawing](#)
- [Wiring diagram](#)
- [Noise curve data](#)
- [Installation manual](#)

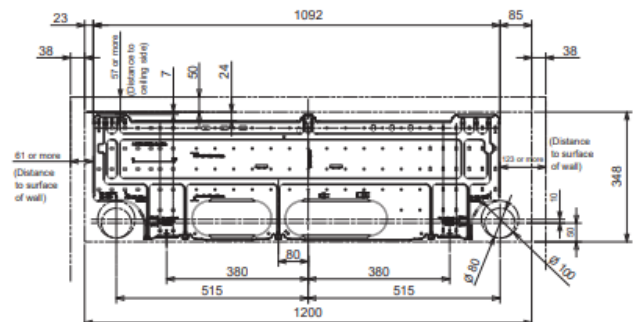



## VRF STANDARD HIGH WALL: MMK - UP0301HP-E

- Special fin coating for healthy & fresh air.
- New appearance, simple, elegant with led display.
- Perfect for limited spaces, such as offices or small shops.
- Filters for dust collection can be easily removed and easily cleaned.
- New compact design (only 348 x 1200 x 280 mm) and lightweight (21 kg).



Hi - Res Image

### Performance Data

Capacity Code		HP	3.2
Nominal	Cooling Capacity	kW	9
	Heating Capacity	kW	10
UK	Cooling Total/Sensible	kW	8.0/6.3
	Heating	kW	6.8
Electrical	Power Input	kW	0.054
	Run Current	Amps	0.05
	Start Current	Amps	0.5

### Indoor Data

Airflow	High - Medium - Low	l/s	403 - 361 - 305
	High - Medium - Low	m3/h	1500 - 1300 - 1100
Sound	Pressure High - Medium - Low	dB(A)	48 - 44 - 41
	Power High - Medium - Low	dB(A)	63 - 59 - 56
Unit	Height x Width x Depth	mm	348 x 1200 x 280
	Weight	kg	21
Pipe Connection	Flare Connections (gas - liquid)	inch	5/8 - 3/8
	Drain Pipe Connection OD/ID	mm	16/14
Power Supply	Suggested Fuse Size	V/ph/Hz-A	220-240/1/50-5
Remote Controller	WH-TA09NE (Infra-Red)		

### Accessories

<a href="#">RBC-AMTU31-E</a>	Standard Remote Controller - Full control including service functions
<a href="#">RBC-ASCU11-E</a>	Compact Remote Controller - Includes timer off, back light display, multilingual
<a href="#">RBC-AMSU51-E</a>	Standard Remote Controller - Includes timer, back light display, power-save functions, multilingual
<a href="#">RBC-AWSU52-E</a>	Premium Controller - Includes timer and back light display, multilingual (inc. Bluetooth)
<a href="#">RBC-MTSC1</a>	Mini Touch Screen Controller - with configurable icons for indoor units
<a href="#">RBC-MTSC2</a>	Mini Touch Screen Controller - with Schedule Timer, configurable icons for indoor units

\*All [Accessories](#) / [Controls](#)

Compatible R410a outdoor condensers:

**[Mini SMMS-e](#), [SMMS-u](#), [SHRM-e](#)**

Compatible R32 outdoor condensers:

**[Mini SMMS](#), [SHRM-a](#)**

Related items:

- [Full specification](#)
- [CAD files](#)
- [Airflow/ fan curve](#)
- [Dimensional drawing](#)
- [Wiring diagram](#)
- [Noise curve data](#)
- [Installation manual](#)

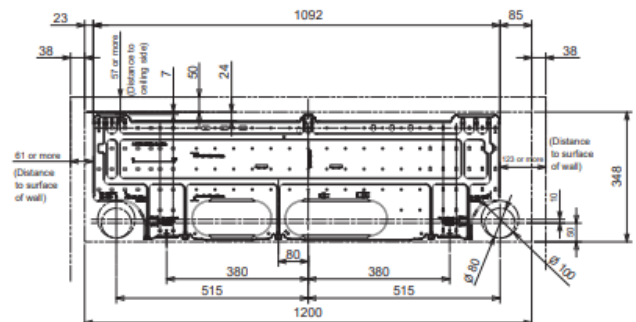

## VRF STANDARD HIGH WALL: MMK - UP0361HP-E

- Special fin coating for healthy & fresh air.
- New appearance, simple, elegant with led display.
- Perfect for limited spaces, such as offices or small shops.
- Filters for dust collection can be easily removed and easily cleaned.
- New compact design (only 348 x 1200 x 280 mm) and lightweight (21 kg).



Hi - Res Image

### Performance Data

Capacity Code		HP	4.0
Nominal	Cooling Capacity	kW	10
	Heating Capacity	kW	11.2
UK	Cooling Total/Sensible	kW	10.0/7.8
	Heating	kW	8.5
Electrical	Power Input	kW	0.066
	Run Current	Amps	0.06
	Start Current	Amps	0.6

### Indoor Data

Airflow	High - Medium - Low	l/s	458 - 375 - 347
	High - Medium - Low	m <sup>3</sup> /h	1650 - 1350 - 1250
Sound	Pressure High - Medium - Low	dB(A)	50 - 45 - 43
	Power High - Medium - Low	dB(A)	65 - 60 - 58
Unit	Height x Width x Depth	mm	348 x 1200 x 280
	Weight	kg	21
Pipe Connection	Flare Connections (gas - liquid)	inch	5/8 - 3/8
	Drain Pipe Connection OD/ID	mm	16/14
Power Supply	Suggested Fuse Size	V/ph/Hz-A	220-240/1/50-5
Remote Controller	WH-TA09NE (Infra-Red)		

### Accessories

<a href="#">RBC-AMTU31-E</a>	Standard Remote Controller - Full control including service functions
<a href="#">RBC-ASCU11-E</a>	Compact Remote Controller - Includes timer off, back light display, multilingual
<a href="#">RBC-AMSU51-E</a>	Standard Remote Controller - Includes timer, back light display, power-save functions, multilingual
<a href="#">RBC-AWSU52-E</a>	Premium Controller - Includes timer and back light display, multilingual (inc. Bluetooth)
<a href="#">RBC-MTSC1</a>	Mini Touch Screen Controller - with configurable icons for indoor units
<a href="#">RBC-MTSC2</a>	Mini Touch Screen Controller - with Schedule Timer, configurable icons for indoor units

\*All [Accessories](#) / [Controls](#)

Compatible R410a outdoor condensers:

[Mini SMMS-e](#), [SMMS-u](#), [SHRM-e](#)

Compatible R32 outdoor condensers:

[Mini SMMS](#), [SHRM-a](#)

Related items:

- [Full specification](#)
- [CAD files](#)
- [Airflow/ fan curve](#)
- [Dimensional drawing](#)
- [Wiring diagram](#)
- [Noise curve data](#)
- [Installation manual](#)

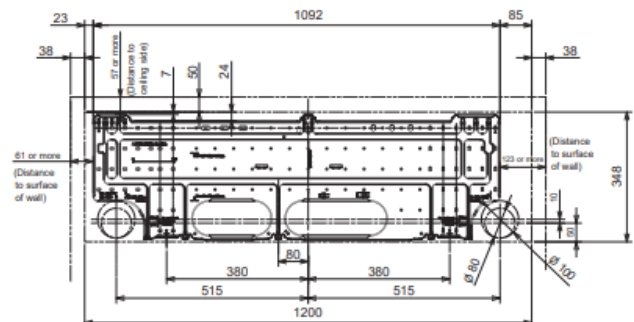

# Premium High Wall



## VRF PREMIUM HIGH WALL: MMK - UP0051DHPL-E

- Suitable for noise sensitive areas with use of PMV Kit.
- Toshiba Ultra Pure Filter captures up to 94% of PM 2.5.
- Pleasing aesthetic design including luxury style remote.
- Fabrics with infinite possibilities, let your style be your guide.
- Toshiba Plasma Ionizer catches and neutralizes the contaminated particles.



Hi - Res Image 



### Performance Data

Capacity Code		HP	0.6
Nominal	Cooling Capacity	kW	1.7
	Heating Capacity	kW	1.9
UK	Cooling Total/Sensible	kW	1.5/1.4
	Heating	kW	1.3
Electrical	Power Input	kW	0.015
	Run Current	Amps	0.17
	Start Current	Amps	0.22

### Indoor Data

Airflow	High - Medium - Low	l/s	126 - 103 - 83
	High - Medium - Low	m3/h	455 - 370 - 300
Sound	Pressure High - Medium - Low	dB(A)	33 - 29 - 25
	Power High	dB(A)	48
Unit	Height x Width x Depth	mm	300 x 987 x 210
	Weight	kg	11
Pipe Connection	Flare Connections (gas - liquid)	inch	3/8 - 1/4
	Drain Pipe Connection OD/ID	mm	16/14
Power Supply	Suggested Fuse Size	V/ph/Hz-A	220-240/1/50-5
Remote Controller	WH-UB01UE (Infra-Red)		

### Accessories

<a href="#">RBC-AMTU31-E</a>	Standard Remote Controller - Full control including service functions
<a href="#">RBC-ASCU11-E</a>	Compact Remote Controller - Includes timer off, back light display, multilingual
<a href="#">RBC-AWSU52-E</a>	Premium Controller - Includes timer and back light display, multilingual (inc. Bluetooth)
<a href="#">RBC-MTSC1</a>	Mini Touch Screen Controller - with configurable icons for indoor units
<a href="#">RBC-MTSC2</a>	Mini Touch Screen Controller - with Schedule Timer, configurable icons for indoor units
<a href="#">RB-I410*-E</a>	Fabric Covers: Dark Grey, Light Grey, Blueish Grey, Grey Beige, Dark Brown, Emerald Blue
<a href="#">RBM-PMV0361UP-E</a>	PMV Kit for 0.6 - 1.25HP - For Models 003 - 012
<a href="#">RBM-PMV0901UP-E</a>	PMV Kit for 1.7 - 2.0HP - For Models 015 - 024

\*All [Accessories](#) / [Controls](#)

Compatible R410a outdoor condensers:

**[Mini SMMS-e](#), [SMMS-u](#), [SHRM-e](#)**

Compatible R32 outdoor condensers:

**[Mini SMMS](#), [SHRM-a](#)**

Related items:

- [Full specification](#)
- [Fabric pattern](#)
- [CAD files](#)
- [Airflow/ fan curve](#)
- [Dimensional drawing](#)
- [Wiring diagram](#)
- [Noise curve data](#)
- [Installation manual](#)

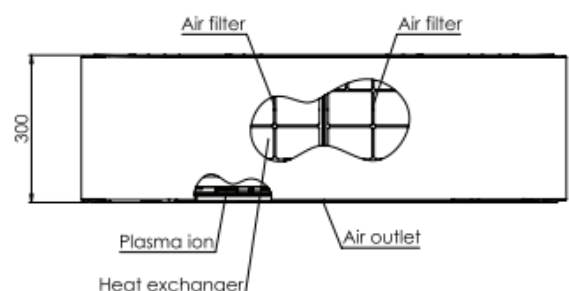
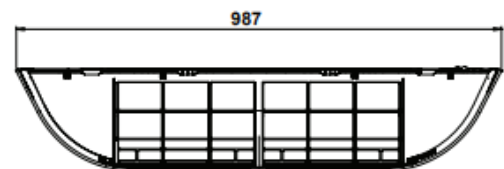

## VRF PREMIUM HIGH WALL: MMK - UP0071DHPL-E

- Suitable for noise sensitive areas with use of PMV Kit.
- Toshiba Ultra Pure Filter captures up to 94% of PM 2.5.
- Pleasing aesthetic design including luxury style remote.
- Fabrics with infinite possibilities, let your style be your guide.
- Toshiba Plasma Ionizer catches and neutralizes the contaminated particles.



Hi - Res Image 



### Performance Data

Capacity Code		HP	0.8
Nominal	Cooling Capacity	kW	2.2
	Heating Capacity	kW	2.5
UK	Cooling Total/Sensible	kW	2.0/1.6
	Heating	kW	1.7
Electrical	Power Input	kW	0.018
	Run Current	Amps	0.18
	Start Current	Amps	0.23

### Indoor Data

Airflow	High - Medium - Low	l/s	133 - 107 - 83
	High - Medium - Low	m3/h	480 - 385 - 300
Sound	Pressure High - Medium - Low	dB(A)	35 - 30 - 25
	Power High	dB(A)	50
Unit	Height x Width x Depth	mm	300 x 987 x 210
	Weight	kg	11
Pipe Connection	Flare Connections (gas - liquid)	inch	3/8 - 1/4
	Drain Pipe Connection OD/ID	mm	16/14
Power Supply	Suggested Fuse Size	V/ph/Hz-A	220-240/1/50-5
Remote Controller	WH-UB01UE (Infra-Red)		

### Accessories

<a href="#">RBC-AMTU31-E</a>	Standard Remote Controller - Full control including service functions
<a href="#">RBC-ASCU11-E</a>	Compact Remote Controller - Includes timer off, back light display, multilingual
<a href="#">RBC-AWSU52-E</a>	Premium Controller - Includes timer and back light display, multilingual (inc. Bluetooth)
<a href="#">RBC-MTSC1</a>	Mini Touch Screen Controller - with configurable icons for indoor units
<a href="#">RBC-MTSC2</a>	Mini Touch Screen Controller - with Schedule Timer, configurable icons for indoor units
<a href="#">RB-I410*-E</a>	Fabric Covers: Dark Grey, Light Grey, Blueish Grey, Grey Beige, Dark Brown, Emerald Blue
<a href="#">RBM-PMV0361UP-E</a>	PMV Kit for 0.6 - 1.25HP - For Models 003 - 012
<a href="#">RBM-PMV0901UP-E</a>	PMV Kit for 1.7 - 2.0HP - For Models 015 - 024

\*All [Accessories](#) / [Controls](#)

Compatible R410a outdoor condensers:

**[Mini SMMS-e](#), [SMMS-u](#), [SHRM-e](#)**

Compatible R32 outdoor condensers:

**[Mini SMMS](#), [SHRM-a](#)**

Related items:

- [Full specification](#)
- [Fabric pattern](#)
- [CAD files](#)
- [Airflow/ fan curve](#)
- [Dimensional drawing](#)
- [Wiring diagram](#)
- [Noise curve data](#)
- [Installation manual](#)

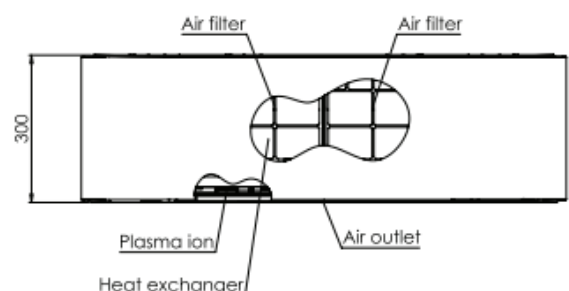
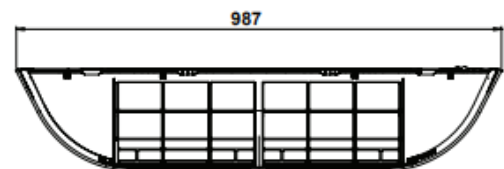

## VRF PREMIUM HIGH WALL: MMK - UP0091DHPL-E

- Suitable for noise sensitive areas with use of PMV Kit.
- Toshiba Ultra Pure Filter captures up to 94% of PM 2.5.
- Pleasing aesthetic design including luxury style remote.
- Fabrics with infinite possibilities, let your style be your guide.
- Toshiba Plasma Ionizer catches and neutralizes the contaminated particles.



Hi - Res Image 



### Performance Data

Capacity Code		HP	1.0
Nominal	Cooling Capacity	kW	2.8
	Heating Capacity	kW	3.2
UK	Cooling Total/Sensible	kW	2.5/1.9
	Heating	kW	2.2
Electrical	Power Input	kW	0.019
	Run Current	Amps	0.19
	Start Current	Amps	0.24

### Indoor Data

Airflow	High - Medium - Low	l/s	142 - 110 - 83
	High - Medium - Low	m3/h	510 - 395 - 300
Sound	Pressure High - Medium - Low	dB(A)	36 - 31 - 25
	Power High	dB(A)	51
Unit	Height x Width x Depth	mm	300 x 987 x 210
	Weight	kg	11
Pipe Connection	Flare Connections (gas - liquid)	inch	3/8 - 1/4
	Drain Pipe Connection OD/ID	mm	16/14
Power Supply	Suggested Fuse Size	V/ph/Hz-A	220-240/1/50-5
Remote Controller	WH-UB01UE (Infra-Red)		

### Accessories

<a href="#">RBC-AMTU31-E</a>	Standard Remote Controller - Full control including service functions
<a href="#">RBC-ASCU11-E</a>	Compact Remote Controller - Includes timer off, back light display, multilingual
<a href="#">RBC-AWSU52-E</a>	Premium Controller - Includes timer and back light display, multilingual (inc. Bluetooth)
<a href="#">RBC-MTSC1</a>	Mini Touch Screen Controller - with configurable icons for indoor units
<a href="#">RBC-MTSC2</a>	Mini Touch Screen Controller - with Schedule Timer, configurable icons for indoor units
<a href="#">RB-I410*-E</a>	Fabric Covers: Dark Grey, Light Grey, Blueish Grey, Grey Beige, Dark Brown, Emerald Blue
<a href="#">RBM-PMV0361UP-E</a>	PMV Kit for 0.6 - 1.25HP - For Models 003 - 012
<a href="#">RBM-PMV0901UP-E</a>	PMV Kit for 1.7 - 2.0HP - For Models 015 - 024

\*All [Accessories](#) / [Controls](#)

Compatible R410a outdoor condensers:

**[Mini SMMS-e](#), [SMMS-u](#), [SHRM-e](#)**

Compatible R32 outdoor condensers:

**[Mini SMMS](#), [SHRM-a](#)**

Related items:

- [Full specification](#)
- [Fabric pattern](#)
- [CAD files](#)
- [Airflow/ fan curve](#)
- [Dimensional drawing](#)
- [Wiring diagram](#)
- [Noise curve data](#)
- [Installation manual](#)

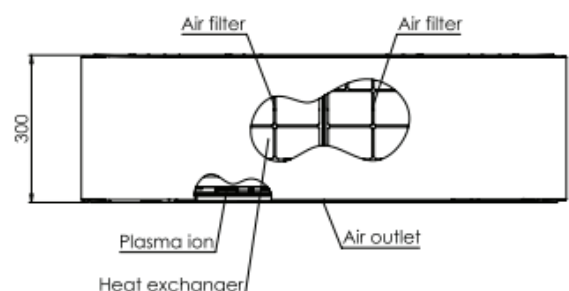
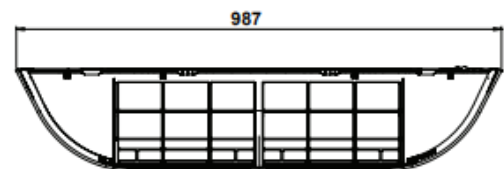

## VRF PREMIUM HIGH WALL: MMK - UP0121DHPL-E

- Suitable for noise sensitive areas with use of PMV Kit.
- Toshiba Ultra Pure Filter captures up to 94% of PM 2.5.
- Pleasing aesthetic design including luxury style remote.
- Fabrics with infinite possibilities, let your style be your guide.
- Toshiba Plasma Ionizer catches and neutralizes the contaminated particles.



Hi - Res Image 



### Performance Data

Capacity Code		HP	1.25
Nominal	Cooling Capacity	kW	3.6
	Heating Capacity	kW	4.0
UK	Cooling Total/Sensible	kW	3.3/2.4
	Heating	kW	2.7
Electrical	Power Input	kW	0.021
	Run Current	Amps	0.20
	Start Current	Amps	0.25

### Indoor Data

Airflow	High - Medium - Low	l/s	150 - 114 - 83
	High - Medium - Low	m3/h	540 - 410 - 300
Sound	Pressure High - Medium - Low	dB(A)	37 - 32 - 25
	Power High	dB(A)	52
Unit	Height x Width x Depth	mm	300 x 987 x 210
	Weight	kg	11
Pipe Connection	Flare Connections (gas - liquid)	inch	3/8 - 1/4
	Drain Pipe Connection OD/ID	mm	16/14
Power Supply	Suggested Fuse Size	V/ph/Hz-A	220-240/1/50-5
Remote Controller	WH-UB01UE (Infra-Red)		

### Accessories

<a href="#">RBC-AMTU31-E</a>	Standard Remote Controller - Full control including service functions
<a href="#">RBC-ASCU11-E</a>	Compact Remote Controller - Includes timer off, back light display, multilingual
<a href="#">RBC-AWSU52-E</a>	Premium Controller - Includes timer and back light display, multilingual (inc. Bluetooth)
<a href="#">RBC-MTSC1</a>	Mini Touch Screen Controller - with configurable icons for indoor units
<a href="#">RBC-MTSC2</a>	Mini Touch Screen Controller - with Schedule Timer, configurable icons for indoor units
<a href="#">RB-I410*-E</a>	Fabric Covers: Dark Grey, Light Grey, Blueish Grey, Grey Beige, Dark Brown, Emerald Blue
<a href="#">RBM-PMV0361UP-E</a>	PMV Kit for 0.6 - 1.25HP - For Models 003 - 012
<a href="#">RBM-PMV0901UP-E</a>	PMV Kit for 1.7 - 2.0HP - For Models 015 - 024

\*All [Accessories](#) / [Controls](#)

Compatible R410a outdoor condensers:

**[Mini SMMS-e](#), [SMMS-u](#), [SHRM-e](#)**

Compatible R32 outdoor condensers:

**[Mini SMMS](#), [SHRM-a](#)**

Related items:

- [Full specification](#)
- [Fabric pattern](#)
- [CAD files](#)
- [Airflow/ fan curve](#)
- [Dimensional drawing](#)
- [Wiring diagram](#)
- [Noise curve data](#)
- [Installation manual](#)

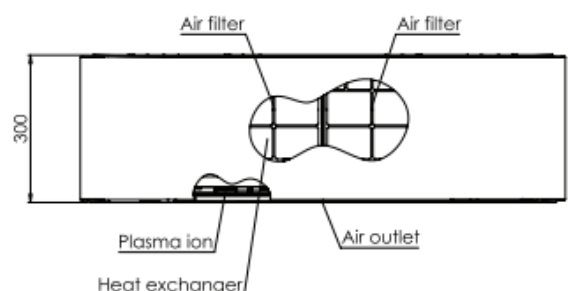
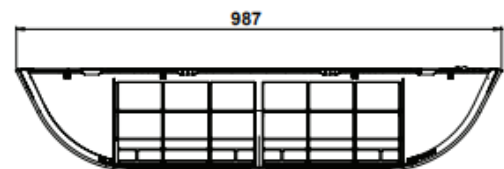

## VRF PREMIUM HIGH WALL: MMK - UP0151DHPL-E

- Suitable for noise sensitive areas with use of PMV Kit.
- Toshiba Ultra Pure Filter captures up to 94% of PM 2.5.
- Pleasing aesthetic design including luxury style remote.
- Fabrics with infinite possibilities, let your style be your guide.
- Toshiba Plasma Ionizer catches and neutralizes the contaminated particles.



Hi - Res Image 



### Performance Data

Capacity Code		HP	1.70
Nominal	Cooling Capacity	kW	4.5
	Heating Capacity	kW	5.0
UK	Cooling Total/Sensible	kW	4.1/3.0
	Heating	kW	3.4
Electrical	Power Input	kW	0.025
	Run Current	Amps	0.22
	Start Current	Amps	0.27

### Indoor Data

Airflow	High - Medium - Low	l/s	161 - 133 - 106
	High - Medium - Low	m3/h	580 - 480 - 380
Sound	Pressure High - Medium - Low	dB(A)	40 - 35 - 30
	Power High	dB(A)	55
Unit	Height x Width x Depth	mm	300 x 987 x 210
	Weight	kg	11
Pipe Connection	Flare Connections (gas - liquid)	inch	1/2 - 1/4
	Drain Pipe Connection OD/ID	mm	16/14
Power Supply	Suggested Fuse Size	V/ph/Hz-A	220-240/1/50-5
Remote Controller	WH-UB01UE (Infra-Red)		

### Accessories

<a href="#">RBC-AMTU31-E</a>	Standard Remote Controller - Full control including service functions
<a href="#">RBC-ASCU11-E</a>	Compact Remote Controller - Includes timer off, back light display, multilingual
<a href="#">RBC-AWSU52-E</a>	Premium Controller - Includes timer and back light display, multilingual (inc. Bluetooth)
<a href="#">RBC-MTSC1</a>	Mini Touch Screen Controller - with configurable icons for indoor units
<a href="#">RBC-MTSC2</a>	Mini Touch Screen Controller - with Schedule Timer, configurable icons for indoor units
<a href="#">RB-I410*-E</a>	Fabric Covers: Dark Grey, Light Grey, Blueish Grey, Grey Beige, Dark Brown, Emerald Blue
<a href="#">RBM-PMV0361UP-E</a>	PMV Kit for 0.6 - 1.25HP - For Models 003 - 012
<a href="#">RBM-PMV0901UP-E</a>	PMV Kit for 1.7 - 2.0HP - For Models 015 - 024

\*All [Accessories](#) / [Controls](#)

Compatible R410a outdoor condensers:

**[Mini SMMS-e](#), [SMMS-u](#), [SHRM-e](#)**

Compatible R32 outdoor condensers:

**[Mini SMMS](#), [SHRM-a](#)**

Related items:

- [Full specification](#)
- [Fabric pattern](#)
- [CAD files](#)
- [Airflow/ fan curve](#)
- [Dimensional drawing](#)
- [Wiring diagram](#)
- [Noise curve data](#)
- [Installation manual](#)

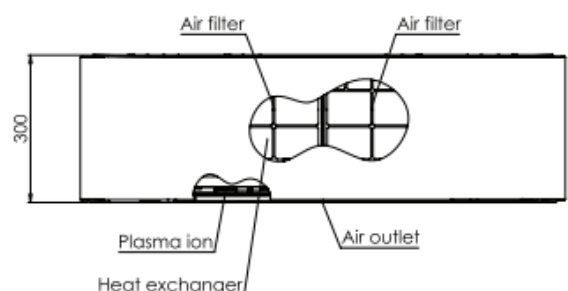
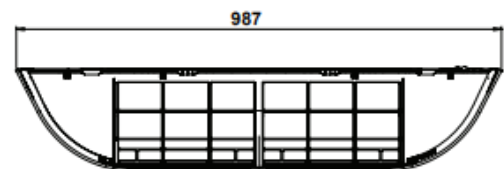



## VRF PREMIUM HIGH WALL: MMK -UP0181DHPL-E

- Suitable for noise sensitive areas with use of PMV Kit.
- Toshiba Ultra Pure Filter captures up to 94% of PM 2.5.
- Pleasing aesthetic design including luxury style remote.
- Fabrics with infinite possibilities, let your style be your guide.
- Toshiba Plasma Ionizer catches and neutralizes the contaminated particles.



Hi - Res Image 

### Performance Data

Capacity Code		HP	2.0
Nominal	Cooling Capacity	kW	5.6
	Heating Capacity	kW	6.3
UK	Cooling Total/Sensible	kW	5.1/3.7
	Heating	kW	4.3
Electrical	Power Input	kW	0.032
	Run Current	Amps	0.28
	Start Current	Amps	0.33

### Indoor Data

Airflow	High - Medium - Low	l/s	203 - 167 - 117
	High - Medium - Low	m3/h	730 - 600 - 420
Sound	Pressure High - Medium - Low	dB(A)	45 - 39 - 32
	Power High	dB(A)	60
Unit	Height x Width x Depth	mm	300 x 987 x 210
	Weight	kg	11
Pipe Connection	Flare Connections (gas - liquid)	inch	1/2 - 1/4
	Drain Pipe Connection OD/ID	mm	16/14
Power Supply	Suggested Fuse Size	V/ph/Hz-A	220-240/1/50-5
Remote Controller	WH-UB01UE (Infra-Red)		

### Accessories

<a href="#">RBC-AMTU31-E</a>	Standard Remote Controller - Full control including service functions
<a href="#">RBC-ASCU11-E</a>	Compact Remote Controller - Includes timer off, back light display, multilingual
<a href="#">RBC-AWSU52-E</a>	Premium Controller - Includes timer and back light display, multilingual (inc. Bluetooth)
<a href="#">RBC-MTSC1</a>	Mini Touch Screen Controller - with configurable icons for indoor units
<a href="#">RBC-MTSC2</a>	Mini Touch Screen Controller - with Schedule Timer, configurable icons for indoor units
<a href="#">RB-I410*-E</a>	Fabric Covers: Dark Grey, Light Grey, Blueish Grey, Grey Beige, Dark Brown, Emerald Blue
<a href="#">RBM-PMV0361UP-E</a>	PMV Kit for 0.6 - 1.25HP - For Models 003 - 012
<a href="#">RBM-PMV0901UP-E</a>	PMV Kit for 1.7 - 2.0HP - For Models 015 - 024

\*All [Accessories](#) / [Controls](#)

Compatible R410a outdoor condensers:

**[Mini SMMS-e](#), [SMMS-u](#), [SHRM-e](#)**

Compatible R32 outdoor condensers:

**[Mini SMMS](#), [SHRM-a](#)**

Related items:

- [Full specification](#)
- [Fabric pattern](#)
- [CAD files](#)
- [Airflow/ fan curve](#)
- [Dimensional drawing](#)
- [Wiring diagram](#)
- [Noise curve data](#)
- [Installation manual](#)

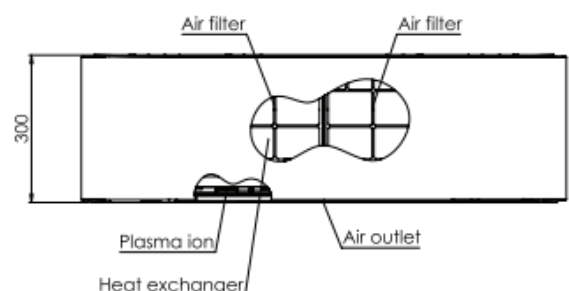
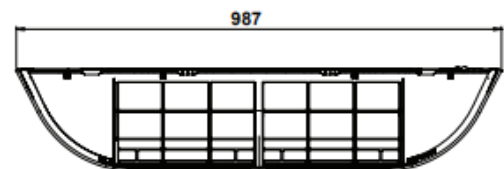

# 1-Way Slim Cassette



## VRF 1-WAY SLIM CASSETTE: MMU - UP0031YHP-E

- Advanced filtration available as an option.
- Ultra thin chassis (H x W x D) 150 x 990 x 450mm.
- Low noise level that can operate down to 25dB(A).
- Smart operation with Motion sensor available as an option.
- Ideal for false ceiling applications where the space for the unit is limited.



Hi - Res Image 



### Performance Data

Capacity Code		HP	0.3
Nominal	Cooling Capacity	kW	0.9
	Heating Capacity	kW	1.3
UK	Cooling Total/Sensible	kW	0.8/0.6
	Heating	kW	0.9
Electrical	Power Input	kW	0.015
	Run Current	Amps	0.15
	Start Current	Amps	0.40

### Indoor Data

Airflow	High - Medium - Low	l/s	133 - 102 - 75
	High - Medium - Low	m3/h	480 - 370 - 270
Sound	Pressure High - Medium - Low	dB(A)	37 - 33 - 25
	Power High - Medium - Low	dB(A)	52 - 48 - 40
Unit	Height x Width x Depth	mm	150 x 990 x 450
	Weight	kg	14
Panel	Type	RBC-	UY32P-E
	Height x Width x Depth	mm	30 x 1220 x 530
	Weight	kg	4
Pipe Connection	Flare Connections (gas - liquid)	inch	3/8 - 1/4
	Drain Pipe Connection OD/ID	mm	32/25
Power Supply	Suggested Fuse Size	V/ph/Hz-A	220-240/1/50-5

### Accessories

<a href="#">RBC-AMTU31-E</a>	Standard Remote Controller - Full control including service functions
<a href="#">RBC-ASCU11-E</a>	Compact Remote Controller - Includes timer off, back light display, multilingual
<a href="#">RBC-AWSU52-E</a>	Premium Controller - Includes timer and back light display, multilingual (inc. Bluetooth)
<a href="#">RBC-MTSC1</a>	Mini Touch Screen Controller - with configurable icons for indoor units
<a href="#">RBC-MTSC2</a>	Mini Touch Screen Controller - with Schedule Timer, configurable icons for indoor units
<a href="#">TCB-EAPC1UYHP-E</a>	Air Purifier Kit - Set of Plasma Air Purifier, Dust Sensor, Air quality indicator and Wireless receiver
<a href="#">TCB-SIR41UYHP-E</a>	Occupancy Sensor - (Cannot match with wireless receiver kit)
<a href="#">RBC-AX33UYP-E</a>	Wireless receiver kit - (Cannot match with Occupancy sensor)

\*All [Accessories](#) / [Controls](#)

Compatible R410a outdoor condensers:

[Mini SMMS-e](#), [SMMS-u](#), [SHRM-e](#)

Compatible R32 outdoor condensers:

[Mini SMMS](#), [SHRM-a](#)

Related items:

- [Full specification](#)
- [BIM files](#)
- [CAD files](#)
- [Airflow/ fan curve](#)
- [Dimensional drawing](#)
- [Wiring diagram](#)
- [Noise curve data](#)
- [Installation manual](#)

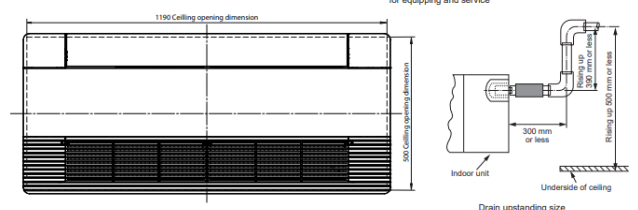
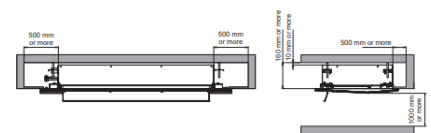

## VRF 1-WAY SLIM CASSETTE: MMU - UP0051YHP-E

- Advanced filtration available as an option.
- Ultra thin chassis (H x W x D) 150 x 990 x 450mm.
- Low noise level that can operate down to 25dB(A).
- Smart operation with Motion sensor available as an option.
- Ideal for false ceiling applications where the space for the unit is limited.



Hi - Res Image 



### Performance Data

Capacity Code		HP	0.6
Nominal	Cooling Capacity	kW	1.7
	Heating Capacity	kW	1.9
UK	Cooling Total/Sensible	kW	1.5/1.4
	Heating	kW	1.3
Electrical	Power Input	kW	0.015
	Run Current	Amps	0.15
	Start Current	Amps	0.40

### Indoor Data

Airflow	High - Medium - Low	l/s	133 - 102 - 75
	High - Medium - Low	m3/h	480 - 370 - 270
Sound	Pressure High - Medium - Low	dB(A)	37 - 33 - 25
	Power High - Medium - Low	dB(A)	52 - 48 - 40
Unit	Height x Width x Depth	mm	150 x 990 x 450
	Weight	kg	14
Panel	Type	RBC-	UY32P-E
	Height x Width x Depth	mm	30 x 1220 x 530
	Weight	kg	4
Pipe Connection	Flare Connections (gas - liquid)	inch	3/8 - 1/4
	Drain Pipe Connection OD/ID	mm	32/25
Power Supply	Suggested Fuse Size	V/ph/Hz-A	220-240/1/50-5

### Accessories

<a href="#">RBC-AMTU31-E</a>	Standard Remote Controller - Full control including service functions
<a href="#">RBC-ASCU11-E</a>	Compact Remote Controller - Includes timer off, back light display, multilingual
<a href="#">RBC-AWSU52-E</a>	Premium Controller - Includes timer and back light display, multilingual (inc. Bluetooth)
<a href="#">RBC-MTSC1</a>	Mini Touch Screen Controller - with configurable icons for indoor units
<a href="#">RBC-MTSC2</a>	Mini Touch Screen Controller - with Schedule Timer, configurable icons for indoor units
<a href="#">TCB-EAPC1UYHP-E</a>	Air Purifier Kit - Set of Plasma Air Purifier, Dust Sensor, Air quality indicator and Wireless receiver
<a href="#">TCB-SIR41UYHP-E</a>	Occupancy Sensor - (Cannot match with wireless receiver kit)
<a href="#">RBC-AX33UYHP-E</a>	Wireless receiver kit - (Cannot match with Occupancy sensor)

\*All [Accessories](#) / [Controls](#)

Compatible R410a outdoor condensers:

**[Mini SMMS-e](#), [SMMS-u](#), [SHRM-e](#)**

Compatible R32 outdoor condensers:

**[Mini SMMS](#), [SHRM-a](#)**

Related items:

- [Full specification](#)
- [BIM files](#)
- [CAD files](#)
- [Airflow/ fan curve](#)
- [Dimensional drawing](#)
- [Wiring diagram](#)
- [Noise curve data](#)
- [Installation manual](#)

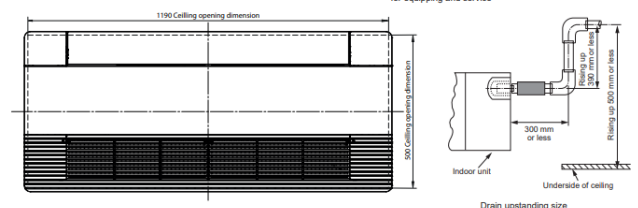
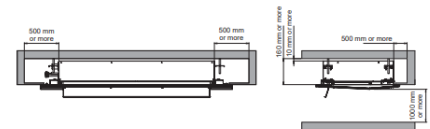

## VRF 1-WAY SLIM CASSETTE: MMU - UP0071YHP-E

- Advanced filtration available as an option.
- Ultra thin chassis (H x W x D) 150 x 990 x 450mm.
- Low noise level that can operate down to 25dB(A).
- Smart operation with Motion sensor available as an option.
- Ideal for false ceiling applications where the space for the unit is limited.



Hi - Res Image 



### Performance Data

Capacity Code		HP	0.8
Nominal	Cooling Capacity	kW	2.2
	Heating Capacity	kW	2.5
UK	Cooling Total/Sensible	kW	2.0/1.6
	Heating	kW	1.7
Electrical	Power Input	kW	0.017
	Run Current	Amps	0.18
	Start Current	Amps	0.40

### Indoor Data

Airflow	High - Medium - Low	l/s	150 - 133 - 117
	High - Medium - Low	m3/h	500 - 390 - 270
Sound	Pressure High - Medium - Low	dB(A)	38 - 34 - 25
	Power High - Medium - Low	dB(A)	53 - 49 - 40
Unit	Height x Width x Depth	mm	150 x 990 x 450
	Weight	kg	14
Panel	Type	RBC-	UY32P-E
	Height x Width x Depth	mm	30 x 1220 x 530
	Weight	kg	4
Pipe Connection	Flare Connections (gas - liquid)	inch	3/8 - 1/4
	Drain Pipe Connection OD/ID	mm	32/25
Power Supply	Suggested Fuse Size	V/ph/Hz-A	220-240/1/50-5

### Accessories

<a href="#">RBC-AMTU31-E</a>	Standard Remote Controller - Full control including service functions
<a href="#">RBC-ASCU11-E</a>	Compact Remote Controller - Includes timer off, back light display, multilingual
<a href="#">RBC-AWSU52-E</a>	Premium Controller - Includes timer and back light display, multilingual (inc. Bluetooth)
<a href="#">RBC-MTSC1</a>	Mini Touch Screen Controller - with configurable icons for indoor units
<a href="#">RBC-MTSC2</a>	Mini Touch Screen Controller - with Schedule Timer, configurable icons for indoor units
<a href="#">TCB-EAPC1UYHP-E</a>	Air Purifier Kit - Set of Plasma Air Purifier, Dust Sensor, Air quality indicator and Wireless receiver
<a href="#">TCB-SIR41UYHP-E</a>	Occupancy Sensor - (Cannot match with wireless receiver kit)
<a href="#">RBC-AX33UYP-E</a>	Wireless receiver kit - (Cannot match with Occupancy sensor)

\*All [Accessories](#) / [Controls](#)

Compatible R410a outdoor condensers:

**[Mini SMMS-e](#), [SMMS-u](#), [SHRM-e](#)**

Compatible R32 outdoor condensers:

**[Mini SMMS](#), [SHRM-a](#)**

Related items:

- [Full specification](#)
- [BIM files](#)
- [CAD files](#)
- [Airflow/ fan curve](#)
- [Dimensional drawing](#)
- [Wiring diagram](#)
- [Noise curve data](#)
- [Installation manual](#)

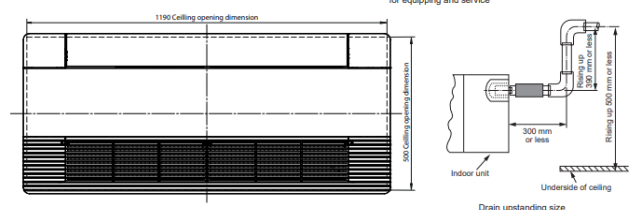
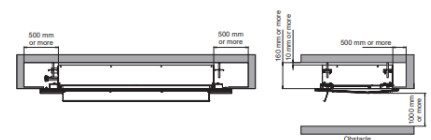

## VRF 1-WAY SLIM CASSETTE: MMU - UP0091YHP-E

- Advanced filtration available as an option.
- Ultra thin chassis (H x W x D) 150 x 990 x 450mm.
- Low noise level that can operate down to 26dB(A).
- Smart operation with Motion sensor available as an option.
- Ideal for false ceiling applications where the space for the unit is limited.



Hi - Res Image 



### Performance Data

Capacity Code		HP	1.0
Nominal	Cooling Capacity	kW	2.8
	Heating Capacity	kW	3.2
UK	Cooling Total/Sensible	kW	2.5/1.9
	Heating	kW	2.2
Electrical	Power Input	kW	0.018
	Run Current	Amps	0.19
	Start Current	Amps	0.40

### Indoor Data

Airflow	High - Medium - Low	l/s	150 - 133 - 117
	High - Medium - Low	m3/h	520 - 410 - 290
Sound	Pressure High - Medium - Low	dB(A)	39 - 35 - 26
	Power High - Medium - Low	dB(A)	54 - 50 - 41
Unit	Height x Width x Depth	mm	150 x 990 x 450
	Weight	kg	14
Panel	Type	RBC-	UY32P-E
	Height x Width x Depth	mm	30 x 1220 x 530
	Weight	kg	4
Pipe Connection	Flare Connections (gas - liquid)	inch	3/8 - 1/4
	Drain Pipe Connection OD/ID	mm	32/25
Power Supply	Suggested Fuse Size	V/ph/Hz-A	220-240/1/50-5

### Accessories

<a href="#">RBC-AMTU31-E</a>	Standard Remote Controller - Full control including service functions
<a href="#">RBC-ASCU11-E</a>	Compact Remote Controller - Includes timer off, back light display, multilingual
<a href="#">RBC-AWSU52-E</a>	Premium Controller - Includes timer and back light display, multilingual (inc. Bluetooth)
<a href="#">RBC-MTSC1</a>	Mini Touch Screen Controller - with configurable icons for indoor units
<a href="#">RBC-MTSC2</a>	Mini Touch Screen Controller - with Schedule Timer, configurable icons for indoor units
<a href="#">TCB-EAPC1UYHP-E</a>	Air Purifier Kit - Set of Plasma Air Purifier, Dust Sensor, Air quality indicator and Wireless receiver
<a href="#">TCB-SIR41UYHP-E</a>	Occupancy Sensor - (Cannot match with wireless receiver kit)
<a href="#">RBC-AX33UYHP-E</a>	Wireless receiver kit - (Cannot match with Occupancy sensor)

\*All [Accessories](#) / [Controls](#)

Compatible R410a outdoor condensers:

**[Mini SMMS-e](#), [SMMS-u](#), [SHRM-e](#)**

Compatible R32 outdoor condensers:

**[Mini SMMS](#), [SHRM-a](#)**

Related items:

- [Full specification](#)
- [BIM files](#)
- [CAD files](#)
- [Airflow/ fan curve](#)
- [Dimensional drawing](#)
- [Wiring diagram](#)
- [Noise curve data](#)
- [Installation manual](#)

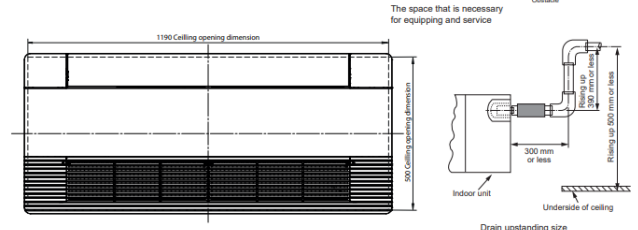
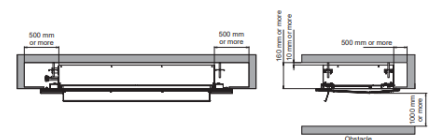

## VRF 1-WAY SLIM CASSETTE: MMU - UP0121YHP-E

- Advanced filtration available as an option.
- Ultra thin chassis (H x W x D) 150 x 990 x 450mm.
- Low noise level that can operate down to 26dB(A).
- Smart operation with Motion sensor available as an option.
- Ideal for false ceiling applications where the space for the unit is limited.



Hi - Res Image



### Performance Data

Capacity Code		HP	1.3
Nominal	Cooling Capacity	kW	3.6
	Heating Capacity	kW	4.0
UK	Cooling Total/Sensible	kW	3.3/2.4
	Heating	kW	2.7
Electrical	Power Input	kW	0.018
	Run Current	Amps	0.20
	Start Current	Amps	0.40

### Indoor Data

Airflow	High - Medium - Low	l/s	150 - 133 - 117
	High - Medium - Low	m3/h	540 - 420 - 290
Sound	Pressure High - Medium - Low	dB(A)	40 - 36 - 26
	Power High - Medium - Low	dB(A)	55 - 51 - 41
Unit	Height x Width x Depth	mm	150 x 990 x 450
	Weight	kg	14
Panel	Type	RBC-	UY32P-E
	Height x Width x Depth	mm	30 x 1220 x 530
	Weight	kg	4
Pipe Connection	Flare Connections (gas - liquid)	inch	3/8 - 1/4
	Drain Pipe Connection OD/ID	mm	32/25
Power Supply	Suggested Fuse Size	V/ph/Hz-A	220-240/1/50-5

### Accessories

<a href="#">RBC-AMTU31-E</a>	Standard Remote Controller - Full control including service functions
<a href="#">RBC-ASCU11-E</a>	Compact Remote Controller - Includes timer off, back light display, multilingual
<a href="#">RBC-AWSU52-E</a>	Premium Controller - Includes timer and back light display, multilingual (inc. Bluetooth)
<a href="#">RBC-MTSC1</a>	Mini Touch Screen Controller - with configurable icons for indoor units
<a href="#">RBC-MTSC2</a>	Mini Touch Screen Controller - with Schedule Timer, configurable icons for indoor units
<a href="#">TCB-EAPC1UYHP-E</a>	Air Purifier Kit - Set of Plasma Air Purifier, Dust Sensor, Air quality indicator and Wireless receiver
<a href="#">TCB-SIR41UYHP-E</a>	Occupancy Sensor - (Cannot match with wireless receiver kit)
<a href="#">RBC-AX33UYP-E</a>	Wireless receiver kit - (Cannot match with Occupancy sensor)

\*All [Accessories](#) / [Controls](#)

Compatible R410a outdoor condensers:

**[Mini SMMS-e](#), [SMMS-u](#), [SHRM-e](#)**

Compatible R32 outdoor condensers:

**[Mini SMMS](#), [SHRM-a](#)**

Related items:

- [Full specification](#)
- [BIM files](#)
- [CAD files](#)
- [Airflow/ fan curve](#)
- [Dimensional drawing](#)
- [Wiring diagram](#)
- [Noise curve data](#)
- [Installation manual](#)

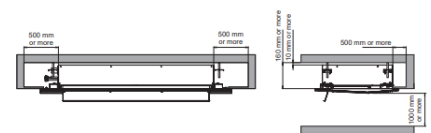

The space that is necessary for equipping and service

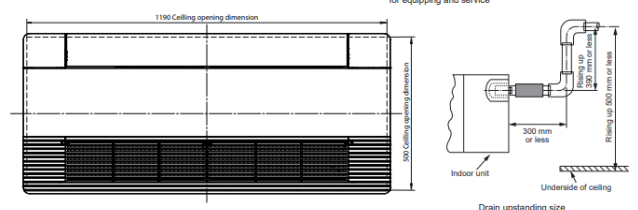

## VRF 1-WAY SLIM CASSETTE: MMU - UP0151YHP-E

- Advanced filtration available as an option.
- Ultra thin chassis (H x W x D) 150 x 1180 x 450mm.
- Low noise level that can operate down to 33dB(A).
- Smart operation with Motion sensor available as an option.
- Ideal for false ceiling applications where the space for the unit is limited.



Hi - Res Image 



### Performance Data

Capacity Code		HP	1.7
Nominal	Cooling Capacity	kW	4.5
	Heating Capacity	kW	5.0
UK	Cooling Total/Sensible	kW	4.1/2.9
	Heating	kW	3.4
Electrical	Power Input	kW	0.025
	Run Current	Amps	0.24
	Start Current	Amps	0.28

### Indoor Data

Airflow	High - Medium - Low	l/s	208 - 175 - 139
	High - Medium - Low	m3/h	750 - 630 - 500
Sound	Pressure High - Medium - Low	dB(A)	39 - 36 - 33
	Power High - Medium - Low	dB(A)	54 - 51 - 48
Unit	Height x Width x Depth	mm	150 x 1180 x 450
	Weight	kg	15
Panel	Type	RBC-	UY42P-E
	Height x Width x Depth	mm	30 x 1410 x 530
	Weight	kg	5
Pipe Connection	Flare Connections (gas - liquid)	inch	1/2 - 1/4
	Drain Pipe Connection OD/ID	mm	32/25
Power Supply	Suggested Fuse Size	V/ph/Hz-A	220-240/1/50-5

### Accessories

<a href="#">RBC-AMTU31-E</a>	Standard Remote Controller - Full control including service functions
<a href="#">RBC-ASCU11-E</a>	Compact Remote Controller - Includes timer off, back light display, multilingual
<a href="#">RBC-AWSU52-E</a>	Premium Controller - Includes timer and back light display, multilingual (inc. Bluetooth)
<a href="#">RBC-MTSC1</a>	Mini Touch Screen Controller - with configurable icons for indoor units
<a href="#">RBC-MTSC2</a>	Mini Touch Screen Controller - with Schedule Timer, configurable icons for indoor units
<a href="#">TCB-EAPC1UYHP-E</a>	Air Purifier Kit - Set of Plasma Air Purifier, Dust Sensor, Air quality indicator and Wireless receiver
<a href="#">TCB-SIR41UYHP-E</a>	Occupancy Sensor - (Cannot match with wireless receiver kit)
<a href="#">RBC-AX33UYP-E</a>	Wireless receiver kit - (Cannot match with Occupancy sensor)

\*All [Accessories / Controls](#)

Compatible R410a outdoor condensers:

**[Mini SMMS-e](#), [SMMS-u](#), [SHRM-e](#)**

Compatible R32 outdoor condensers:

**[Mini SMMS](#), [SHRM-a](#)**

Related items:

- [Full specification](#)
- [BIM files](#)
- [CAD files](#)
- [Airflow/ fan curve](#)
- [Dimensional drawing](#)
- [Wiring diagram](#)
- [Noise curve data](#)
- [Installation manual](#)

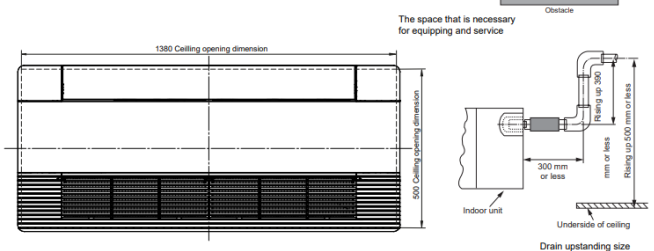
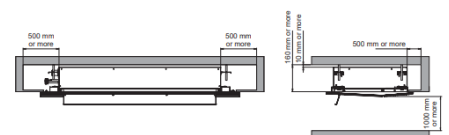



## VRF 1-WAY SLIM CASSETTE: MMU - UP0181YHP-E

- Advanced filtration available as an option.
- Ultra thin chassis (H x W x D) 150 x 1180 x 450mm.
- Low noise level that can operate down to 33dB(A).
- Smart operation with Motion sensor available as an option.
- Ideal for false ceiling applications where the space for the unit is limited.



Hi - Res Image



### Performance Data

Capacity Code		HP	2.0
Nominal	Cooling Capacity	kW	5.6
	Heating Capacity	kW	6.3
UK	Cooling Total/Sensible	kW	5.1/3.7
	Heating	kW	4.3
Electrical	Power Input	kW	0.027
	Run Current	Amps	0.26
	Start Current	Amps	0.30

### Indoor Data

Airflow	High - Medium - Low	l/s	222 - 181 - 139
	High - Medium - Low	m <sup>3</sup> /h	800 - 650 - 500
Sound	Pressure High - Medium - Low	dB(A)	40 - 37 - 33
	Power High - Medium - Low	dB(A)	55 - 52 - 48
Unit	Height x Width x Depth	mm	150 x 1180 x 450
	Weight	kg	15
Panel	Type	RBC-	UY42P-E
	Height x Width x Depth	mm	30 x 1410 x 530
	Weight	kg	5
Pipe Connection	Flare Connections (gas - liquid)	inch	1/2 - 1/4
	Drain Pipe Connection OD/ID	mm	32/25
Power Supply	Suggested Fuse Size	V/ph/Hz-A	220-240/1/50-5

### Accessories

<a href="#">RBC-AMTU31-E</a>	Standard Remote Controller - Full control including service functions
<a href="#">RBC-ASCU11-E</a>	Compact Remote Controller - Includes timer off, back light display, multilingual
<a href="#">RBC-AWSU52-E</a>	Premium Controller - Includes timer and back light display, multilingual (inc. Bluetooth)
<a href="#">RBC-MTSC1</a>	Mini Touch Screen Controller - with configurable icons for indoor units
<a href="#">RBC-MTSC2</a>	Mini Touch Screen Controller - with Schedule Timer, configurable icons for indoor units
<a href="#">TCB-EAPC1UYHP-E</a>	Air Purifier Kit - Set of Plasma Air Purifier, Dust Sensor, Air quality indicator and Wireless receiver
<a href="#">TCB-SIR41UYHP-E</a>	Occupancy Sensor - (Cannot match with wireless receiver kit)
<a href="#">RBC-AX33UYP-E</a>	Wireless receiver kit - (Cannot match with Occupancy sensor)

\*All [Accessories](#) / [Controls](#)

Compatible R410a outdoor condensers:

**[Mini SMMS-e](#), [SMMS-u](#), [SHRM-e](#)**

Compatible R32 outdoor condensers:

**[Mini SMMS](#), [SHRM-a](#)**

Related items:

- [Full specification](#)
- [BIM files](#)
- [CAD files](#)
- [Airflow/ fan curve](#)
- [Dimensional drawing](#)
- [Wiring diagram](#)
- [Noise curve data](#)
- [Installation manual](#)

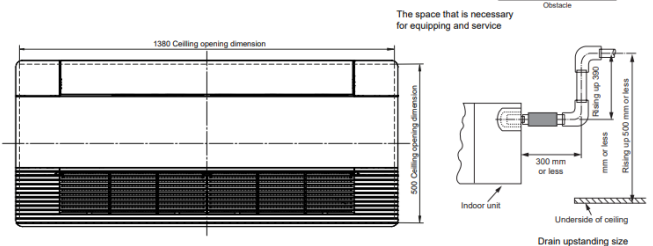
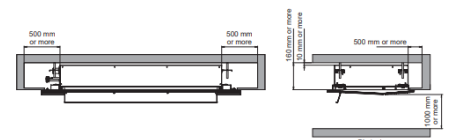

## VRF 1-WAY SLIM CASSETTE: MMU - UP0241YHP-E

- Advanced filtration available as an option.
- Ultra thin chassis (H x W x D) 150 x 1180 x 450mm.
- Low noise level that can operate down to 37dB(A).
- Smart operation with Motion sensor available as an option.
- Ideal for false ceiling applications where the space for the unit is limited.



Hi - Res Image 



### Performance Data

Capacity Code		HP	2.5
Nominal	Cooling Capacity	kW	7.1
	Heating Capacity	kW	8.0
UK	Cooling Total/Sensible	kW	6.4/4.6
	Heating	kW	5.4
Electrical	Power Input	kW	0.042
	Run Current	Amps	0.34
	Start Current	Amps	0.38

### Indoor Data

Airflow	High - Medium - Low	l/s	261 - 211 - 167
	High - Medium - Low	m3/h	940 - 760 - 600
Sound	Pressure High - Medium - Low	dB(A)	46 - 42 - 37
	Power High - Medium - Low	dB(A)	61 - 57 - 52
Unit	Height x Width x Depth	mm	150 x 1180 x 450
	Weight	kg	16
	Type	RBC-	UY42P-E
Panel	Height x Width x Depth	mm	30 x 1410 x 530
	Weight	kg	5
	Flare Connections (gas - liquid)	inch	5/8 - 3/8
Pipe Connection	Drain Pipe Connection OD/ID	mm	32/25
	Power Supply	Suggested Fuse Size	V/ph/Hz-A

### Accessories

<a href="#">RBC-AMTU31-E</a>	Standard Remote Controller - Full control including service functions
<a href="#">RBC-ASCU11-E</a>	Compact Remote Controller - Includes timer off, back light display, multilingual
<a href="#">RBC-AWSU52-E</a>	Premium Controller - Includes timer and back light display, multilingual (inc. Bluetooth)
<a href="#">RBC-MTSC1</a>	Mini Touch Screen Controller - with configurable icons for indoor units
<a href="#">RBC-MTSC2</a>	Mini Touch Screen Controller - with Schedule Timer, configurable icons for indoor units
<a href="#">TCB-EAPC1UYHP-E</a>	Air Purifier Kit - Set of Plasma Air Purifier, Dust Sensor, Air quality indicator and Wireless receiver
<a href="#">TCB-SIR41UYHP-E</a>	Occupancy Sensor - (Cannot match with wireless receiver kit)
<a href="#">RBC-AX33UY-P-E</a>	Wireless receiver kit - (Cannot match with Occupancy sensor)

\*All [Accessories / Controls](#)

Compatible R410a outdoor condensers:

**[Mini SMMS-e](#), [SMMS-u](#), [SHRM-e](#)**

Compatible R32 outdoor condensers:

**[Mini SMMS](#), [SHRM-a](#)**

Related items:

- [Full specification](#)
- [BIM files](#)
- [CAD files](#)
- [Airflow/ fan curve](#)
- [Dimensional drawing](#)
- [Wiring diagram](#)
- [Noise curve data](#)
- [Installation manual](#)

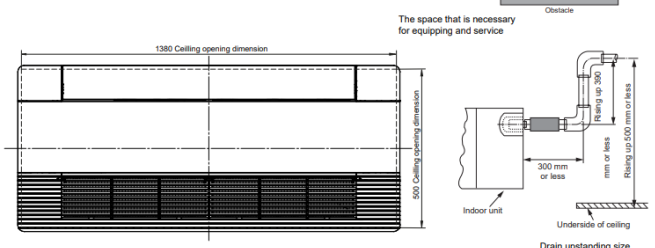
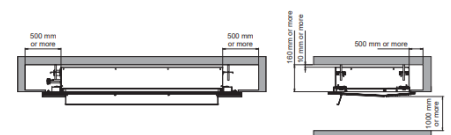

## VRF 1-WAY SLIM CASSETTE: MMU - UP0271YHP-E

- Advanced filtration available as an option.
- Ultra thin chassis (H x W x D) 150 x 1180 x 450mm.
- Low noise level that can operate down to 41dB(A).
- Smart operation with Motion sensor available as an option.
- Ideal for false ceiling applications where the space for the unit is limited.



Hi - Res Image 



### Performance Data

Capacity Code		HP	3.0
Nominal	Cooling Capacity	kW	8.0
	Heating Capacity	kW	9.0
UK	Cooling Total/Sensible	kW	7.3/5.0
	Heating	kW	9.0
Electrical	Power Input	kW	0.050
	Run Current	Amps	0.41
	Start Current	Amps	0.45

### Indoor Data

Airflow	High - Medium - Low	l/s	278 - 239 - 200
	High - Medium - Low	m3/h	1000 - 860 - 720
Sound	Pressure High - Medium - Low	dB(A)	47 - 44 - 41
	Power High - Medium - Low	dB(A)	62 - 59 - 56
Unit	Height x Width x Depth	mm	150 x 1180 x 450
	Weight	kg	16
Panel	Type	RBC-	UY42P-E
	Height x Width x Depth	mm	30 x 1410 x 530
	Weight	kg	5
Pipe Connection	Flare Connections (gas - liquid)	inch	5/8 - 3/8
	Drain Pipe Connection OD/ID	mm	32/25
Power Supply	Suggested Fuse Size	V/ph/Hz-A	220-240/1/50-5

### Accessories

<a href="#">RBC-AMTU31-E</a>	Standard Remote Controller - Full control including service functions
<a href="#">RBC-ASCU11-E</a>	Compact Remote Controller - Includes timer off, back light display, multilingual
<a href="#">RBC-AWSU52-E</a>	Premium Controller - Includes timer and back light display, multilingual (inc. Bluetooth)
<a href="#">RBC-MTSC1</a>	Mini Touch Screen Controller - with configurable icons for indoor units
<a href="#">RBC-MTSC2</a>	Mini Touch Screen Controller - with Schedule Timer, configurable icons for indoor units
<a href="#">TCB-EAPC1UYHP-E</a>	Air Purifier Kit - Set of Plasma Air Purifier, Dust Sensor, Air quality indicator and Wireless receiver
<a href="#">TCB-SIR41UYHP-E</a>	Occupancy Sensor - (Cannot match with wireless receiver kit)
<a href="#">RBC-AX33UYP-E</a>	Wireless receiver kit - (Cannot match with Occupancy sensor)

\*All [Accessories](#) / [Controls](#)

Compatible R410a outdoor condensers:

**[Mini SMMS-e](#), [SMMS-u](#), [SHRM-e](#)**

Compatible R32 outdoor condensers:

**[Mini SMMS](#), [SHRM-a](#)**

Related items:

- [Full specification](#)
- [BIM files](#)
- [CAD files](#)
- [Airflow/ fan curve](#)
- [Dimensional drawing](#)
- [Wiring diagram](#)
- [Noise curve data](#)
- [Installation manual](#)

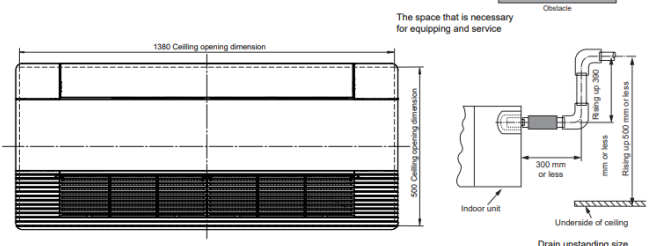
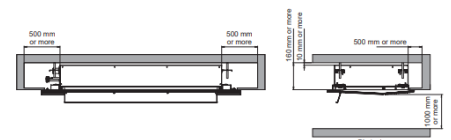

# 1-Way Standard Cassette



## VRF 1-WAY STANDARD CASSETTE: MMU - UP0151SH-E

- Quiet operation ONLY 33dB (A).
- Flexible control options, hard wired or infra-red.
- Suitable for small areas, such as hotels, offices and reception rooms.
- Water condensate drain pump lifts condensate water up to 350mm.
- Optional front air discharge duct, allowing the air to be blown horizontally into the room.



Hi - Res Image 



### Performance Data

Capacity Code		HP	1.7
Nominal	Cooling Capacity	kW	4.5
	Heating Capacity	kW	5.0
UK	Cooling Total/Sensible	kW	4.1/3.0
	Heating	kW	3.4
	Power Input	kW	0.042
Electrical	Run Current	Amps	0.34
	Start Current	Amps	0.51

### Indoor Data

Airflow	High - Medium - Low	l/s	208 - 192 - 175
	High - Medium - Low	m <sup>3</sup> /h	750 - 690 - 630
Sound	Pressure High - Medium - Low	dB(A)	37 - 35 - 32
	Power High - Medium - Low	dB(A)	52 - 50 - 47
Unit	Height x Width x Depth	mm	200 x 1000 x 710
	Weight	kg	21
Panel	Type	RBC-	US21PGE
	Height x Width x Depth	mm	20 x 1230 x 800
	Weight	kg	5.5
Pipe Connection	Flare Connections (gas - liquid)	inch	1/2 - 1/4
	Drain Pipe Connection OD/ID	mm	32/25
Power Supply	Suggested Fuse Size	V/ph/Hz-A	220-240/1/50-5

### Accessories

<a href="#">RBC-AMTU31-E</a>	Standard Remote Controller - Full control including service functions
<a href="#">RBC-ASCU11-E</a>	Compact Remote Controller - Includes timer off, back light display, multilingual
<a href="#">RBC-AWSU52-E</a>	Premium Controller - Includes timer and back light display, multilingual (inc. Bluetooth)
<a href="#">RBC-MTSC1</a>	Mini Touch Screen Controller - with configurable icons for indoor units
<a href="#">RBC-MTSC2</a>	Mini Touch Screen Controller - with Schedule Timer, configurable icons for indoor units
<a href="#">TCB-FF101URE2</a>	Auxiliary fresh air flange - For easy fresh air intake using knock out hole of indoor unit.
<a href="#">TCB-BUS21HW-E</a>	Front air discharge unit - Allowing air to be blown horizontally into the room.

#### \*All [Accessories](#) / [Controls](#)

Compatible R410a outdoor condensers:

[Mini SMMS-e](#), [SMMS-u](#), [SHRM-e](#)

Compatible R32 outdoor condensers:

[Mini SMMS](#), [SHRM-a](#)

Related items:

- [Full specification](#)
- [BIM files](#)
- [Airflow/ fan curve](#)
- [Dimensional drawing](#)
- [Wiring diagram](#)
- [Noise curve data](#)
- [Installation manual](#)

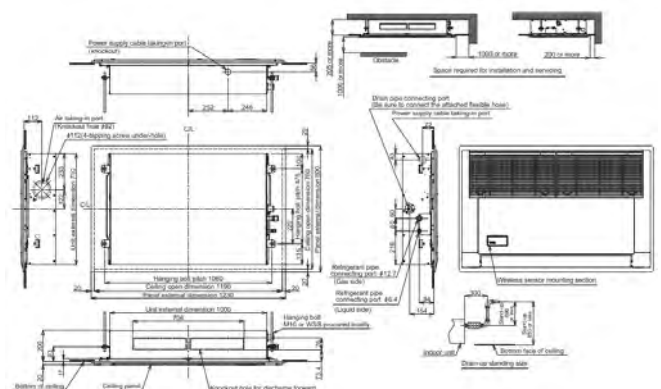

## VRF 1-WAY STANDARD CASSETTE: MMU - UP0181SH-E

- Quiet operation ONLY 34dB (A).
- Flexible control options, hard wired or infra-red.
- Suitable for small areas, such as hotels, offices and reception rooms.
- Water condensate drain pump lifts condensate water up to 350mm.
- Optional front air discharge duct, allowing the air to be blown horizontally into the room.



Hi - Res Image 



### Performance Data

Capacity Code		HP	2.0
Nominal	Cooling Capacity	kW	5.6
	Heating Capacity	kW	6.3
UK	Cooling Total/Sensible	kW	5.1/3.7
	Heating	kW	4.3
Electrical	Power Input	kW	0.046
	Run Current	Amps	0.37
	Start Current	Amps	0.54

### Indoor Data

Airflow	High - Medium - Low	l/s	217 - 200 - 183
	High - Medium - Low	m3/h	780 - 720 - 660
Sound	Pressure High - Medium - Low	dB(A)	38 - 36 - 34
	Power High - Medium - Low	dB(A)	53 - 51 - 49
Unit	Height x Width x Depth	mm	200 x 1000 x 710
	Weight	kg	21
Panel	Type	RBC-	US21PGE
	Height x Width x Depth	mm	20 x 1230 x 800
	Weight	kg	5.5
Pipe Connection	Flare Connections (gas - liquid)	inch	1/2 - 1/4
	Drain Pipe Connection OD/ID	mm	32/25
Power Supply	Suggested Fuse Size	V/ph/Hz-A	220-240/1/50-5

### Accessories

<a href="#">RBC-AMTU31-E</a>	Standard Remote Controller - Full control including service functions
<a href="#">RBC-ASCU11-E</a>	Compact Remote Controller - Includes timer off, back light display, multilingual
<a href="#">RBC-AWSU52-E</a>	Premium Controller - Includes timer and back light display, multilingual (inc. Bluetooth)
<a href="#">RBC-MTSC1</a>	Mini Touch Screen Controller - with configurable icons for indoor units
<a href="#">RBC-MTSC2</a>	Mini Touch Screen Controller - with Schedule Timer, configurable icons for indoor units
<a href="#">TCB-FF101URE2</a>	Auxiliary fresh air flange - For easy fresh air intake using knock out hole of indoor unit.
<a href="#">TCB-BUS21HW-E</a>	Front air discharge unit - Allowing air to be blown horizontally into the room.

\*All [Accessories](#) / [Controls](#)

Compatible R410a outdoor condensers:

[Mini SMMS-e](#), [SMMS-u](#), [SHRM-e](#)

Compatible R32 outdoor condensers:

[Mini SMMS](#), [SHRM-a](#)

Related items:

- [Full specification](#)
- [BIM files](#)
- [Airflow/ fan curve](#)
- [Dimensional drawing](#)
- [Wiring diagram](#)
- [Noise curve data](#)
- [Installation manual](#)

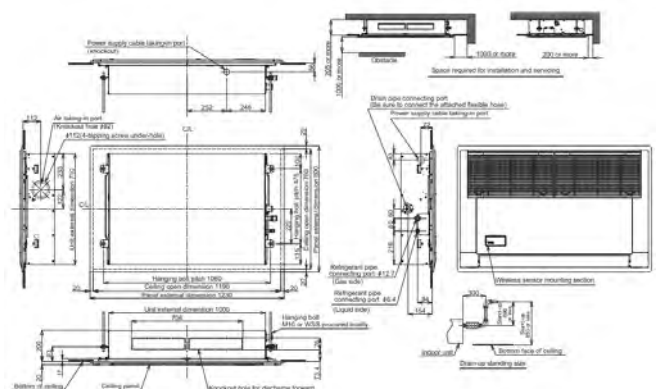

## VRF 1-WAY STANDARD CASSETTE: MMU - UP0241SH-E

- Quiet operation ONLY 37dB (A).
- Flexible control options, hard wired or infra-red.
- Suitable for small areas, such as hotels, offices and reception rooms.
- Water condensate drain pump lifts condensate water up to 350mm.
- Optional front air discharge duct, allowing the air to be blown horizontally into the room.



Hi - Res Image 



### Performance Data

Capacity Code		HP	2.5
Nominal	Cooling Capacity	kW	7.1
	Heating Capacity	kW	8.0
UK	Cooling Total/Sensible	kW	6.4/4.7
	Heating	kW	5.4
	Power Input	kW	0.075
Electrical	Run Current	Amps	0.62
	Start Current	Amps	0.80

### Indoor Data

Airflow	High - Medium - Low	l/s	317 - 267 - 225
	High - Medium - Low	m3/h	1140 - 960 - 810
Sound	Pressure High - Medium - Low	dB(A)	45 - 41 - 37
	Power High - Medium - Low	dB(A)	60 - 56 - 52
Unit	Height x Width x Depth	mm	200 x 1000 x 710
	Weight	kg	22
Panel	Type	RBC-	US21PGE
	Height x Width x Depth	mm	20 x 1230 x 800
	Weight	kg	5.5
Pipe Connection	Flare Connections (gas - liquid)	inch	1/2 - 3/8
	Drain Pipe Connection OD/ID	mm	32/25
Power Supply	Suggested Fuse Size	V/ph/Hz-A	220-240/1/50-5

### Accessories

<a href="#">RBC-AMTU31-E</a>	Standard Remote Controller - Full control including service functions
<a href="#">RBC-ASCU11-E</a>	Compact Remote Controller - Includes timer off, back light display, multilingual
<a href="#">RBC-AWSU52-E</a>	Premium Controller - Includes timer and back light display, multilingual (inc. Bluetooth)
<a href="#">RBC-MTSC1</a>	Mini Touch Screen Controller - with configurable icons for indoor units
<a href="#">RBC-MTSC2</a>	Mini Touch Screen Controller - with Schedule Timer, configurable icons for indoor units
<a href="#">TCB-FF101URE2</a>	Auxiliary fresh air flange - For easy fresh air intake using knock out hole of indoor unit.
<a href="#">TCB-BUS21HW-E</a>	Front air discharge unit - Allowing air to be blown horizontally into the room.

\*All [Accessories](#) / [Controls](#)

Compatible R410a outdoor condensers:

[Mini SMMS-e](#), [SMMS-u](#), [SHRM-e](#)

Compatible R32 outdoor condensers:

[Mini SMMS](#), [SHRM-a](#)

Related items:

- [Full specification](#)
- [BIM files](#)
- [Airflow/ fan curve](#)
- [Dimensional drawing](#)
- [Wiring diagram](#)
- [Noise curve data](#)
- [Installation manual](#)

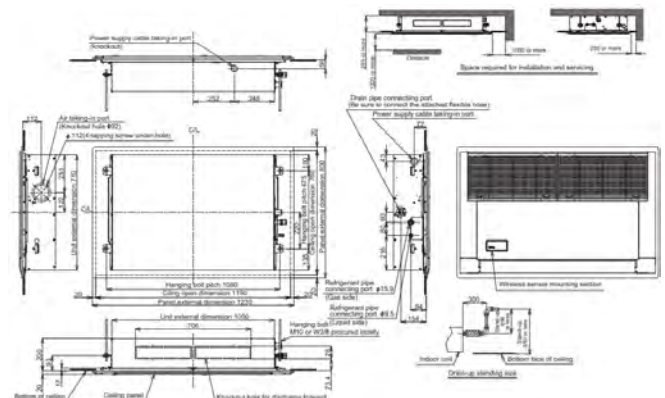

# 2-Way Cassette





## VRF 2-WAY CASSETTE: MMU - UP0071WH-E

- Compact dimensions (height 295mm).
- Minimal weight (19 kg) for units up to 4.5kw.
- Enhanced indoor air quality with standard long-life filters.
- Unique air flow control, provides a balanced flow of air in two opposite directions.
- The elegant white decorative panel allows the unit to be installed seamlessly into any room.



Hi - Res Image 



### Performance Data

Capacity Code		HP	0.8
Nominal	Cooling Capacity	kW	2.2
	Heating Capacity	kW	2.5
UK	Cooling Total/Sensible	kW	2.0/1.5
	Heating	kW	1.7
Electrical	Power Input	kW	0.024
	Run Current	Amps	0.22
	Start Current	Amps	0.32

### Indoor Data

Airflow	High - Medium - Low	l/s	155 - 138 - 125
	High - Medium - Low	m3/h	558 - 498 - 450
Sound	Pressure High - Medium - Low	dB(A)	34 - 32 - 30
	Power High - Medium - Low	dB(A)	49 - 47 - 45
Unit	Height x Width x Depth	mm	295 x 815 x 570
	Weight	kg	19
Panel	Type	RBC-	UW283PG(W)-E
	Height x Width x Depth	mm	20 x 1050 x 680
	Weight	kg	10
Pipe Connection	Flare Connections (gas - liquid)	inch	3/8 - 1/4
	Drain Pipe Connection OD/ID	mm	32/25
Power Supply	Suggested Fuse Size	V/ph/Hz-A	220-240/1/50-5

### Accessories

<a href="#">RBC-AMTU31-E</a>	Standard Remote Controller - Full control including service functions
<a href="#">RBC-ASCU11-E</a>	Compact Remote Controller - Includes timer off, back light display, multilingual
<a href="#">RBC-AWSU52-E</a>	Premium Controller - Includes timer and back light display, multilingual (inc. Bluetooth)
<a href="#">RBC-MTSC1</a>	Mini Touch Screen Controller - with configurable icons for indoor units
<a href="#">RBC-MTSC2</a>	Mini Touch Screen Controller - with Schedule Timer, configurable icons for indoor units
<a href="#">TCB-FF151US-E</a>	Auxiliary fresh air flange - For Fresh air intake by using the knock out hole of indoor unit
<a href="#">TBC-LF**3UW-E</a>	Super Long Life Filter - Dust collecting effect 50% (Weight method) - Use with TBC-FC**3UW-E
<a href="#">TBC-FC**3UW-E</a>	Filter chamber - Chamber for Super long life filter - Use with TBC-LF**3UW-E

\*All [Accessories](#) / [Controls](#)

Compatible R410a outdoor condensers:

[Mini SMMS-e](#), [SMMS-u](#), [SHRM-e](#)

Compatible R32 outdoor condensers:

[Mini SMMS](#), [SHRM-a](#)

Related items:

- [Full specification](#)
- [BIM files](#)
- [CAD files](#)
- [Airflow/ fan curve](#)
- [Dimensional drawing](#)
- [Wiring diagram](#)
- [Noise curve data](#)
- [Installation manual](#)

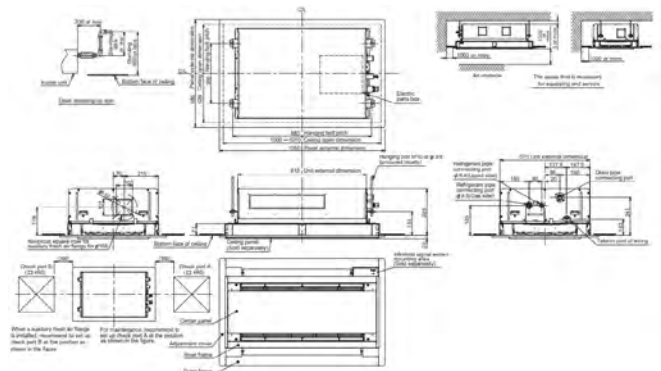

## VRF 2-WAY CASSETTE: MMU - UP0091WH-E

- Compact dimensions (height 295mm).
- Minimal weight (19 kg) for units up to 4.5kw.
- Enhanced indoor air quality with standard long-life filters.
- Unique air flow control, provides a balanced flow of air in two opposite directions.
- The elegant white decorative panel allows the unit to be installed seamlessly into any room.



Hi - Res Image 



### Performance Data

Capacity Code		HP	1.0
Nominal	Cooling Capacity	kW	2.8
	Heating Capacity	kW	3.2
UK	Cooling Total/Sensible	kW	2.5/1.9
	Heating	kW	2.2
	Power Input	kW	0.024
Electrical	Run Current	Amps	0.22
	Start Current	Amps	0.32

### Indoor Data

Airflow	High - Medium - Low	l/s	155 - 138 - 125
	High - Medium - Low	m3/h	558 - 498 - 450
Sound	Pressure High - Medium - Low	dB(A)	34 - 32 - 30
	Power High - Medium - Low	dB(A)	49 - 47 - 45
Unit	Height x Width x Depth	mm	295 x 815 x 570
	Weight	kg	19
Panel	Type	RBC-	UW283PG(W)-E
	Height x Width x Depth	mm	20 x 1050 x 680
	Weight	kg	10
Pipe Connection	Flare Connections (gas - liquid)	inch	3/8 - 1/4
	Drain Pipe Connection OD/ID	mm	32/25
Power Supply	Suggested Fuse Size	V/ph/Hz-A	220-240/1/50-5

### Accessories

<a href="#">RBC-AMTU31-E</a>	Standard Remote Controller - Full control including service functions
<a href="#">RBC-ASCU11-E</a>	Compact Remote Controller - Includes timer off, back light display, multilingual
<a href="#">RBC-AWSU52-E</a>	Premium Controller - Includes timer and back light display, multilingual (inc. Bluetooth)
<a href="#">RBC-MTSC1</a>	Mini Touch Screen Controller - with configurable icons for indoor units
<a href="#">RBC-MTSC2</a>	Mini Touch Screen Controller - with Schedule Timer, configurable icons for indoor units
<a href="#">TCB-FF151US-E</a>	Auxiliary fresh air flange - For Fresh air intake by using the knock out hole of indoor unit
<a href="#">TBC-LF**3UW-E</a>	Super Long Life Filter - Dust collecting effect 50% (Weight method) - Use with TBC-FC**3UW-E
<a href="#">TBC-FC**3UW-E</a>	Filter chamber - Chamber for Super long life filter - Use with TBC-LF**3UW-E

\*All [Accessories](#) / [Controls](#)

Compatible R410a outdoor condensers:

[Mini SMMS-e](#), [SMMS-u](#), [SHRM-e](#)

Compatible R32 outdoor condensers:

[Mini SMMS](#), [SHRM-a](#)

Related items:

- [Full specification](#)
- [BIM files](#)
- [CAD files](#)
- [Airflow/ fan curve](#)
- [Dimensional drawing](#)
- [Wiring diagram](#)
- [Noise curve data](#)
- [Installation manual](#)

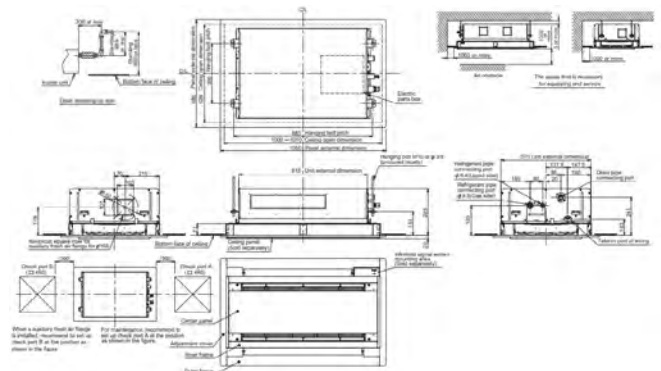

## VRF 2-WAY CASSETTE: MMU - UP0121WH-E

- Compact dimensions (height 295mm).
- Minimal weight (19 kg) for units up to 4.5kw.
- Enhanced indoor air quality with standard long-life filters.
- Unique air flow control, provides a balanced flow of air in two opposite directions.
- The elegant white decorative panel allows the unit to be installed seamlessly into any room.



Hi - Res Image 



### Performance Data

Capacity Code		HP	1.3
Nominal	Cooling Capacity	kW	3.6
	Heating Capacity	kW	4.0
UK	Cooling Total/Sensible	kW	3.3/2.4
	Heating	kW	2.7
Electrical	Power Input	kW	0.024
	Run Current	Amps	0.22
	Start Current	Amps	0.32

### Indoor Data

Airflow	High - Medium - Low	l/s	155 - 138 - 125
	High - Medium - Low	m3/h	558 - 498 - 450
Sound	Pressure High - Medium - Low	dB(A)	34 - 32 - 30
	Power High - Medium - Low	dB(A)	49 - 47 - 45
Unit	Height x Width x Depth	mm	295 x 815 x 570
	Weight	kg	19
Panel	Type	RBC-	UW283PG(W)-E
	Height x Width x Depth	mm	20 x 1050 x 680
	Weight	kg	10
Pipe Connection	Flare Connections (gas - liquid)	inch	3/8 - 1/4
	Drain Pipe Connection OD/ID	mm	32/25
Power Supply	Suggested Fuse Size	V/ph/Hz-A	220-240/1/50-5

### Accessories

<a href="#">RBC-AMTU31-E</a>	Standard Remote Controller - Full control including service functions
<a href="#">RBC-ASCU11-E</a>	Compact Remote Controller - Includes timer off, back light display, multilingual
<a href="#">RBC-AWSU52-E</a>	Premium Controller - Includes timer and back light display, multilingual (inc. Bluetooth)
<a href="#">RBC-MTSC1</a>	Mini Touch Screen Controller - with configurable icons for indoor units
<a href="#">RBC-MTSC2</a>	Mini Touch Screen Controller - with Schedule Timer, configurable icons for indoor units
<a href="#">TCB-FF151US-E</a>	Auxiliary fresh air flange - For Fresh air intake by using the knock out hole of indoor unit
<a href="#">TBC-LF**3UW-E</a>	Super Long Life Filter - Dust collecting effect 50% (Weight method) - Use with TBC-FC**3UW-E
<a href="#">TBC-FC**3UW-E</a>	Filter chamber - Chamber for Super long life filter - Use with TBC-LF**3UW-E

\*All [Accessories](#) / [Controls](#)

Compatible R410a outdoor condensers:

[Mini SMMS-e](#), [SMMS-u](#), [SHRM-e](#)

Compatible R32 outdoor condensers:

[Mini SMMS](#), [SHRM-a](#)

Related items:

- [Full specification](#)
- [BIM files](#)
- [CAD files](#)
- [Airflow/ fan curve](#)
- [Dimensional drawing](#)
- [Wiring diagram](#)
- [Noise curve data](#)
- [Installation manual](#)

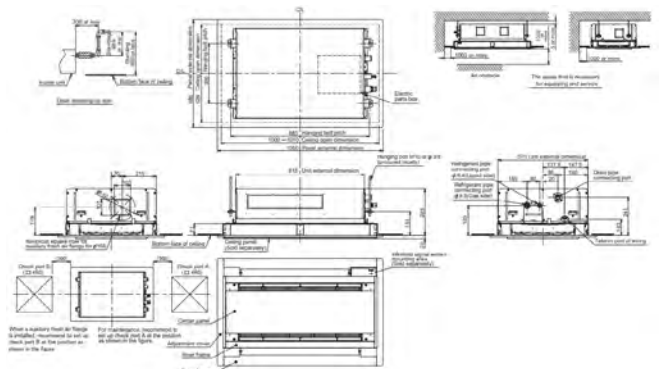

## VRF 2 WAY-CASSETTE: MMU - UP0151WH-E

- Compact dimensions (height 295mm).
- Minimal weight (19 kg) for units up to 4.5kw.
- Enhanced indoor air quality with standard long-life filters.
- Unique air flow control, provides a balanced flow of air in two opposite directions.
- The elegant white decorative panel allows the unit to be installed seamlessly into any room.



Hi - Res Image 



### Performance Data

Capacity Code		HP	1.7
Nominal	Cooling Capacity	kW	4.5
	Heating Capacity	kW	5.0
UK	Cooling Total/Sensible	kW	4.1/2.9
	Heating	kW	3.4
Electrical	Power Input	kW	0.026
	Run Current	Amps	0.22
	Start Current	Amps	0.35

### Indoor Data

Airflow	High - Medium - Low	l/s	167 - 148 - 125
	High - Medium - Low	m3/h	600 - 534 - 450
Sound	Pressure High - Medium - Low	dB(A)	35 - 33 - 30
	Power High - Medium - Low	dB(A)	50 - 48 - 45
Unit	Height x Width x Depth	mm	295 x 815 x 570
	Weight	kg	19
Panel	Type	RBC-	UW283PG(W)-E
	Height x Width x Depth	mm	20 x 1050 x 680
	Weight	kg	10
Pipe Connection	Flare Connections (gas - liquid)	inch	1/2 - 1/4
	Drain Pipe Connection OD/ID	mm	32/25
Power Supply	Suggested Fuse Size	V/ph/Hz-A	220-240/1/50-5

### Accessories

<a href="#">RBC-AMTU31-E</a>	Standard Remote Controller - Full control including service functions
<a href="#">RBC-ASCU11-E</a>	Compact Remote Controller - Includes timer off, back light display, multilingual
<a href="#">RBC-AWSU52-E</a>	Premium Controller - Includes timer and back light display, multilingual (inc. Bluetooth)
<a href="#">RBC-MTSC1</a>	Mini Touch Screen Controller - with configurable icons for indoor units
<a href="#">RBC-MTSC2</a>	Mini Touch Screen Controller - with Schedule Timer, configurable icons for indoor units
<a href="#">TCB-FF151US-E</a>	Auxiliary fresh air flange - For Fresh air intake by using the knock out hole of indoor unit
<a href="#">TBC-LF**3UW-E</a>	Super Long Life Filter - Dust collecting effect 50% (Weight method) - Use with TBC-FC**3UW-E
<a href="#">TBC-FC**3UW-E</a>	Filter chamber - Chamber for Super long life filter - Use with TBC-LF**3UW-E

\*All [Accessories](#) / [Controls](#)

Compatible R410a outdoor condensers:

[Mini SMMS-e](#), [SMMS-u](#), [SHRM-e](#)

Compatible R32 outdoor condensers:

[Mini SMMS](#), [SHRM-a](#)

Related items:

- [Full specification](#)
- [BIM files](#)
- [CAD files](#)
- [Airflow/ fan curve](#)
- [Dimensional drawing](#)
- [Wiring diagram](#)
- [Noise curve data](#)
- [Installation manual](#)

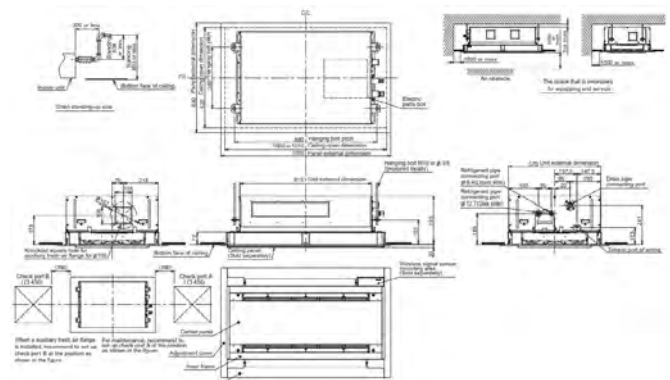

## VRF 2-WAY CASSETTE: MMU - UP0181WH-E

- Compact dimensions (height 345mm).
- Minimal weight (26 kg) for units up to 10kw.
- Enhanced indoor air quality with standard long-life filters.
- Unique air flow control, provides a balanced flow of air in two opposite directions.
- The elegant white decorative panel allows the unit to be installed seamlessly into any room.



Hi - Res Image 



### Performance Data

Capacity Code		HP	2.0
Nominal	Cooling Capacity	kW	5.6
	Heating Capacity	kW	6.3
UK	Cooling Total/Sensible	kW	5.1/3.7
	Heating	kW	4.3
Electrical	Power Input	kW	0.034
	Run Current	Amps	0.29
	Start Current	Amps	0.44

### Indoor Data

Airflow	High - Medium - Low	l/s	250 - 208 - 172
	High - Medium - Low	m3/h	900 - 750 - 618
Sound	Pressure High - Medium - Low	dB(A)	35 - 33 - 30
	Power High - Medium - Low	dB(A)	50 - 48 - 45
Unit	Height x Width x Depth	mm	345 x 1180 x 570
	Weight	kg	26
Panel	Type	RBC-	UW803PG(W)-E
	Height x Width x Depth	mm	20 x 1415 x 680
	Weight	kg	14
Pipe Connection	Flare Connections (gas - liquid)	inch	1/2 - 1/4
	Drain Pipe Connection OD/ID	mm	32/25
Power Supply	Suggested Fuse Size	V/ph/Hz-A	220-240/1/50-5

### Accessories

<a href="#">RBC-AMTU31-E</a>	Standard Remote Controller - Full control including service functions
<a href="#">RBC-ASCU11-E</a>	Compact Remote Controller - Includes timer off, back light display, multilingual
<a href="#">RBC-AWSU52-E</a>	Premium Controller - Includes timer and back light display, multilingual (inc. Bluetooth)
<a href="#">RBC-MTSC1</a>	Mini Touch Screen Controller - with configurable icons for indoor units
<a href="#">RBC-MTSC2</a>	Mini Touch Screen Controller - with Schedule Timer, configurable icons for indoor units
<a href="#">TCB-FF151US-E</a>	Auxiliary fresh air flange - For Fresh air intake by using the knock out hole of indoor unit
<a href="#">TBC-LF**3UW-E</a>	Super Long Life Filter - Dust collecting effect 50% (Weight method) - Use with TBC-FC**3UW-E
<a href="#">TBC-FC**3UW-E</a>	Filter chamber - Chamber for Super long life filter - Use with TBC-LF**3UW-E

\*All [Accessories](#) / [Controls](#)

Compatible R410a outdoor condensers:

[Mini SMMS-e](#), [SMMS-u](#), [SHRM-e](#)

Compatible R32 outdoor condensers:

[Mini SMMS](#), [SHRM-a](#)

Related items:

- [Full specification](#)
- [BIM files](#)
- [CAD files](#)
- [Airflow/ fan curve](#)
- [Dimensional drawing](#)
- [Wiring diagram](#)
- [Noise curve data](#)
- [Installation manual](#)

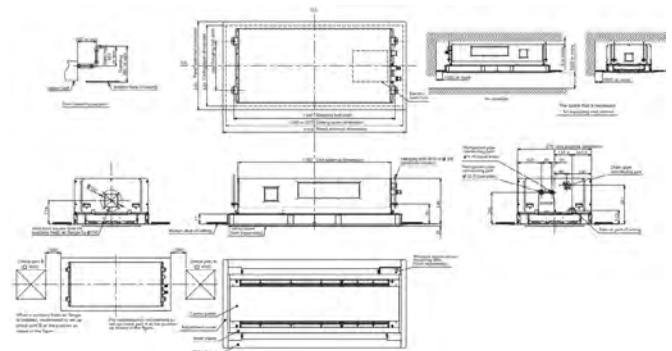

## VRF 2-WAY CASSETTE: MMU - UP0241WH-E

- Compact dimensions (height 345mm).
- Minimal weight (26 kg) for units up to 10kw.
- Enhanced indoor air quality with standard long-life filters.
- Unique air flow control, provides a balanced flow of air in two opposite directions.
- The elegant white decorative panel allows the unit to be installed seamlessly into any room.



Hi - Res Image 



### Performance Data

Capacity Code		HP	2.5
Nominal	Cooling Capacity	kW	7.1
	Heating Capacity	kW	8.0
UK	Cooling Total/Sensible	kW	6.4/4.6
	Heating	kW	5.4
Electrical	Power Input	kW	0.045
	Run Current	Amps	0.39
	Start Current	Amps	0.60

### Indoor Data

Airflow	High - Medium - Low	l/s	292 - 233 - 205
	High - Medium - Low	m3/h	1050 - 840 - 738
Sound	Pressure High - Medium - Low	dB(A)	38 - 35 - 33
	Power High - Medium - Low	dB(A)	53 - 50 - 48
Unit	Height x Width x Depth	mm	345 x 1180 x 570
	Weight	kg	26
Panel	Type	RBC-	UW803PG(W)-E
	Height x Width x Depth	mm	20 x 1415 x 680
	Weight	kg	14
Pipe Connection	Flare Connections (gas - liquid)	inch	5/8 - 3/8
	Drain Pipe Connection OD/ID	mm	32/25
Power Supply	Suggested Fuse Size	V/ph/Hz-A	220-240/1/50-5

### Accessories

<a href="#">RBC-AMTU31-E</a>	Standard Remote Controller - Full control including service functions
<a href="#">RBC-ASCU11-E</a>	Compact Remote Controller - Includes timer off, back light display, multilingual
<a href="#">RBC-AWSU52-E</a>	Premium Controller - Includes timer and back light display, multilingual (inc. Bluetooth)
<a href="#">RBC-MTSC1</a>	Mini Touch Screen Controller - with configurable icons for indoor units
<a href="#">RBC-MTSC2</a>	Mini Touch Screen Controller - with Schedule Timer, configurable icons for indoor units
<a href="#">TCB-FF151US-E</a>	Auxiliary fresh air flange - For Fresh air intake by using the knock out hole of indoor unit
<a href="#">TBC-LF**3UW-E</a>	Super Long Life Filter - Dust collecting effect 50% (Weight method) - Use with TBC-FC**3UW-E
<a href="#">TBC-FC**3UW-E</a>	Filter chamber - Chamber for Super long life filter - Use with TBC-LF**3UW-E

\*All [Accessories](#) / [Controls](#)

Compatible R410a outdoor condensers:

[Mini SMMS-e](#), [SMMS-u](#), [SHRM-e](#)

Compatible R32 outdoor condensers:

[Mini SMMS](#), [SHRM-a](#)

Related items:

- [Full specification](#)
- [BIM files](#)
- [CAD files](#)
- [Airflow/ fan curve](#)
- [Dimensional drawing](#)
- [Wiring diagram](#)
- [Noise curve data](#)
- [Installation manual](#)

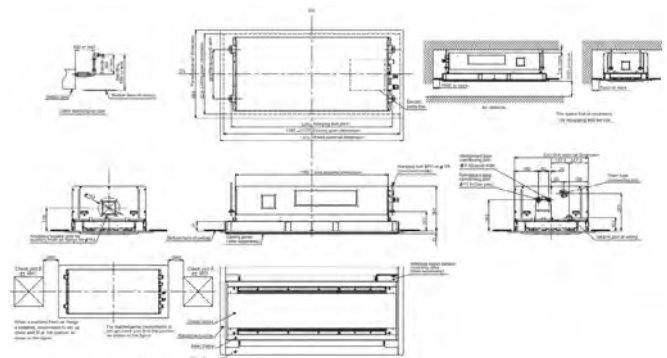

## VRF 2-WAY CASSETTE: MMU - UP0271WH-E

- Compact dimensions (height 345mm).
- Minimal weight (26 kg) for units up to 10kw.
- Enhanced indoor air quality with standard long-life filters.
- Unique air flow control, provides a balanced flow of air in two opposite directions.
- The elegant white decorative panel allows the unit to be installed seamlessly into any room.



Hi - Res Image 



### Performance Data

Capacity Code		HP	3.0
Nominal	Cooling Capacity	kW	8.0
	Heating Capacity	kW	9.0
UK	Cooling Total/Sensible	kW	7.3/5.0
	Heating	kW	6.1
Electrical	Power Input	kW	0.045
	Run Current	Amps	0.39
	Start Current	Amps	0.60

### Indoor Data

Airflow	High - Medium - Low	l/s	292 - 233 - 205
	High - Medium - Low	m3/h	1050 - 840 - 738
Sound	Pressure High - Medium - Low	dB(A)	38 - 35 - 33
	Power High - Medium - Low	dB(A)	53 - 50 - 48
Unit	Height x Width x Depth	mm	345 x 1180 x 570
	Weight	kg	26
Panel	Type	RBC-	UW803PG(W)-E
	Height x Width x Depth	mm	20 x 1415 x 680
	Weight	kg	14
Pipe Connection	Flare Connections (gas - liquid)	inch	5/8 - 3/8
	Drain Pipe Connection OD/ID	mm	32/25
Power Supply	Suggested Fuse Size	V/ph/Hz-A	220-240/1/50-5

### Accessories

<a href="#">RBC-AMTU31-E</a>	Standard Remote Controller - Full control including service functions
<a href="#">RBC-ASCU11-E</a>	Compact Remote Controller - Includes timer off, back light display, multilingual
<a href="#">RBC-AWSU52-E</a>	Premium Controller - Includes timer and back light display, multilingual (inc. Bluetooth)
<a href="#">RBC-MTSC1</a>	Mini Touch Screen Controller - with configurable icons for indoor units
<a href="#">RBC-MTSC2</a>	Mini Touch Screen Controller - with Schedule Timer, configurable icons for indoor units
<a href="#">TCB-FF151US-E</a>	Auxiliary fresh air flange - For Fresh air intake by using the knock out hole of indoor unit
<a href="#">TBC-LF**3UW-E</a>	Super Long Life Filter - Dust collecting effect 50% (Weight method) - Use with TBC-FC**3UW-E
<a href="#">TBC-FC**3UW-E</a>	Filter chamber - Chamber for Super long life filter - Use with TBC-LF**3UW-E

\*All [Accessories](#) / [Controls](#)

Compatible R410a outdoor condensers:

[Mini SMMS-e](#), [SMMS-u](#), [SHRM-e](#)

Compatible R32 outdoor condensers:

[Mini SMMS](#), [SHRM-a](#)

Related items:

- [Full specification](#)
- [BIM files](#)
- [CAD files](#)
- [Airflow/ fan curve](#)
- [Dimensional drawing](#)
- [Wiring diagram](#)
- [Noise curve data](#)
- [Installation manual](#)

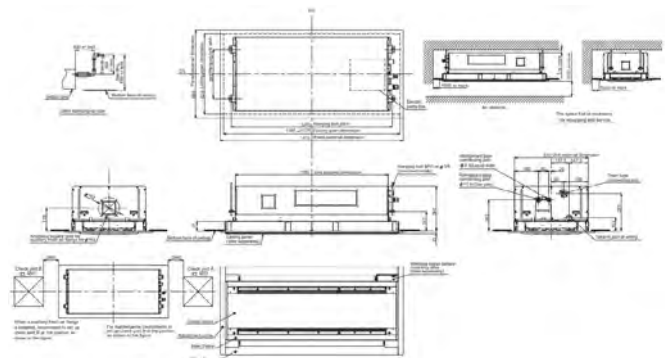

## VRF 2-WAY CASSETTE: MMU - UPO301WH-E

- Compact dimensions (height 345mm).
- Minimal weight (26 kg) for units up to 10kw.
- Enhanced indoor air quality with standard long-life filters.
- Unique air flow control, provides a balanced flow of air in two opposite directions.
- The elegant white decorative panel allows the unit to be installed seamlessly into any room.



Hi - Res Image 



### Performance Data

Capacity Code		HP	3.2
Nominal	Cooling Capacity	kW	9.0
	Heating Capacity	kW	10.0
UK	Cooling Total/Sensible	kW	8.2/5.4
	Heating	kW	6.8
Electrical	Power Input	kW	0.055
	Run Current	Amps	0.46
	Start Current	Amps	0.68

### Indoor Data

Airflow	High - Medium - Low	l/s	350 - 250 - 217
	High - Medium - Low	m3/h	1260 - 900 - 780
Sound	Pressure High - Medium - Low	dB(A)	40 - 37 - 34
	Power High - Medium - Low	dB(A)	55 - 52 - 49
Unit	Height x Width x Depth	mm	345 x 1180 x 570
	Weight	kg	26
Panel	Type	RBC-	UW803PG(W)-E
	Height x Width x Depth	mm	20 x 1415 x 680
	Weight	kg	14
Pipe Connection	Flare Connections (gas - liquid)	inch	5/8 - 3/8
	Drain Pipe Connection OD/ID	mm	32/25
Power Supply	Suggested Fuse Size	V/ph/Hz-A	220-240/1/50-5

### Accessories

<a href="#">RBC-AMTU31-E</a>	Standard Remote Controller - Full control including service functions
<a href="#">RBC-ASCU11-E</a>	Compact Remote Controller - Includes timer off, back light display, multilingual
<a href="#">RBC-AWSU52-E</a>	Premium Controller - Includes timer and back light display, multilingual (inc. Bluetooth)
<a href="#">RBC-MTSC1</a>	Mini Touch Screen Controller - with configurable icons for indoor units
<a href="#">RBC-MTSC2</a>	Mini Touch Screen Controller - with Schedule Timer, configurable icons for indoor units
<a href="#">TCB-FF151US-E</a>	Auxiliary fresh air flange - For Fresh air intake by using the knock out hole of indoor unit
<a href="#">TBC-LF**3UW-E</a>	Super Long Life Filter - Dust collecting effect 50% (Weight method) - Use with TBC-FC**3UW-E
<a href="#">TBC-FC**3UW-E</a>	Filter chamber - Chamber for Super long life filter - Use with TBC-LF**3UW-E

\*All [Accessories](#) / [Controls](#)

Compatible R410a outdoor condensers:

[Mini SMMS-e](#), [SMMS-u](#), [SHRM-e](#)

Compatible R32 outdoor condensers:

[Mini SMMS](#), [SHRM-a](#)

Related items:

- [Full specification](#)
- [BIM files](#)
- [CAD files](#)
- [Airflow/ fan curve](#)
- [Dimensional drawing](#)
- [Wiring diagram](#)
- [Noise curve data](#)
- [Installation manual](#)

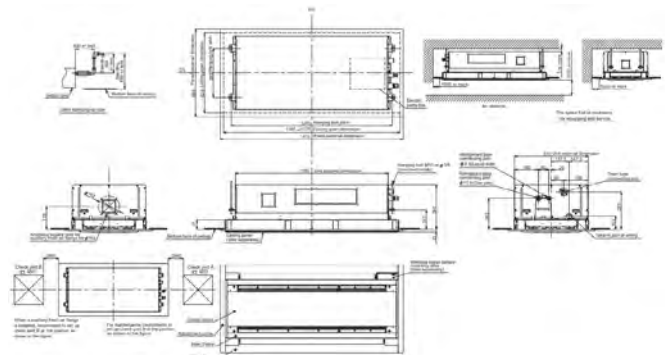



## VRF 2-WAY CASSETTE: MMU - UP0361WH-E

- Compact dimensions (height 345mm).
- Minimal weight (36 kg) for units up to 18kw.
- Enhanced indoor air quality with standard long-life filters.
- Unique air flow control, provides a balanced flow of air in two opposite directions.
- The elegant white decorative panel allows the unit to be installed seamlessly into any room.



Hi - Res Image 



### Performance Data

Capacity Code		HP	4.0
Nominal	Cooling Capacity	kW	11.2
	Heating Capacity	kW	12.5
UK	Cooling Total/Sensible	kW	10.2/7.3
	Heating	kW	8.5
	Power Input	kW	0.081
Electrical	Run Current	Amps	0.53
	Start Current	Amps	0.79

### Indoor Data

Airflow	High - Medium - Low	l/s	483 - 398 - 328
	High - Medium - Low	m <sup>3</sup> /h	1740 - 1434 - 1182
Sound	Pressure High - Medium - Low	dB(A)	42 - 39 - 36
	Power High - Medium - Low	dB(A)	57 - 54 - 51
Unit	Height x Width x Depth	mm	345 x 1600 x 570
	Weight	kg	36
Panel	Type	RBC-	UW1403PG(W)-E
	Height x Width x Depth	mm	20 x 1835 x 680
	Weight	kg	14
Pipe Connection	Flare Connections (gas - liquid)	inch	5/8 - 3/8
	Drain Pipe Connection OD/ID	mm	32/25
Power Supply	Suggested Fuse Size	V/ph/Hz-A	220-240/1/50-5

### Accessories

<a href="#">RBC-AMTU31-E</a>	Standard Remote Controller - Full control including service functions
<a href="#">RBC-ASCU11-E</a>	Compact Remote Controller - Includes timer off, back light display, multilingual
<a href="#">RBC-AWSU52-E</a>	Premium Controller - Includes timer and back light display, multilingual (inc. Bluetooth)
<a href="#">RBC-MTSC1</a>	Mini Touch Screen Controller - with configurable icons for indoor units
<a href="#">RBC-MTSC2</a>	Mini Touch Screen Controller - with Schedule Timer, configurable icons for indoor units
<a href="#">TCB-FF151US-E</a>	Auxiliary fresh air flange - For Fresh air intake by using the knock out hole of indoor unit
<a href="#">TBC-LF**3UW-E</a>	Super Long Life Filter - Dust collecting effect 50% (Weight method) - Use with TBC-FC**3UW-E
<a href="#">TBC-FC**3UW-E</a>	Filter chamber - Chamber for Super long life filter - Use with TBC-LF**3UW-E

\*All [Accessories](#) / [Controls](#)

Compatible R410a outdoor condensers:

[Mini SMMS-e](#), [SMMS-u](#), [SHRM-e](#)

Compatible R32 outdoor condensers:

[Mini SMMS](#), [SHRM-a](#)

Related items:

- [Full specification](#)
- [BIM files](#)
- [CAD files](#)
- [Airflow/ fan curve](#)
- [Dimensional drawing](#)
- [Wiring diagram](#)
- [Noise curve data](#)
- [Installation manual](#)

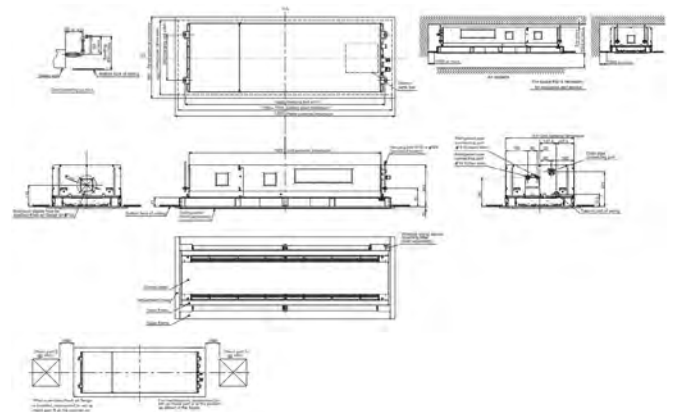

## VRF 2-WAY CASSETTE: MMU - UPO481WH-E

- Compact dimensions (height 345mm).
- Minimal weight (36 kg) for units up to 18kw.
- Enhanced indoor air quality with standard long-life filters.
- Unique air flow control, provides a balanced flow of air in two opposite directions.
- The elegant white decorative panel allows the unit to be installed seamlessly into any room.



Hi - Res Image 



### Performance Data

Capacity Code		HP	5.0
Nominal	Cooling Capacity	kW	14.0
	Heating Capacity	kW	16.0
UK	Cooling Total/Sensible	kW	12.7/8.5
	Heating	kW	10.9
Electrical	Power Input	kW	0.091
	Run Current	Amps	0.59
	Start Current	Amps	0.89

### Indoor Data

Airflow	High - Medium - Low	l/s	500 - 412 - 342
	High - Medium - Low	m3/h	1800 - 1482 - 1230
Sound	Pressure High - Medium - Low	dB(A)	43 - 40 - 37
	Power High - Medium - Low	dB(A)	58 - 55 - 52
Unit	Height x Width x Depth	mm	345 x 1600 x 570
	Weight	kg	36
Panel	Type	RBC-	UW1403PG(W)-E
	Height x Width x Depth	mm	20 x 1835 x 680
	Weight	kg	14
Pipe Connection	Flare Connections (gas - liquid)	inch	5/8 - 3/8
	Drain Pipe Connection OD/ID	mm	32/25
Power Supply	Suggested Fuse Size	V/ph/Hz-A	220-240/1/50-5

### Accessories

<a href="#">RBC-AMTU31-E</a>	Standard Remote Controller - Full control including service functions
<a href="#">RBC-ASCU11-E</a>	Compact Remote Controller - Includes timer off, back light display, multilingual
<a href="#">RBC-AWSU52-E</a>	Premium Controller - Includes timer and back light display, multilingual (inc. Bluetooth)
<a href="#">RBC-MTSC1</a>	Mini Touch Screen Controller - with configurable icons for indoor units
<a href="#">RBC-MTSC2</a>	Mini Touch Screen Controller - with Schedule Timer, configurable icons for indoor units
<a href="#">TCB-FF151US-E</a>	Auxiliary fresh air flange - For Fresh air intake by using the knock out hole of indoor unit
<a href="#">TBC-LF**3UW-E</a>	Super Long Life Filter - Dust collecting effect 50% (Weight method) - Use with TBC-FC**3UW-E
<a href="#">TBC-FC**3UW-E</a>	Filter chamber - Chamber for Super long life filter - Use with TBC-LF**3UW-E

\*All [Accessories](#) / [Controls](#)

Compatible R410a outdoor condensers:

[Mini SMMS-e](#), [SMMS-u](#), [SHRM-e](#)

Compatible R32 outdoor condensers:

[Mini SMMS](#), [SHRM-a](#)

Related items:

- [Full specification](#)
- [BIM files](#)
- [CAD files](#)
- [Airflow/ fan curve](#)
- [Dimensional drawing](#)
- [Wiring diagram](#)
- [Noise curve data](#)
- [Installation manual](#)

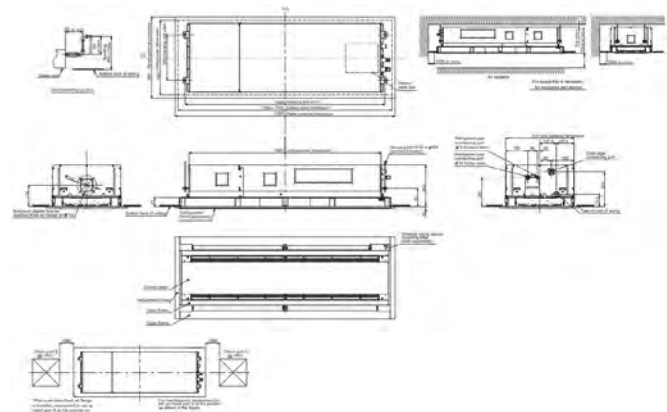

## VRF 2-WAY CASSETTE: MMU - UP0561WH-E

- Compact dimensions (height 345mm).
- Minimal weight (36 kg) for units up to 18kw.
- Enhanced indoor air quality with standard long-life filters.
- Unique air flow control, provides a balanced flow of air in two opposite directions.
- The elegant white decorative panel allows the unit to be installed seamlessly into any room.



Hi - Res Image 



### Performance Data

Capacity Code		HP	6.0
Nominal	Cooling Capacity	kW	16.0
	Heating Capacity	kW	18.0
UK	Cooling Total/Sensible	kW	14.5/9.4
	Heating	kW	12.2
Electrical	Power Input	kW	0.131
	Run Current	Amps	0.81
	Start Current	Amps	1.22

### Indoor Data

Airflow	High - Medium - Low	l/s	567 - 438 - 367
	High - Medium - Low	m3/h	2040 - 1578 - 1320
Sound	Pressure High - Medium - Low	dB(A)	46 - 42 - 39
	Power High - Medium - Low	dB(A)	61 - 57 - 54
Unit	Height x Width x Depth	mm	345 x 1600 x 570
	Weight	kg	36
Panel	Type	RBC-	UW1403PG(W)-E
	Height x Width x Depth	mm	20 x 1835 x 680
	Weight	kg	14
Pipe Connection	Flare Connections (gas - liquid)	inch	5/8 - 3/8
	Drain Pipe Connection OD/ID	mm	32/25
Power Supply	Suggested Fuse Size	V/ph/Hz-A	220-240/1/50-5

### Accessories

<a href="#">RBC-AMTU31-E</a>	Standard Remote Controller - Full control including service functions
<a href="#">RBC-ASCU11-E</a>	Compact Remote Controller - Includes timer off, back light display, multilingual
<a href="#">RBC-AWSU52-E</a>	Premium Controller - Includes timer and back light display, multilingual (inc. Bluetooth)
<a href="#">RBC-MTSC1</a>	Mini Touch Screen Controller - with configurable icons for indoor units
<a href="#">RBC-MTSC2</a>	Mini Touch Screen Controller - with Schedule Timer, configurable icons for indoor units
<a href="#">TCB-FF151US-E</a>	Auxiliary fresh air flange - For Fresh air intake by using the knock out hole of indoor unit
<a href="#">TBC-LF**3UW-E</a>	Super Long Life Filter - Dust collecting effect 50% (Weight method) - Use with TBC-FC**3UW-E
<a href="#">TBC-FC**3UW-E</a>	Filter chamber - Chamber for Super long life filter - Use with TBC-LF**3UW-E

\*All [Accessories](#) / [Controls](#)

Compatible R410a outdoor condensers:

[Mini SMMS-e](#), [SMMS-u](#), [SHRM-e](#)

Compatible R32 outdoor condensers:

[Mini SMMS](#), [SHRM-a](#)

Related items:

- [Full specification](#)
- [BIM files](#)
- [CAD files](#)
- [Airflow/ fan curve](#)
- [Dimensional drawing](#)
- [Wiring diagram](#)
- [Noise curve data](#)
- [Installation manual](#)

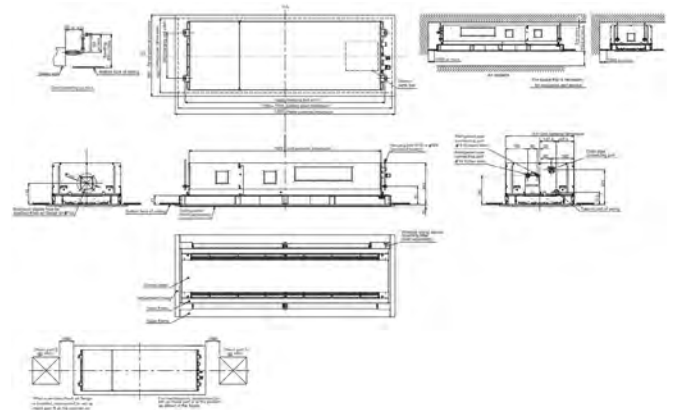

# 4-Way Compact Cassette



## VRF 4-WAY COMPACT CASSETTE: MMU - UP0051MH-E

- 5-step flow with individual louvre swing control.
- Fit within the T-bar of grid ceiling: 620mm X 620mm.
- Lightweight unit, for easy and quick installation with built in high lift drain pump.
- At only 256mm height, this compact chassis is perfectly suited to confined spaces.
- Smart flat panel design with clean lines that will complement any decorative style.



Hi - Res Image 



### Performance Data

Capacity Code		HP	0.6
Nominal	Cooling Capacity	kW	1.7
	Heating Capacity	kW	1.9
UK	Cooling Total/Sensible	kW	1.5/1.3
	Heating	kW	1.3
Electrical	Power Input	kW	0.016
	Run Current	Amps	0.16
	Start Current	Amps	0.28

### Indoor Data

Airflow	High - Medium - Low	l/s	120 - 112 - 102
	High - Medium - Low	m3/h	430 - 400 - 365
Sound	Pressure High - Medium - Low	dB(A)	32 - 30 - 29
	Power High - Medium - Low	dB(A)	47 - 45 - 44
Unit	Height x Width x Depth	mm	256 x 575 x 575
	Weight	kg	15
Panel	Height x Width x Depth	mm	12 x 620 x 620
	Weight RBC-UM21PG(W)-E	kg	2.5
Pipe Connection	Flare Connections (gas - liquid)	inch	3/8 - 1/4
	Drain Pipe Connection ID	mm	VP20
Power Supply	Suggested Fuse Size	V/ph/Hz-A	220-240/1/50-3

### Accessories

<a href="#">RBC-AMTU31-E</a>	Standard Remote Controller - Full control including service functions
<a href="#">RBC-ASCU11-E</a>	Compact Remote Controller - Includes timer off, back light display, multilingual
<a href="#">RBC-AWSU52-E</a>	Premium Controller - Includes timer and back light display, multilingual (inc. Bluetooth)
<a href="#">RBC-MTSC1</a>	Mini Touch Screen Controller - with configurable icons for indoor units
<a href="#">RBC-MTSC2</a>	Mini Touch Screen Controller - with Schedule Timer, configurable icons for indoor units
<a href="#">TCB-SIR41UM-E</a>	Occupancy sensor - Cannot be used with wireless remote control kit
<a href="#">RBC-AXU31UM-E</a>	Wireless Remote Control kit - Cannot be used with Occupancy sensor
<a href="#">TCB-FF101URE2</a>	Auxiliary fresh air flange - For easy fresh air intake by using knock out hole of indoor

\*All [Accessories](#) / [Controls](#)

Compatible R410a outdoor condensers:

[Mini SMMS-e](#), [SMMS-u](#), [SHRM-e](#)

Compatible R32 outdoor condensers:

[Mini SMMS](#), [SHRM-a](#)

Related items:

- [Full specification](#)
- [BIM files](#)
- [Airflow/ fan curve](#)
- [Dimensional drawing](#)
- [Wiring diagram](#)
- [Noise curve data](#)
- [Installation manual](#)

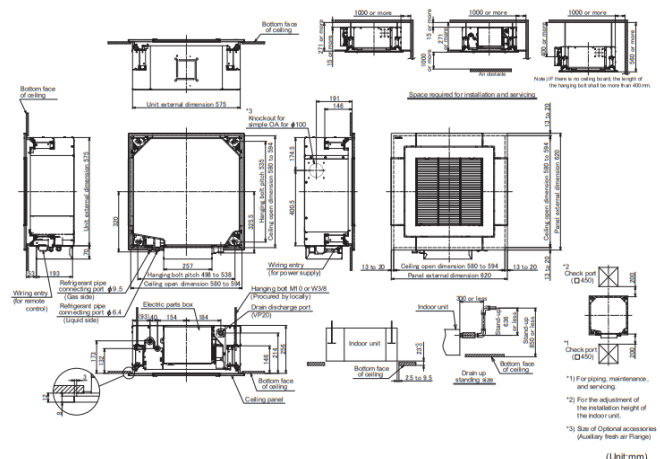

## VRF 4-WAY COMPACT CASSETTE: MMU - UP0071MH-E

- 5-step flow with individual louvre swing control.
- Fit within the T-bar of grid ceiling: 620mm X 620mm.
- Lightweight unit, for easy and quick installation with built in high lift drain pump.
- At only 256mm height, this compact chassis is perfectly suited to confined spaces.
- Smart flat panel design with clean lines that will complement any decorative style.



Hi - Res Image



### Performance Data

Capacity Code		HP	0.8
Nominal	Cooling Capacity	kW	2.2
	Heating Capacity	kW	2.5
UK	Cooling Total/Sensible	kW	2.0/1.7
	Heating	kW	1.3
Electrical	Power Input	kW	0.023
	Run Current	Amps	0.23
	Start Current	Amps	0.41

### Indoor Data

Airflow	High - Medium - Low	l/s	153 - 128 - 105
	High - Medium - Low	m <sup>3</sup> /h	552 - 462 - 378
Sound	Pressure High - Medium - Low	dB(A)	37 - 33 - 29
	Power High - Medium - Low	dB(A)	52 - 48 - 44
Unit	Height x Width x Depth	mm	256 x 575 x 575
	Weight	kg	15
Panel	Height x Width x Depth	mm	12 x 620 x 620
	Weight RBC-UM21PG(W)-E	kg	2.5
Pipe Connection	Flare Connections (gas - liquid)	inch	3/8 - 1/4
	Drain Pipe Connection ID	mm	VP20
Power Supply	Suggested Fuse Size	V/ph/Hz-A	220-240/1/50-3

### Accessories

<a href="#">RBC-AMTU31-E</a>	Standard Remote Controller - Full control including service functions
<a href="#">RBC-ASCU11-E</a>	Compact Remote Controller - Includes timer off, back light display, multilingual
<a href="#">RBC-AWSU52-E</a>	Premium Controller - Includes timer and back light display, multilingual (inc. Bluetooth)
<a href="#">RBC-MTSC1</a>	Mini Touch Screen Controller - with configurable icons for indoor units
<a href="#">RBC-MTSC2</a>	Mini Touch Screen Controller - with Schedule Timer, configurable icons for indoor units
<a href="#">TCB-SIR41UM-E</a>	Occupancy sensor - Cannot be used with wireless remote control kit
<a href="#">RBC-AXU31UM-E</a>	Wireless Remote Control kit - Cannot be used with Occupancy sensor
<a href="#">TCB-FF101URE2</a>	Auxiliary fresh air flange - For easy fresh air intake by using knock out hole of indoor

\*All [Accessories / Controls](#)

Compatible R410a outdoor condensers:

**[Mini SMMS-e](#), [SMMS-u](#), [SHRM-e](#)**

Compatible R32 outdoor condensers:

**[Mini SMMS](#), [SHRM-a](#)**

Related items:

- [Full specification](#)
- [BIM files](#)
- [Airflow/ fan curve](#)
- [Dimensional drawing](#)
- [Wiring diagram](#)
- [Noise curve data](#)
- [Installation manual](#)

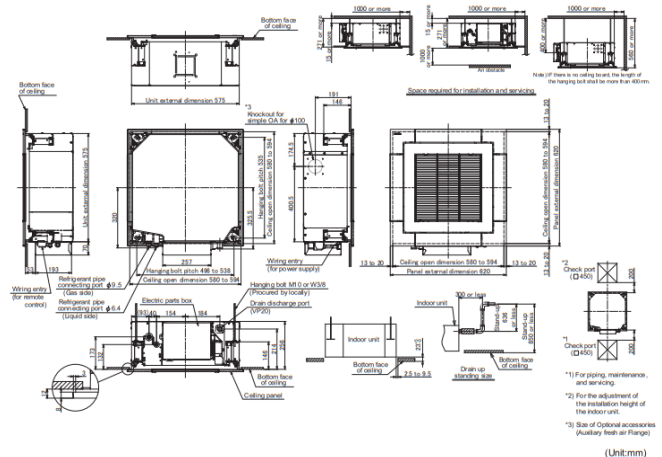

## VRF 4-WAY COMPACT CASSETTE: MMU - UP0091MH-E

- 5-step flow with individual louvre swing control.
- Fit within the T-bar of grid ceiling: 620mm X 620mm.
- Lightweight unit, for easy and quick installation with built in high lift drain pump.
- At only 256mm height, this compact chassis is perfectly suited to confined spaces.
- Smart flat panel design with clean lines that will complement any decorative style.



Hi - Res Image



### Performance Data

Capacity Code		HP	1.0
Nominal	Cooling Capacity	kW	2.8
	Heating Capacity	kW	3.2
UK	Cooling Total/Sensible	kW	2.5/2.1
	Heating	kW	1.7
Electrical	Power Input	kW	0.025
	Run Current	Amps	0.24
	Start Current	Amps	0.43

### Indoor Data

Airflow	High - Medium - Low	l/s	158 - 130 - 105
	High - Medium - Low	m3/h	570 - 468 - 378
Sound	Pressure High - Medium - Low	dB(A)	38 - 33 - 29
	Power High - Medium - Low	dB(A)	53 - 48 - 44
Unit	Height x Width x Depth	mm	256 x 575 x 575
	Weight	kg	15
Panel	Height x Width x Depth	mm	12 x 620 x 620
	Weight RBC-UM21PG(W)-E	kg	2.5
Pipe Connection	Flare Connections (gas - liquid)	inch	3/8 - 1/4
	Drain Pipe Connection ID	mm	VP20
Power Supply	Suggested Fuse Size	V/ph/Hz-A	220-240/1/50-3

### Accessories

<a href="#">RBC-AMTU31-E</a>	Standard Remote Controller - Full control including service functions
<a href="#">RBC-ASCU11-E</a>	Compact Remote Controller - Includes timer off, back light display, multilingual
<a href="#">RBC-AWSU52-E</a>	Premium Controller - Includes timer and back light display, multilingual (inc. Bluetooth)
<a href="#">RBC-MTSC1</a>	Mini Touch Screen Controller - with configurable icons for indoor units
<a href="#">RBC-MTSC2</a>	Mini Touch Screen Controller - with Schedule Timer, configurable icons for indoor units
<a href="#">TCB-SIR41UM-E</a>	Occupancy sensor - Cannot be used with wireless remote control kit
<a href="#">RBC-AXU31UM-E</a>	Wireless Remote Control kit - Cannot be used with Occupancy sensor
<a href="#">TCB-FF101URE2</a>	Auxiliary fresh air flange - For easy fresh air intake by using knock out hole of indoor

\*All [Accessories / Controls](#)

Compatible R410a outdoor condensers:

[Mini SMMS-e](#), [SMMS-u](#), [SHRM-e](#)

Compatible R32 outdoor condensers:

[Mini SMMS](#), [SHRM-a](#)

Related items:

- [Full specification](#)
- [BIM files](#)
- [Airflow/ fan curve](#)
- [Dimensional drawing](#)
- [Wiring diagram](#)
- [Noise curve data](#)
- [Installation manual](#)

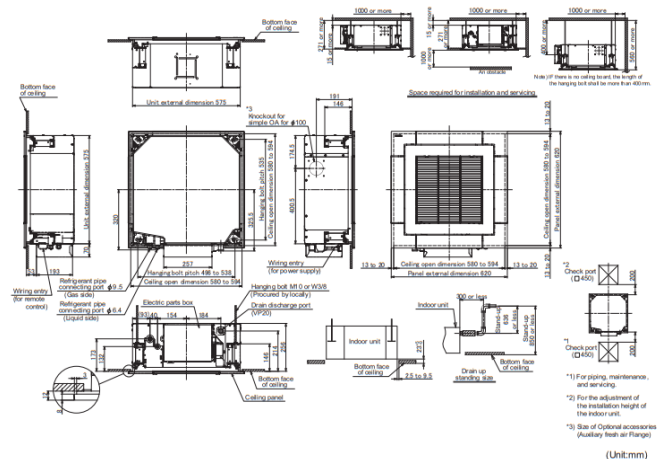

## VRF 4-WAY COMPACT CASSETTE: MMU - UP0121MH-E

- 5-step flow with individual louvre swing control.
- Fit within the T-bar of grid ceiling: 620mm X 620mm.
- Lightweight unit, for easy and quick installation with built in high lift drain pump.
- At only 256mm height, this compact chassis is perfectly suited to confined spaces.
- Smart flat panel design with clean lines that will complement any decorative style.



Hi - Res Image 



### Performance Data

Capacity Code		HP	1.3
Nominal	Cooling Capacity	kW	3.6
	Heating Capacity	kW	4.0
UK	Cooling Total/Sensible	kW	3.3/2.5
	Heating	kW	2.2
Electrical	Power Input	kW	0.027
	Run Current	Amps	0.25
	Start Current	Amps	0.44

### Indoor Data

Airflow	High - Medium - Low	l/s	165 - 140 - 112
	High - Medium - Low	m <sup>3</sup> /h	594 - 504 - 402
Sound	Pressure High - Medium - Low	dB(A)	38 - 34 - 30
	Power High - Medium - Low	dB(A)	53 - 49 - 45
Unit	Height x Width x Depth	mm	256 x 575 x 575
	Weight	kg	15
Panel	Height x Width x Depth	mm	12 x 620 x 620
	Weight RBC-UM21PG(W)-E	kg	2.5
Pipe Connection	Flare Connections (gas - liquid)	inch	3/8 - 1/4
	Drain Pipe Connection ID	mm	VP20
Power Supply	Suggested Fuse Size	V/ph/Hz-A	220-240/1/50-3

### Accessories

<a href="#">RBC-AMTU31-E</a>	Standard Remote Controller - Full control including service functions
<a href="#">RBC-ASCU11-E</a>	Compact Remote Controller - Includes timer off, back light display, multilingual
<a href="#">RBC-AWSU52-E</a>	Premium Controller - Includes timer and back light display, multilingual (inc. Bluetooth)
<a href="#">RBC-MTSC1</a>	Mini Touch Screen Controller - with configurable icons for indoor units
<a href="#">RBC-MTSC2</a>	Mini Touch Screen Controller - with Schedule Timer, configurable icons for indoor units
<a href="#">TCB-SIR41UM-E</a>	Occupancy sensor - Cannot be used with wireless remote control kit
<a href="#">RBC-AXU31UM-E</a>	Wireless Remote Control kit - Cannot be used with Occupancy sensor
<a href="#">TCB-FF101URE2</a>	Auxiliary fresh air flange - For easy fresh air intake by using knock out hole of indoor

\*All [Accessories](#) / [Controls](#)

Compatible R410a outdoor condensers:

[Mini SMMS-e](#), [SMMS-u](#), [SHRM-e](#)

Compatible R32 outdoor condensers:

[Mini SMMS](#), [SHRM-a](#)

Related items:

- [Full specification](#)
- [BIM files](#)
- [Airflow/ fan curve](#)
- [Dimensional drawing](#)
- [Wiring diagram](#)
- [Noise curve data](#)
- [Installation manual](#)

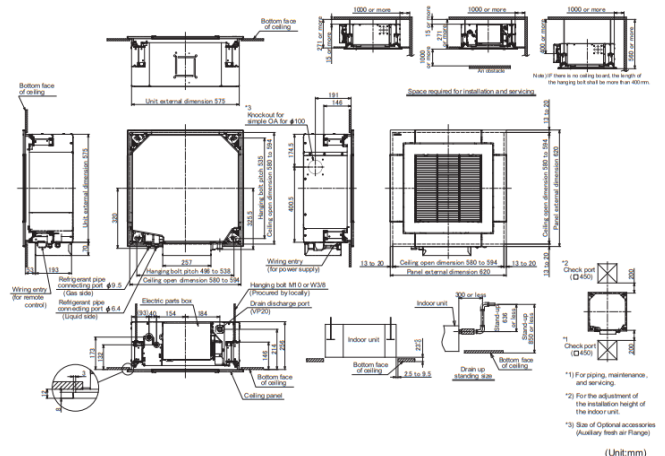



## VRF 4-WAY COMPACT CASSETTE: MMU - UP0151MH-E

- 5-step flow with individual louvre swing control.
- Fit within the T-bar of grid ceiling: 620mm X 620mm.
- Lightweight unit, for easy and quick installation with built in high lift drain pump.
- At only 256mm height, this compact chassis is perfectly suited to confined spaces.
- Smart flat panel design with clean lines that will complement any decorative style.



Hi - Res Image



### Performance Data

Capacity Code		HP	1.7
Nominal	Cooling Capacity	kW	4.5
	Heating Capacity	kW	5.0
UK	Cooling Total/Sensible	kW	4.1/3.1
	Heating	kW	2.7
Electrical	Power Input	kW	0.030
	Run Current	Amps	0.28
	Start Current	Amps	0.50

### Indoor Data

Airflow	High - Medium - Low	l/s	183 - 153 - 130
	High - Medium - Low	m <sup>3</sup> /h	660 - 552 - 468
Sound	Pressure High - Medium - Low	dB(A)	40 - 35 - 31
	Power High - Medium - Low	dB(A)	55 - 50 - 46
Unit	Height x Width x Depth	mm	256 x 575 x 575
	Weight	kg	15
Panel	Height x Width x Depth	mm	12 x 620 x 620
	Weight RBC-UM21PG(W)-E	kg	2.5
Pipe Connection	Flare Connections (gas - liquid)	inch	1/2 - 1/4
	Drain Pipe Connection ID	mm	VP20
Power Supply	Suggested Fuse Size	V/ph/Hz-A	220-240/1/50-3

### Accessories

<a href="#">RBC-AMTU31-E</a>	Standard Remote Controller - Full control including service functions
<a href="#">RBC-ASCU11-E</a>	Compact Remote Controller - Includes timer off, back light display, multilingual
<a href="#">RBC-AWSU52-E</a>	Premium Controller - Includes timer and back light display, multilingual (inc. Bluetooth)
<a href="#">RBC-MTSC1</a>	Mini Touch Screen Controller - with configurable icons for indoor units
<a href="#">RBC-MTSC2</a>	Mini Touch Screen Controller - with Schedule Timer, configurable icons for indoor units
<a href="#">TCB-SIR41UM-E</a>	Occupancy sensor - Cannot be used with wireless remote control kit
<a href="#">RBC-AXU31UM-E</a>	Wireless Remote Control kit - Cannot be used with Occupancy sensor
<a href="#">TCB-FF101URE2</a>	Auxiliary fresh air flange - For easy fresh air intake by using knock out hole of indoor

\*All [Accessories / Controls](#)

Compatible R410a outdoor condensers:

**[Mini SMMS-e](#), [SMMS-u](#), [SHRM-e](#)**

Compatible R32 outdoor condensers:

**[Mini SMMS](#), [SHRM-a](#)**

Related items:

- [Full specification](#)
- [BIM files](#)
- [Airflow/ fan curve](#)
- [Dimensional drawing](#)
- [Wiring diagram](#)
- [Noise curve data](#)
- [Installation manual](#)

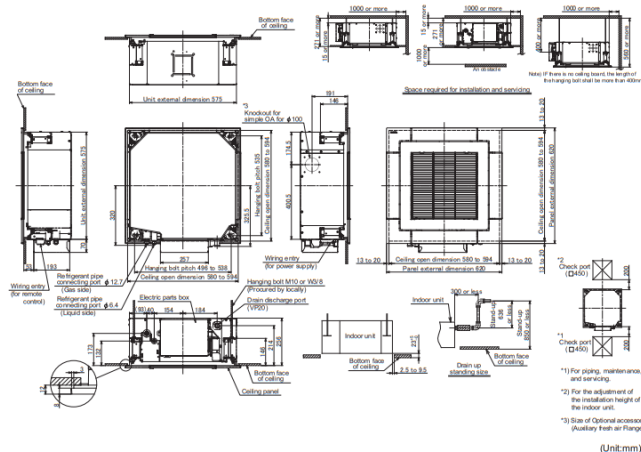

## VRF 4-WAY COMPACT CASSETTE: MMU - UP0181MH-E

- 5-step flow with individual louvre swing control.
- Fit within the T-bar of grid ceiling: 620mm X 620mm.
- Lightweight unit, for easy and quick installation with built in high lift drain pump.
- At only 256mm height, this compact chassis is perfectly suited to confined spaces.
- Smart flat panel design with clean lines that will complement any decorative style.



Hi - Res Image 



### Performance Data

Capacity Code		HP	2.0
Nominal	Cooling Capacity	kW	5.6
	Heating Capacity	kW	6.3
UK	Cooling Total/Sensible	kW	5.1/3.9
	Heating	kW	3.4
Electrical	Power Input	kW	0.052
	Run Current	Amps	0.46
	Start Current	Amps	0.80

### Indoor Data

Airflow	High - Medium - Low	l/s	233 - 167 - 145
	High - Medium - Low	m3/h	840 - 642 - 522
Sound	Pressure High - Medium - Low	dB(A)	47 - 39 - 34
	Power High - Medium - Low	dB(A)	62 - 54 - 49
Unit	Height x Width x Depth	mm	256 x 575 x 575
	Weight	kg	15
Panel	Height x Width x Depth	mm	12 x 620 x 620
	Weight RBC-UM21PG(W)-E	kg	2.5
Pipe Connection	Flare Connections (gas - liquid)	inch	1/2 - 1/4
	Drain Pipe Connection OD/ID	mm	VP20
Power Supply	Suggested Fuse Size	V/ph/Hz-A	220-240/1/50-3

### Accessories

<a href="#">RBC-AMTU31-E</a>	Standard Remote Controller - Full control including service functions
<a href="#">RBC-ASCU11-E</a>	Compact Remote Controller - Includes timer off, back light display, multilingual
<a href="#">RBC-AWSU52-E</a>	Premium Controller - Includes timer and back light display, multilingual (inc. Bluetooth)
<a href="#">RBC-MTSC1</a>	Mini Touch Screen Controller - with configurable icons for indoor units
<a href="#">RBC-MTSC2</a>	Mini Touch Screen Controller - with Schedule Timer, configurable icons for indoor units
<a href="#">TCB-SIR41UM-E</a>	Occupancy sensor - Cannot be used with wireless remote control kit
<a href="#">RBC-AXU31UM-E</a>	Wireless Remote Control kit - Cannot be used with Occupancy sensor
<a href="#">TCB-FF101URE2</a>	Auxiliary fresh air flange - For easy fresh air intake by using knock out hole of indoor

\*All [Accessories / Controls](#)

Compatible R410a outdoor condensers:

[Mini SMMS-e](#), [SMMS-u](#), [SHRM-e](#)

Compatible R32 outdoor condensers:

[Mini SMMS](#), [SHRM-a](#)

Related items:

- [Full specification](#)
- [BIM files](#)
- [Airflow/ fan curve](#)
- [Dimensional drawing](#)
- [Wiring diagram](#)
- [Noise curve data](#)
- [Installation manual](#)

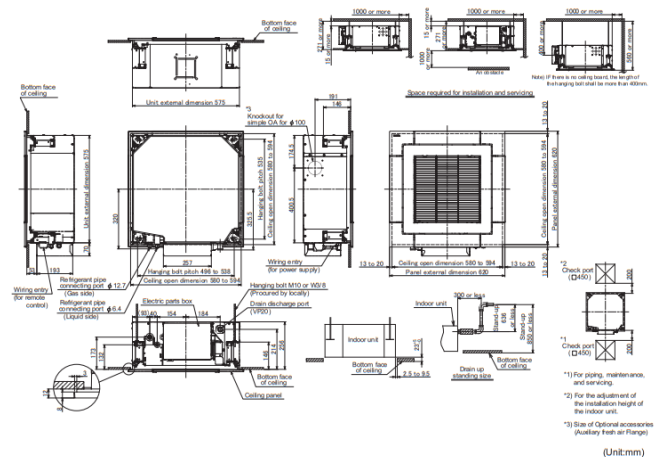

# 4-Way Standard Cassette



## VRF 4-WAY STANDARD CASSETTE: MMU - UP0091HP-E

- Possible to set three different swing modes.
- Optimal air diffusion up to 4.6m ceiling height.
- Lightweight unit, for easy and quick installation.
- Compact chassis with only 256mm height (up to size 30).
- Self-cleaning function and Ag-ion tip for anti-mould in drain cap.



### Performance Data

Capacity Code		HP	1.0
Nominal	Cooling Capacity	kW	2.8
	Heating Capacity	kW	3.2
UK	Cooling Total/Sensible	kW	2.5/2.0
	Heating	kW	2.2
Electrical	Power Input	kW	0.021
	Run Current	Amps	0.23
	Start Current	Amps	0.30

### Indoor Data

Airflow	High - Medium - Low	l/s	222 - 203 - 188
	High - Medium - Low	m3/h	800 - 730 - 680
Sound	Pressure High - Medium - Low	dB(A)	30 - 29 - 27
	Power High - Medium - Low	dB(A)	45 - 44 - 42
Unit	Height x Width x Depth	mm	256 x 840 x 840
	Weight	kg	20
Panel	Height x Width x Depth	mm	30 x 950 x 950
	Weight RBC-U32PGP-E	kg	4
Pipe Connection	Flare Connections (gas - liquid)	inch	3/8 - 1/4
	Drain Pipe Connection OD/ID	mm	32/25
Power Supply	Suggested Fuse Size	V/ph/Hz-A	220-240/1/50-5

### Accessories

<a href="#">RBC-AMTU31-E</a>	Standard Remote Controller - Full control including service functions
<a href="#">RBC-ASCU11-E</a>	Compact Remote Controller - Includes timer off, back light display, multilingual
<a href="#">RBC-AWSU52-E</a>	Premium Controller - Includes timer and back light display, multilingual (inc. Bluetooth)
<a href="#">RBC-MTSC1</a>	Mini Touch Screen Controller - with configurable icons for indoor units
<a href="#">RBC-MTSC2</a>	Mini Touch Screen Controller - with Schedule Timer, configurable icons for indoor units
<a href="#">TCB-GFC1603U-E</a>	Fresh Air Chamber - Fresh Air chamber for use with TCB-GB1602UE
<a href="#">TCB-BC1602UE</a>	Air discharge direction kit - Air Discharge kit - With 6-direction patterns
<a href="#">TCB-FF101URE2</a>	Auxiliary fresh air flange - For easy fresh air intake by using knock out hole of indoor.

\*All [Accessories](#) / [Controls](#)

Compatible R410a outdoor condensers:

[Mini SMMS-e](#), [SMMS-u](#), [SHRM-e](#)

Compatible R32 outdoor condensers:

[Mini SMMS](#), [SHRM-a](#)

Related items:

- [Full specification](#)
- [BIM files](#)
- [Airflow/ fan curve](#)
- [Dimensional drawing](#)
- [Wiring diagram](#)
- [Noise curve data](#)
- [Installation manual](#)

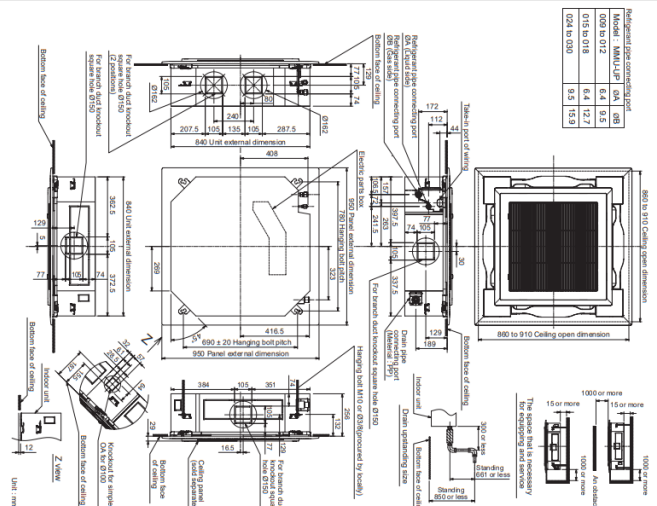

## VRF 4-WAY STANDARD CASSETTE: MMU - UP0121HP-E

- Possible to set three different swing modes.
- Optimal air diffusion up to 4.6m ceiling height.
- Lightweight unit, for easy and quick installation.
- Compact chassis with only 256mm height (up to size 30).
- Self-cleaning function and Ag-ion tip for anti-mould in drain cap.



Hi - Res Image 



### Performance Data

Capacity Code		HP	1.3
Nominal	Cooling Capacity	kW	3.6
	Heating Capacity	kW	4.0
UK	Cooling Total/Sensible	kW	3.3/2.5
	Heating	kW	2.7
Electrical	Power Input	kW	0.021
	Run Current	Amps	0.23
	Start Current	Amps	0.30

### Indoor Data

Airflow	High - Medium - Low	l/s	222 - 203 - 188
	High - Medium - Low	m3/h	800 - 730 - 680
Sound	Pressure High - Medium - Low	dB(A)	30 - 29 - 27
	Power High - Medium - Low	dB(A)	45 - 44 - 42
Unit	Height x Width x Depth	mm	256 x 840 x 840
	Weight	kg	20
Panel	Height x Width x Depth	mm	30 x 950 x 950
	Weight RBC-U32PGP-E	kg	4
Pipe Connection	Flare Connections (gas - liquid)	inch	3/8 - 1/4
	Drain Pipe Connection OD/ID	mm	32/25
Power Supply	Suggested Fuse Size	V/ph/Hz-A	220-240/1/50-5

### Accessories

<a href="#">RBC-AMTU31-E</a>	Standard Remote Controller - Full control including service functions
<a href="#">RBC-ASCU11-E</a>	Compact Remote Controller - Includes timer off, back light display, multilingual
<a href="#">RBC-AWSU52-E</a>	Premium Controller - Includes timer and back light display, multilingual (inc. Bluetooth)
<a href="#">RBC-MTSC1</a>	Mini Touch Screen Controller - with configurable icons for indoor units
<a href="#">RBC-MTSC2</a>	Mini Touch Screen Controller - with Schedule Timer, configurable icons for indoor units
<a href="#">TCB-GFC1603U-E</a>	Fresh Air Chamber - Fresh Air chamber for use with TCB-GB1602UE
<a href="#">TCB-BC1602UE</a>	Air discharge direction kit - Air Discharge kit - With 6-direction patterns
<a href="#">TCB-FF101URE2</a>	Auxiliary fresh air flange - For easy fresh air intake by using knock out hole of indoor.

\*All [Accessories](#) / [Controls](#)

Compatible R410a outdoor condensers:

[Mini SMMS-e](#), [SMMS-u](#), [SHRM-e](#)

Compatible R32 outdoor condensers:

[Mini SMMS](#), [SHRM-a](#)

Related items:

- [Full specification](#)
- [BIM files](#)
- [Airflow/ fan curve](#)
- [Dimensional drawing](#)
- [Wiring diagram](#)
- [Noise curve data](#)
- [Installation manual](#)

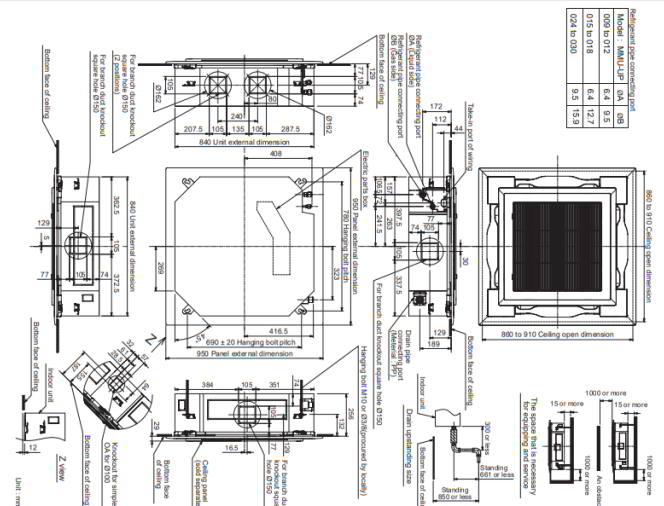

Model	Height	Width	Depth
MMU-UP0121HP-E	256	840	840
MMU-UP0121HP-E	256	840	840
MMU-UP0121HP-E	256	840	840
MMU-UP0121HP-E	256	840	840

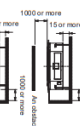

## VRF 4-WAY STANDARD CASSETTE: MMU - UP0151HP-E

- Possible to set three different swing modes.
- Optimal air diffusion up to 4.6m ceiling height.
- Lightweight unit, for easy and quick installation.
- Compact chassis with only 256mm height (up to size 30).
- Self-cleaning function and Ag-ion tip for anti-mould in drain cap.



### Performance Data

Capacity Code		HP	1.7
Nominal	Cooling Capacity	kW	4.5
	Heating Capacity	kW	5.0
UK	Cooling Total/Sensible	kW	4.1/3.0
	Heating	kW	3.4
Electrical	Power Input	kW	0.023
	Run Current	Amps	0.27
	Start Current	Amps	0.33

### Indoor Data

Airflow	High - Medium - Low	l/s	258 - 230 - 220
	High - Medium - Low	m3/h	930 - 830 - 790
Sound	Pressure High - Medium - Low	dB(A)	31 - 29 - 27
	Power High - Medium - Low	dB(A)	46 - 44 - 42
Unit	Height x Width x Depth	mm	256 x 840 x 840
	Weight	kg	20
Panel	Height x Width x Depth	mm	30 x 950 x 950
	Weight RBC-U32PGP-E	kg	4
Pipe Connection	Flare Connections (gas - liquid)	inch	1/2 - 1/4
	Drain Pipe Connection OD/ID	mm	32/25
Power Supply	Suggested Fuse Size	V/ph/Hz-A	220-240/1/50-5

### Accessories

<a href="#">RBC-AMTU31-E</a>	Standard Remote Controller - Full control including service functions
<a href="#">RBC-ASCU11-E</a>	Compact Remote Controller - Includes timer off, back light display, multilingual
<a href="#">RBC-AWSU52-E</a>	Premium Controller - Includes timer and back light display, multilingual (inc. Bluetooth)
<a href="#">RBC-MTSC1</a>	Mini Touch Screen Controller - with configurable icons for indoor units
<a href="#">RBC-MTSC2</a>	Mini Touch Screen Controller - with Schedule Timer, configurable icons for indoor units
<a href="#">TCB-GFC1603U-E</a>	Fresh Air Chamber - Fresh Air chamber for use with TCB-GB1602UE
<a href="#">TCB-BC1602UE</a>	Air discharge direction kit - Air Discharge kit - With 6-direction patterns
<a href="#">TCB-FF101URE2</a>	Auxiliary fresh air flange - For easy fresh air intake by using knock out hole of indoor.

\*All [Accessories](#) / [Controls](#)

Compatible R410a outdoor condensers:  
[Mini SMMS-e](#), [SMMS-u](#), [SHRM-e](#)

Compatible R32 outdoor condensers:  
[Mini SMMS](#), [SHRM-a](#)

Related items:

- [Full specification](#)
- [BIM files](#)
- [Airflow/ fan curve](#)
- [Dimensional drawing](#)
- [Wiring diagram](#)
- [Noise curve data](#)
- [Installation manual](#)

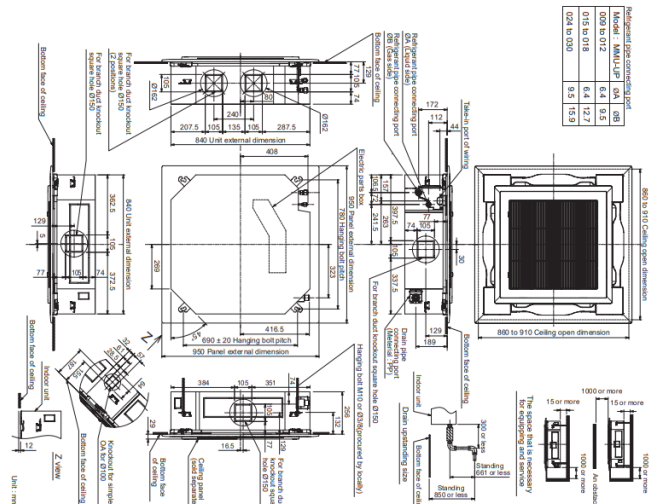

## VRF 4-WAY STANDARD CASSETTE: MMU - UP0181HP-E

- Possible to set three different swing modes.
- Optimal air diffusion up to 4.6m ceiling height.
- Lightweight unit, for easy and quick installation.
- Compact chassis with only 256mm height (up to size 30).
- Self-cleaning function and Ag-ion tip for anti-mould in drain cap.



Hi - Res Image



### Performance Data

Capacity Code		HP	2.0
Nominal	Cooling Capacity	kW	5.6
	Heating Capacity	kW	6.3
UK	Cooling Total/Sensible	kW	5.1/3.8
	Heating	kW	4.3
Electrical	Power Input	kW	0.026
	Run Current	Amps	0.29
	Start Current	Amps	0.36

### Indoor Data

Airflow	High - Medium - Low	l/s	292 - 255 - 222
	High - Medium - Low	m3/h	1050 - 920 - 800
Sound	Pressure High - Medium - Low	dB(A)	32 - 29 - 27
	Power High - Medium - Low	dB(A)	47 - 44 - 42
Unit	Height x Width x Depth	mm	256 x 840 x 840
	Weight	kg	20
Panel	Height x Width x Depth	mm	30 x 950 x 950
	Weight RBC-U32PGP-E	kg	4
Pipe Connection	Flare Connections (gas - liquid)	inch	1/2 - 1/4
	Drain Pipe Connection OD/ID	mm	32/25
Power Supply	Suggested Fuse Size	V/ph/Hz-A	220-240/1/50-5

### Accessories

<a href="#">RBC-AMTU31-E</a>	Standard Remote Controller - Full control including service functions
<a href="#">RBC-ASCU11-E</a>	Compact Remote Controller - Includes timer off, back light display, multilingual
<a href="#">RBC-AWSU52-E</a>	Premium Controller - Includes timer and back light display, multilingual (inc. Bluetooth)
<a href="#">RBC-MTSC1</a>	Mini Touch Screen Controller - with configurable icons for indoor units
<a href="#">RBC-MTSC2</a>	Mini Touch Screen Controller - with Schedule Timer, configurable icons for indoor units
<a href="#">TCB-GFC1603U-E</a>	Fresh Air Chamber - Fresh Air chamber for use with TCB-GB1602UE
<a href="#">TCB-BC1602UE</a>	Air discharge direction kit - Air Discharge kit - With 6-direction patterns
<a href="#">TCB-FF101URE2</a>	Auxiliary fresh air flange - For easy fresh air intake by using knock out hole of indoor.

\*All [Accessories](#) / [Controls](#)

Compatible R410a outdoor condensers:

[Mini SMMS-e](#), [SMMS-u](#), [SHRM-e](#)

Compatible R32 outdoor condensers:

[Mini SMMS](#), [SHRM-a](#)

Related items:

- [Full specification](#)
- [BIM files](#)
- [Airflow/ fan curve](#)
- [Dimensional drawing](#)
- [Wiring diagram](#)
- [Noise curve data](#)
- [Installation manual](#)

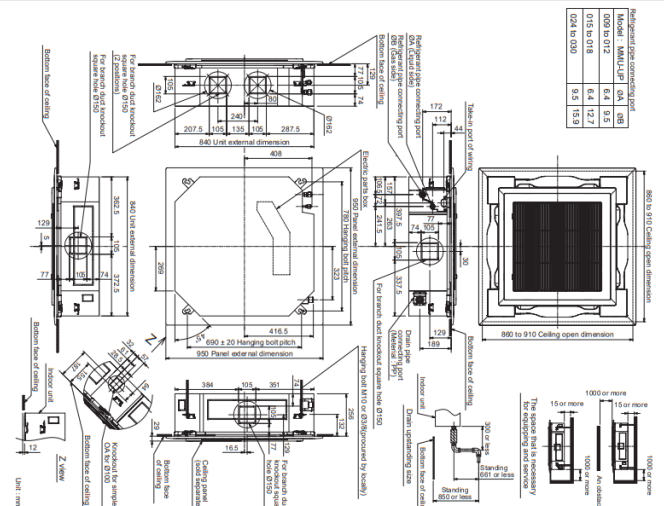

Model	Net weight (kg)	Gross weight (kg)
MMU-UP0181HP-E	19.5	20.5
MMU-UP0181HP-E	19.5	20.5
MMU-UP0181HP-E	19.5	20.5
MMU-UP0181HP-E	19.5	20.5

Model	Net weight (kg)	Gross weight (kg)
MMU-UP0181HP-E	19.5	20.5
MMU-UP0181HP-E	19.5	20.5
MMU-UP0181HP-E	19.5	20.5
MMU-UP0181HP-E	19.5	20.5

## VRF 4-WAY STANDARD CASSETTE: MMU - UPO241HP-E

- Possible to set three different swing modes.
- Optimal air diffusion up to 4.6m ceiling height.
- Lightweight unit, for easy and quick installation.
- Compact chassis with only 256mm height (up to size 30).
- Self-cleaning function and Ag-ion tip for anti-mould in drain cap.



Hi - Res Image

### Performance Data

Capacity Code		HP	2.5
Nominal	Cooling Capacity	kW	7.1
	Heating Capacity	kW	8.0
UK	Cooling Total/Sensible	kW	6.4/4.6
	Heating	kW	5.4
Electrical	Power Input	kW	0.036
	Run Current	Amps	0.38
	Start Current	Amps	0.42

### Indoor Data

Airflow	High - Medium - Low	l/s	358 - 255 - 222
	High - Medium - Low	m3/h	1290 - 920 - 800
Sound	Pressure High - Medium - Low	dB(A)	35 - 31 - 28
	Power High - Medium - Low	dB(A)	50 - 46 - 43
Unit	Height x Width x Depth	mm	256 x 840 x 840
	Weight	kg	20
Panel	Height x Width x Depth	mm	30 x 950 x 950
	Weight RBC-U32PGP-E	kg	4
Pipe Connection	Flare Connections (gas - liquid)	inch	5/8 - 3/8
	Drain Pipe Connection OD/ID	mm	32/25
Power Supply	Suggested Fuse Size	V/ph/Hz-A	220-240/1/50-5

### Accessories

<a href="#">RBC-AMTU31-E</a>	Standard Remote Controller - Full control including service functions
<a href="#">RBC-ASCU11-E</a>	Compact Remote Controller - Includes timer off, back light display, multilingual
<a href="#">RBC-AWSU52-E</a>	Premium Controller - Includes timer and back light display, multilingual (inc. Bluetooth)
<a href="#">RBC-MTSC1</a>	Mini Touch Screen Controller - with configurable icons for indoor units
<a href="#">RBC-MTSC2</a>	Mini Touch Screen Controller - with Schedule Timer, configurable icons for indoor units
<a href="#">TCB-GFC1603U-E</a>	Fresh Air Chamber - Fresh Air chamber for use with TCB-GB1602UE
<a href="#">TCB-BC1602UE</a>	Air discharge direction kit - Air Discharge kit - With 6-direction patterns
<a href="#">TCB-FF101URE2</a>	Auxiliary fresh air flange - For easy fresh air intake by using knock out hole of indoor.

\*All [Accessories](#) / [Controls](#)

Compatible R410a outdoor condensers:

[Mini SMMS-e](#), [SMMS-u](#), [SHRM-e](#)

Compatible R32 outdoor condensers:

[Mini SMMS](#), [SHRM-a](#)

Related items:

- [Full specification](#)
- [BIM files](#)
- [Airflow/ fan curve](#)
- [Dimensional drawing](#)
- [Wiring diagram](#)
- [Noise curve data](#)
- [Installation manual](#)

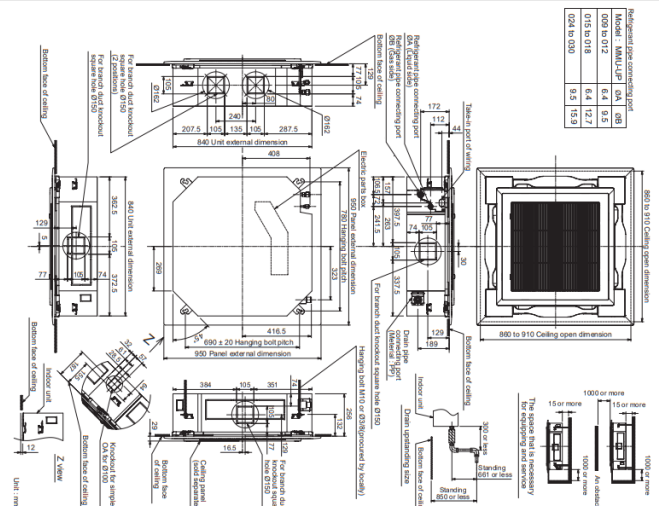



## VRF 4-WAY STANDARD CASSETTE: MMU - UP0271HP-E

- Possible to set three different swing modes.
- Optimal air diffusion up to 4.6m ceiling height.
- Lightweight unit, for easy and quick installation.
- Compact chassis with only 256mm height (up to size 30).
- Self-cleaning function and Ag-ion tip for anti-mould in drain cap.



Hi - Res Image



### Performance Data

Capacity Code		HP	3.0
Nominal	Cooling Capacity	kW	8.0
	Heating Capacity	kW	9.0
UK	Cooling Total/Sensible	kW	7.3/5.2
	Heating	kW	6.1
Electrical	Power Input	kW	0.036
	Run Current	Amps	0.38
	Start Current	Amps	0.42

### Indoor Data

Airflow	High - Medium - Low	l/s	358 - 255 - 222
	High - Medium - Low	m3/h	1290 - 920 - 800
Sound	Pressure High - Medium - Low	dB(A)	35 - 31 - 28
	Power High - Medium - Low	dB(A)	50 - 46 - 43
Unit	Height x Width x Depth	mm	256 x 840 x 840
	Weight	kg	20
Panel	Height x Width x Depth	mm	30 x 950 x 950
	Weight RBC-U32PGP-E	kg	4
Pipe Connection	Flare Connections (gas - liquid)	inch	5/8 - 3/8
	Drain Pipe Connection OD/ID	mm	32/25
Power Supply	Suggested Fuse Size	V/ph/Hz-A	220-240/1/50-5

### Accessories

<a href="#">RBC-AMTU31-E</a>	Standard Remote Controller - Full control including service functions
<a href="#">RBC-ASCU11-E</a>	Compact Remote Controller - Includes timer off, back light display, multilingual
<a href="#">RBC-AWSU52-E</a>	Premium Controller - Includes timer and back light display, multilingual (inc. Bluetooth)
<a href="#">RBC-MTSC1</a>	Mini Touch Screen Controller - with configurable icons for indoor units
<a href="#">RBC-MTSC2</a>	Mini Touch Screen Controller - with Schedule Timer, configurable icons for indoor units
<a href="#">TCB-GFC1603U-E</a>	Fresh Air Chamber - Fresh Air chamber for use with TCB-GB1602UE
<a href="#">TCB-BC1602UE</a>	Air discharge direction kit - Air Discharge kit - With 6-direction patterns
<a href="#">TCB-FF101URE2</a>	Auxiliary fresh air flange - For easy fresh air intake by using knock out hole of indoor.

\*All [Accessories](#) / [Controls](#)

Compatible R410a outdoor condensers:

[Mini SMMS-e](#), [SMMS-u](#), [SHRM-e](#)

Compatible R32 outdoor condensers:

[Mini SMMS](#), [SHRM-a](#)

Related items:

- [Full specification](#)
- [BIM files](#)
- [Airflow/ fan curve](#)
- [Dimensional drawing](#)
- [Wiring diagram](#)
- [Noise curve data](#)
- [Installation manual](#)

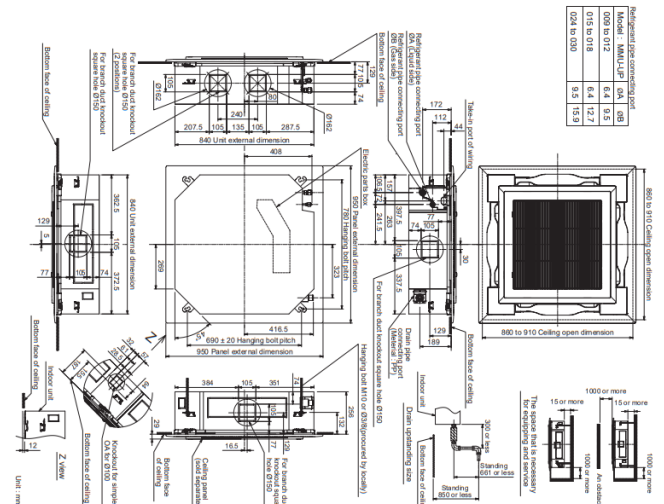

Standard remote controller (RBC)	1.41
Compact remote controller (RBC)	1.41
Premium remote controller (RBC)	1.41
Mini touch screen controller (RBC)	1.41
Mini touch screen controller (RBC)	1.41
Fresh air chamber (TCB)	1.41
Air discharge direction kit (TCB)	1.41
Auxiliary fresh air flange (TCB)	1.41

## VRF 4-WAY STANDARD CASSETTE: MMU - UPO301HP-E

- Possible to set three different swing modes.
- Optimal air diffusion up to 4.6m ceiling height.
- Lightweight unit, for easy and quick installation.
- Compact chassis with only 256mm height (up to size 30).
- Self-cleaning function and Ag-ion tip for anti-mould in drain cap.



Hi - Res Image

### Performance Data

Capacity Code		HP	3.2
Nominal	Cooling Capacity	kW	9.0
	Heating Capacity	kW	10.0
UK	Cooling Total/Sensible	kW	8.2/5.9
	Heating	kW	6.8
Electrical	Power Input	kW	0.043
	Run Current	Amps	0.43
	Start Current	Amps	0.59

### Indoor Data

Airflow	High - Medium - Low	l/s	367 - 305 - 237
	High - Medium - Low	m3/h	1320 - 1100 - 850
Sound	Pressure High - Medium - Low	dB(A)	38 - 33 - 30
	Power High - Medium - Low	dB(A)	53 - 48 - 45
Unit	Height x Width x Depth	mm	256 x 840 x 840
	Weight	kg	20
Panel	Height x Width x Depth	mm	30 x 950 x 950
	Weight RBC-U32PGP-E	kg	4
Pipe Connection	Flare Connections (gas - liquid)	inch	5/8 - 3/8
	Drain Pipe Connection OD/ID	mm	32/25
Power Supply	Suggested Fuse Size	V/ph/Hz-A	220-240/1/50-5

### Accessories

<a href="#">RBC-AMTU31-E</a>	Standard Remote Controller - Full control including service functions
<a href="#">RBC-ASCU11-E</a>	Compact Remote Controller - Includes timer off, back light display, multilingual
<a href="#">RBC-AWSU52-E</a>	Premium Controller - Includes timer and back light display, multilingual (inc. Bluetooth)
<a href="#">RBC-MTSC1</a>	Mini Touch Screen Controller - with configurable icons for indoor units
<a href="#">RBC-MTSC2</a>	Mini Touch Screen Controller - with Schedule Timer, configurable icons for indoor units
<a href="#">TCB-GFC1603U-E</a>	Fresh Air Chamber - Fresh Air chamber for use with TCB-GB1602UE
<a href="#">TCB-BC1602UE</a>	Air discharge direction kit - Air Discharge kit - With 6-direction patterns
<a href="#">TCB-FF101URE2</a>	Auxiliary fresh air flange - For easy fresh air intake by using knock out hole of indoor.

\*All [Accessories](#) / [Controls](#)

Compatible R410a outdoor condensers:

[Mini SMMS-e](#), [SMMS-u](#), [SHRM-e](#)

Compatible R32 outdoor condensers:

[Mini SMMS](#), [SHRM-a](#)

Related items:

- [Full specification](#)
- [BIM files](#)
- [Airflow/ fan curve](#)
- [Dimensional drawing](#)
- [Wiring diagram](#)
- [Noise curve data](#)
- [Installation manual](#)

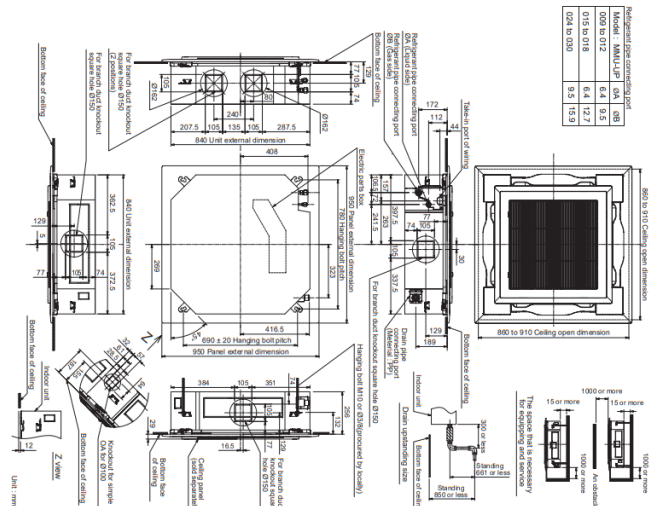

## VRF 4-WAY STANDARD CASSETTE: MMU - UP0361HP-E

- Possible to set three different swing modes.
- Optimal air diffusion up to 4.6m ceiling height.
- Lightweight unit, for easy and quick installation.
- Compact chassis with only 319mm height (up to size 56).
- Self-cleaning function and Ag-ion tip for anti-mould in drain cap.



Hi - Res Image 



### Performance Data

Capacity Code		HP	4.0
Nominal	Cooling Capacity	kW	11.2
	Heating Capacity	kW	12.5
UK	Cooling Total/Sensible	kW	10.2/7.3
	Heating	kW	8.5
Electrical	Power Input	kW	0.088
	Run Current	Amps	0.78
	Start Current	Amps	0.87

### Indoor Data

Airflow	High - Medium - Low	l/s	547 - 397 - 297
	High - Medium - Low	m3/h	1970 - 1430 - 1070
Sound	Pressure High - Medium - Low	dB(A)	43 - 38 - 32
	Power High - Medium - Low	dB(A)	58 - 53 - 47
Unit	Height x Width x Depth	mm	319 x 840 x 840
	Weight	kg	25
Panel	Height x Width x Depth	mm	30 x 950 x 950
	Weight RBC-U32PGP-E	kg	4
Pipe Connection	Flare Connections (gas - liquid)	inch	5/8 - 3/8
	Drain Pipe Connection OD/ID	mm	32/25
Power Supply	Suggested Fuse Size	V/ph/Hz-A	220-240/1/50-5

### Accessories

<a href="#">RBC-AMTU31-E</a>	Standard Remote Controller - Full control including service functions
<a href="#">RBC-ASCU11-E</a>	Compact Remote Controller - Includes timer off, back light display, multilingual
<a href="#">RBC-AWSU52-E</a>	Premium Controller - Includes timer and back light display, multilingual (inc. Bluetooth)
<a href="#">RBC-MTSC1</a>	Mini Touch Screen Controller - with configurable icons for indoor units
<a href="#">RBC-MTSC2</a>	Mini Touch Screen Controller - with Schedule Timer, configurable icons for indoor units
<a href="#">TCB-GFC1603U-E</a>	Fresh Air Chamber - Fresh Air chamber for use with TCB-GB1602UE
<a href="#">TCB-BC1602UE</a>	Air discharge direction kit - Air Discharge kit - With 6-direction patterns
<a href="#">TCB-FF101URE2</a>	Auxiliary fresh air flange - For easy fresh air intake by using knock out hole of indoor.

\*All [Accessories](#) / [Controls](#)

Compatible R410a outdoor condensers:

[Mini SMMS-e](#), [SMMS-u](#), [SHRM-e](#)

Compatible R32 outdoor condensers:

[Mini SMMS](#), [SHRM-a](#)

Related items:

- [Full specification](#)
- [BIM files](#)
- [Airflow/ fan curve](#)
- [Dimensional drawing](#)
- [Wiring diagram](#)
- [Noise curve data](#)
- [Installation manual](#)

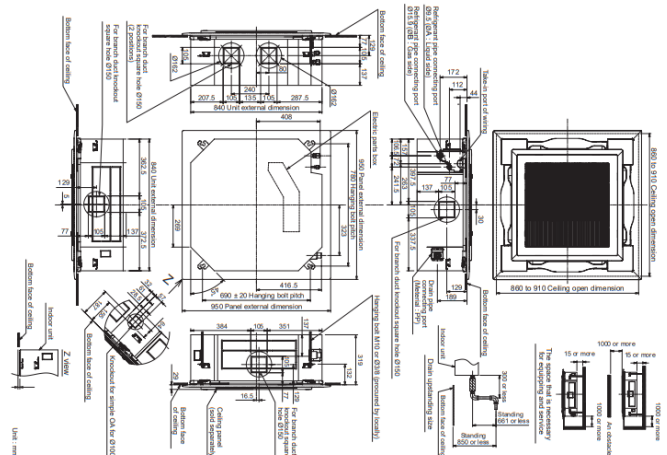

## VRF 4-WAY STANDARD CASSETTE: MMU - UPO481HP-E

- Possible to set three different swing modes.
- Optimal air diffusion up to 4.6m ceiling height.
- Lightweight unit, for easy and quick installation.
- Compact chassis with only 319mm height (up to size 56).
- Self-cleaning function and Ag-ion tip for anti-mould in drain cap.



Hi - Res Image 



### Performance Data

Capacity Code		HP	5.0
Nominal	Cooling Capacity	kW	14.0
	Heating Capacity	kW	16.0
UK	Cooling Total/Sensible	kW	12.7/9.3
	Heating	kW	10.9
Electrical	Power Input	kW	0.112
	Run Current	Amps	0.88
	Start Current	Amps	1.23

### Indoor Data

Airflow	High - Medium - Low	l/s	592 - 397 - 313
	High - Medium - Low	m3/h	2130 - 1430 - 1130
Sound	Pressure High - Medium - Low	dB(A)	46 - 38 - 33
	Power High - Medium - Low	dB(A)	61 - 53 - 48
Unit	Height x Width x Depth	mm	319 x 840 x 840
	Weight	kg	25
Panel	Height x Width x Depth	mm	30 x 950 x 950
	Weight RBC-U32PGP-E	kg	4
Pipe Connection	Flare Connections (gas - liquid)	inch	5/8 - 3/8
	Drain Pipe Connection OD/ID	mm	32/25
Power Supply	Suggested Fuse Size	V/ph/Hz-A	220-240/1/50-5

### Accessories

<a href="#">RBC-AMTU31-E</a>	Standard Remote Controller - Full control including service functions
<a href="#">RBC-ASCU11-E</a>	Compact Remote Controller - Includes timer off, back light display, multilingual
<a href="#">RBC-AWSU52-E</a>	Premium Controller - Includes timer and back light display, multilingual (inc. Bluetooth)
<a href="#">RBC-MTSC1</a>	Mini Touch Screen Controller - with configurable icons for indoor units
<a href="#">RBC-MTSC2</a>	Mini Touch Screen Controller - with Schedule Timer, configurable icons for indoor units
<a href="#">TCB-GFC1603U-E</a>	Fresh Air Chamber - Fresh Air chamber for use with TCB-GB1602UE
<a href="#">TCB-BC1602UE</a>	Air discharge direction kit - Air Discharge kit - With 6-direction patterns
<a href="#">TCB-FF101URE2</a>	Auxiliary fresh air flange - For easy fresh air intake by using knock out hole of indoor.

\*All [Accessories / Controls](#)

Compatible R410a outdoor condensers:

[Mini SMMS-e](#), [SMMS-u](#), [SHRM-e](#)

Compatible R32 outdoor condensers:

[Mini SMMS](#), [SHRM-a](#)

Related items:

- [Full specification](#)
- [BIM files](#)
- [Airflow/ fan curve](#)
- [Dimensional drawing](#)
- [Wiring diagram](#)
- [Noise curve data](#)
- [Installation manual](#)

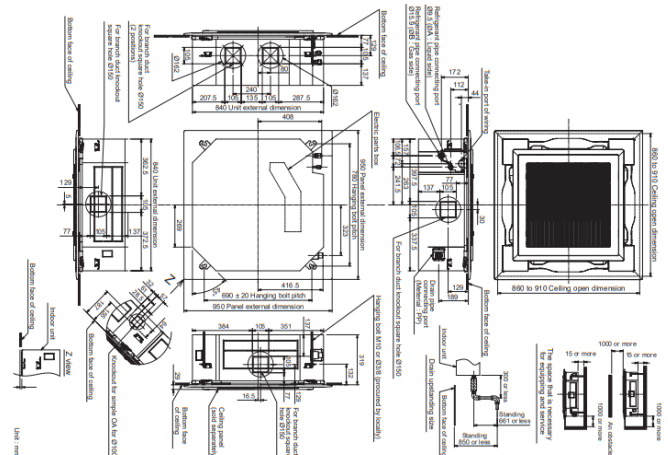

## VRF 4-WAY STANDARD CASSETTE: MMU - UP0561HP-E

- Possible to set three different swing modes.
- Optimal air diffusion up to 4.6m ceiling height.
- Lightweight unit, for easy and quick installation.
- Compact chassis with only 319mm height (up to size 56).
- Self-cleaning function and Ag-ion tip for anti-mould in drain cap.



Hi - Res Image 



### Performance Data

Capacity Code		HP	6.0
Nominal	Cooling Capacity	kW	16.0
	Heating Capacity	kW	18.0
UK	Cooling Total/Sensible	kW	14.5/10.4
	Heating	kW	12.2
Electrical	Power Input	kW	0.112
	Run Current	Amps	0.88
	Start Current	Amps	1.26

### Indoor Data

Airflow	High - Medium - Low	l/s	592 - 422 - 342
	High - Medium - Low	m3/h	2130 - 1520 - 1230
Sound	Pressure High - Medium - Low	dB(A)	46 - 40 - 33
	Power High - Medium - Low	dB(A)	61 - 55 - 48
Unit	Height x Width x Depth	mm	319 x 840 x 840
	Weight	kg	25
Panel	Height x Width x Depth	mm	30 x 950 x 950
	Weight RBC-U32PGP-E	kg	4
Pipe Connection	Flare Connections (gas - liquid)	inch	5/8 - 3/8
	Drain Pipe Connection OD/ID	mm	32/25
Power Supply	Suggested Fuse Size	V/ph/Hz-A	220-240/1/50-5

### Accessories

<a href="#">RBC-AMTU31-E</a>	Standard Remote Controller - Full control including service functions
<a href="#">RBC-ASCU11-E</a>	Compact Remote Controller - Includes timer off, back light display, multilingual
<a href="#">RBC-AWSU52-E</a>	Premium Controller - Includes timer and back light display, multilingual (inc. Bluetooth)
<a href="#">RBC-MTSC1</a>	Mini Touch Screen Controller - with configurable icons for indoor units
<a href="#">RBC-MTSC2</a>	Mini Touch Screen Controller - with Schedule Timer, configurable icons for indoor units
<a href="#">TCB-GFC1603U-E</a>	Fresh Air Chamber - Fresh Air chamber for use with TCB-GB1602UE
<a href="#">TCB-BC1602UE</a>	Air discharge direction kit - Air Discharge kit - With 6-direction patterns
<a href="#">TCB-FF101URE2</a>	Auxiliary fresh air flange - For easy fresh air intake by using knock out hole of indoor.

\*All [Accessories](#) / [Controls](#)

Compatible R410a outdoor condensers:

[Mini SMMS-e](#), [SMMS-u](#), [SHRM-e](#)

Compatible R32 outdoor condensers:

[Mini SMMS](#), [SHRM-a](#)

Related items:

- [Full specification](#)
- [BIM files](#)
- [Airflow/ fan curve](#)
- [Dimensional drawing](#)
- [Wiring diagram](#)
- [Noise curve data](#)
- [Installation manual](#)

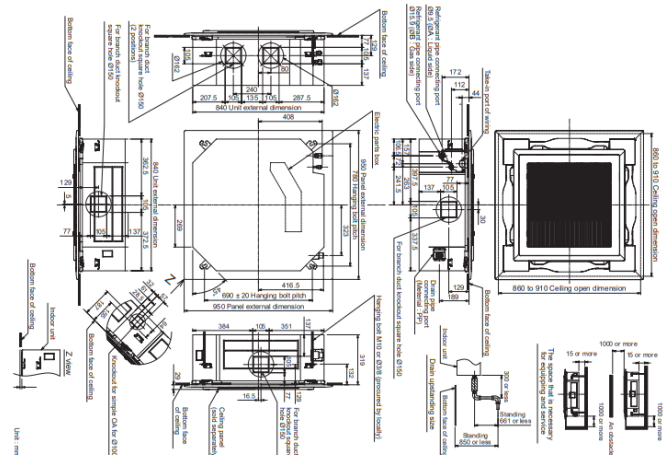

# 4-Way Smart Cassette



## VRF 4-WAY SMART CASSETTE: MMU - UP0091H-E

- Simple & elegant design fits various rooms.
- 5 fan steps to precisely control the air flow.
- Unique louvre design for optimal air distribution.
- Top class SEER and SCOP, thanks to long split heat exchanger with magic coil treatment.
- Energy saving with the occupancy sensor, automatically switch off the unit if nobody is in the room.



Hi - Res Image 



### Performance Data

Capacity Code		HP	1.0
Nominal	Cooling Capacity	kW	2.8
	Heating Capacity	kW	3.2
UK	Cooling Total/Sensible	kW	2.5/2.0
	Heating	kW	2.2
Electrical	Power Input	kW	0.020
	Run Current	Amps	0.18
	Start Current	Amps	0.27

### Indoor Data

Airflow	High - Medium - Low	l/s	235 - 213 - 197
	High - Medium - Low	m3/h	846 - 768 - 708
Sound	Pressure High - Medium - Low	dB(A)	30 - 28 - 26
	Power High - Medium - Low	dB(A)	45 - 43 - 42
Unit	Height x Width x Depth	mm	256 x 840 x 840
	Weight	kg	18
Panel	Height x Width x Depth	mm	30 x 950 x 950
	Weight RBC-U41PG(W)-E	kg	5
Pipe Connection	Flare Connections (gas - liquid)	inch	3/8 - 1/4
	Drain Pipe Connection OD/ID	mm	32/25
Power Supply	Suggested Fuse Size	V/ph/Hz-A	220-240/1/50-5

### Accessories

<a href="#">RBC-AMTU31-E</a>	Standard Remote Controller - Full control including service functions
<a href="#">RBC-ASCU11-E</a>	Compact Remote Controller - Includes timer off, back light display, multilingual
<a href="#">RBC-AWSU52-E</a>	Premium Controller - Includes timer and back light display, multilingual (inc. Bluetooth)
<a href="#">RBC-MTSC1</a>	Mini Touch Screen Controller - with configurable icons for indoor units
<a href="#">RBC-MTSC2</a>	Mini Touch Screen Controller - with Schedule Timer, configurable icons for indoor units
<a href="#">TCB-SIR41U-E</a>	Occupancy sensor - Cannot be used with wireless remote control kit.
<a href="#">RBC-AXU41U-E</a>	Wireless remote kit - Cannot be used with Occupancy sensor
<a href="#">TCB-FF101URE2</a>	Auxiliary fresh air flange - For easy fresh air intake by using knock out hole of indoor.

\*All [Accessories](#) / [Controls](#)

Compatible R410a outdoor condensers:

[Mini SMMS-e](#), [SMMS-u](#), [SHRM-e](#)

Compatible R32 outdoor condensers:

[Mini SMMS](#), [SHRM-a](#)

Related items:

- [Full specification](#)
- [Airflow/ fan curve](#)
- [Dimensional drawing](#)
- [Wiring diagram](#)
- [Noise curve data](#)
- [Installation manual](#)

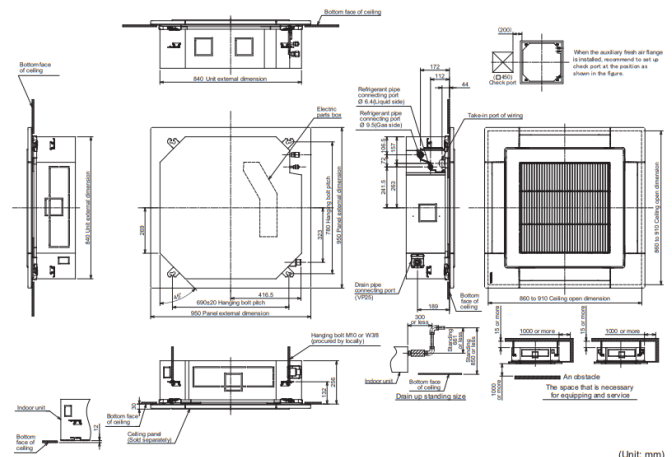

(Unit: mm)

## VRF 4-WAY SMART CASSETTE: MMU - UP0121H-E

- Simple & elegant design fits various rooms.
- 5 fan steps to precisely control the air flow.
- Unique louvre design for optimal air distribution.
- Top class SEER and SCOP, thanks to long split heat exchanger with magic coil treatment.
- Energy saving with the occupancy sensor, automatically switch off the unit if nobody is in the room.



Hi - Res Image



### Performance Data

Capacity Code		HP	1.3
Nominal	Cooling Capacity	kW	3.6
	Heating Capacity	kW	4.0
UK	Cooling Total/Sensible	kW	3.3/2.5
	Heating	kW	2.7
Electrical	Power Input	kW	0.020
	Run Current	Amps	0.18
	Start Current	Amps	0.27

### Indoor Data

Airflow	High - Medium - Low	l/s	235 - 213 - 197
	High - Medium - Low	m3/h	846 - 768 - 708
Sound	Pressure High - Medium - Low	dB(A)	30 - 28 - 26
	Power High - Medium - Low	dB(A)	45 - 43 - 42
Unit	Height x Width x Depth	mm	256 x 840 x 840
	Weight	kg	18
Panel	Height x Width x Depth	mm	30 x 950 x 950
	Weight RBC-U41PG(W)-E	kg	5
Pipe Connection	Flare Connections (gas - liquid)	inch	3/8 - 1/4
	Drain Pipe Connection OD/ID	mm	32/25
Power Supply	Suggested Fuse Size	V/ph/Hz-A	220-240/1/50-5

### Accessories

<a href="#">RBC-AMTU31-E</a>	Standard Remote Controller - Full control including service functions
<a href="#">RBC-ASCU11-E</a>	Compact Remote Controller - Includes timer off, back light display, multilingual
<a href="#">RBC-AWSU52-E</a>	Premium Controller - Includes timer and back light display, multilingual (inc. Bluetooth)
<a href="#">RBC-MTSC1</a>	Mini Touch Screen Controller - with configurable icons for indoor units
<a href="#">RBC-MTSC2</a>	Mini Touch Screen Controller - with Schedule Timer, configurable icons for indoor units
<a href="#">TCB-SIR41U-E</a>	Occupancy sensor - Cannot be used with wireless remote control kit.
<a href="#">RBC-AXU41U-E</a>	Wireless remote kit - Cannot be used with Occupancy sensor
<a href="#">TCB-FF101URE2</a>	Auxiliary fresh air flange - For easy fresh air intake by using knock out hole of indoor.

\*All [Accessories](#) / [Controls](#)

Compatible R410a outdoor condensers:

[Mini SMMS-e](#), [SMMS-u](#), [SHRM-e](#)

Compatible R32 outdoor condensers:

[Mini SMMS](#), [SHRM-a](#)

Related items:

- [Full specification](#)
- [Airflow/ fan curve](#)
- [Dimensional drawing](#)
- [Wiring diagram](#)
- [Noise curve data](#)
- [Installation manual](#)

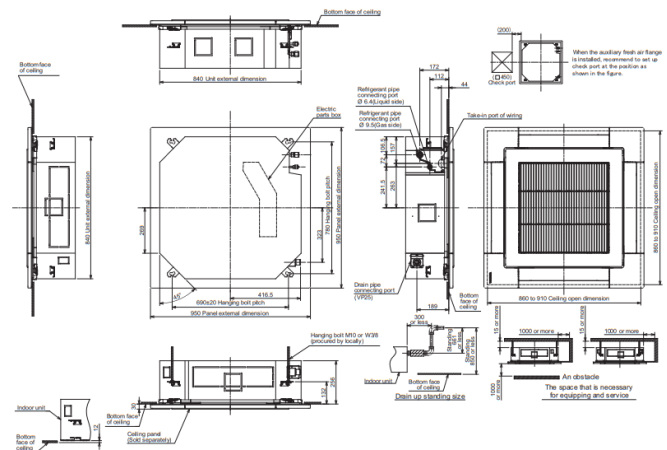

(Unit: mm)



## VRF 4-WAY SMART CASSETTE: MMU - UP0151H-E

- Simple & elegant design fits various rooms.
- 5 fan steps to precisely control the air flow.
- Unique louvre design for optimal air distribution.
- Top class SEER and SCOP, thanks to long split heat exchanger with magic coil treatment.
- Energy saving with the occupancy sensor, automatically switch off the unit if nobody is in the room.



Hi - Res Image 



### Performance Data

Capacity Code		HP	1.7
Nominal	Cooling Capacity	kW	4.5
	Heating Capacity	kW	5.0
UK	Cooling Total/Sensible	kW	4.1/3.0
	Heating	kW	3.4
Electrical	Power Input	kW	0.018
	Run Current	Amps	0.2
	Start Current	Amps	0.3

### Indoor Data

Airflow	High - Medium - Low	l/s	294 - 256 - 222
	High - Medium - Low	m3/h	1060 - 920 - 800
Sound	Pressure High - Medium - Low	dB(A)	32 - 30 - 28
	Power High - Medium - Low	dB(A)	46 - 44 - 42
Unit	Height x Width x Depth	mm	319 x 840 x 840
	Weight	kg	25
Panel	Height x Width x Depth	mm	30 x 950 x 950
	Weight RBC-U41PG(W)-E	kg	5
Pipe Connection	Flare Connections (gas - liquid)	inch	1/2 - 1/4
	Drain Pipe Connection OD/ID	mm	32/25
Power Supply	Suggested Fuse Size	V/ph/Hz-A	220-240/1/50-5

### Accessories

<a href="#">RBC-AMTU31-E</a>	Standard Remote Controller - Full control including service functions
<a href="#">RBC-ASCU11-E</a>	Compact Remote Controller - Includes timer off, back light display, multilingual
<a href="#">RBC-AWSU52-E</a>	Premium Controller - Includes timer and back light display, multilingual (inc. Bluetooth)
<a href="#">RBC-MTSC1</a>	Mini Touch Screen Controller - with configurable icons for indoor units
<a href="#">RBC-MTSC2</a>	Mini Touch Screen Controller - with Schedule Timer, configurable icons for indoor units
<a href="#">TCB-SIR41U-E</a>	Occupancy sensor - Cannot be used with wireless remote control kit.
<a href="#">RBC-AXU41U-E</a>	Wireless remote kit - Cannot be used with Occupancy sensor
<a href="#">TCB-FF101URE2</a>	Auxiliary fresh air flange - For easy fresh air intake by using knock out hole of indoor.

\*All [Accessories](#) / [Controls](#)

Compatible R410a outdoor condensers:

[Mini SMMS-e](#), [SMMS-u](#), [SHRM-e](#)

Compatible R32 outdoor condensers:

[Mini SMMS](#), [SHRM-a](#)

Related items:

- [Full specification](#)
- [Airflow/ fan curve](#)
- [Dimensional drawing](#)
- [Wiring diagram](#)
- [Noise curve data](#)
- [Installation manual](#)

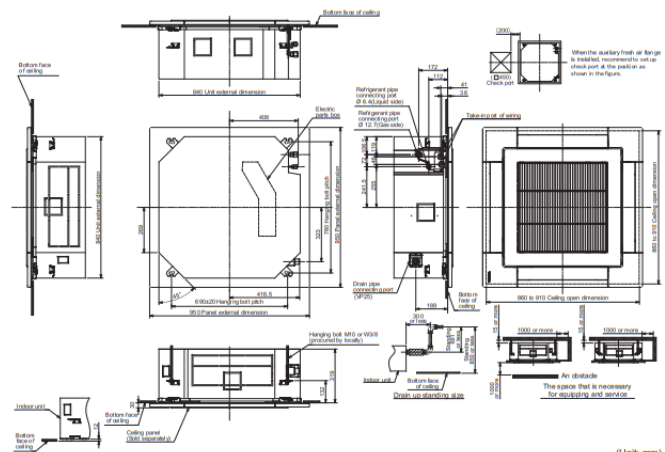

(Unit: mm)

## VRF 4-WAY SMART CASSETTE: MMU - UP0181H-E

- Simple & elegant design fits various rooms.
- 5 fan steps to precisely control the air flow.
- Unique louvre design for optimal air distribution.
- Top class SEER and SCOP, thanks to long split heat exchanger with magic coil treatment.
- Energy saving with the occupancy sensor, automatically switch off the unit if nobody is in the room.



Hi - Res Image



### Performance Data

Capacity Code		HP	2.0
Nominal	Cooling Capacity	kW	5.6
	Heating Capacity	kW	6.3
UK	Cooling Total/Sensible	kW	5.1/3.8
	Heating	kW	4.3
Electrical	Power Input	kW	0.026
	Run Current	Amps	0.26
	Start Current	Amps	0.39

### Indoor Data

Airflow	High - Medium - Low	l/s	350 - 306 - 261
	High - Medium - Low	m3/h	1260 - 1100 - 940
Sound	Pressure High - Medium - Low	dB(A)	36 - 33 - 31
	Power High - Medium - Low	dB(A)	50 - 47 - 45
Unit	Height x Width x Depth	mm	319 x 840 x 840
	Weight	kg	25
Panel	Height x Width x Depth	mm	30 x 950 x 950
	Weight RBC-U41PG(W)-E	kg	5
Pipe Connection	Flare Connections (gas - liquid)	inch	1/2 - 1/4
	Drain Pipe Connection OD/ID	mm	32/25
Power Supply	Suggested Fuse Size	V/ph/Hz-A	220-240/1/50-5

### Accessories

<a href="#">RBC-AMTU31-E</a>	Standard Remote Controller - Full control including service functions
<a href="#">RBC-ASCU11-E</a>	Compact Remote Controller - Includes timer off, back light display, multilingual
<a href="#">RBC-AWSU52-E</a>	Premium Controller - Includes timer and back light display, multilingual (inc. Bluetooth)
<a href="#">RBC-MTSC1</a>	Mini Touch Screen Controller - with configurable icons for indoor units
<a href="#">RBC-MTSC2</a>	Mini Touch Screen Controller - with Schedule Timer, configurable icons for indoor units
<a href="#">TCB-SIR41U-E</a>	Occupancy sensor - Cannot be used with wireless remote control kit.
<a href="#">RBC-AXU41U-E</a>	Wireless remote kit - Cannot be used with Occupancy sensor
<a href="#">TCB-FF101URE2</a>	Auxiliary fresh air flange - For easy fresh air intake by using knock out hole of indoor.

\*All [Accessories](#) / [Controls](#)

Compatible R410a outdoor condensers:

[Mini SMMS-e](#), [SMMS-u](#), [SHRM-e](#)

Compatible R32 outdoor condensers:

[Mini SMMS](#), [SHRM-a](#)

Related items:

- [Full specification](#)
- [Airflow/ fan curve](#)
- [Dimensional drawing](#)
- [Wiring diagram](#)
- [Noise curve data](#)
- [Installation manual](#)

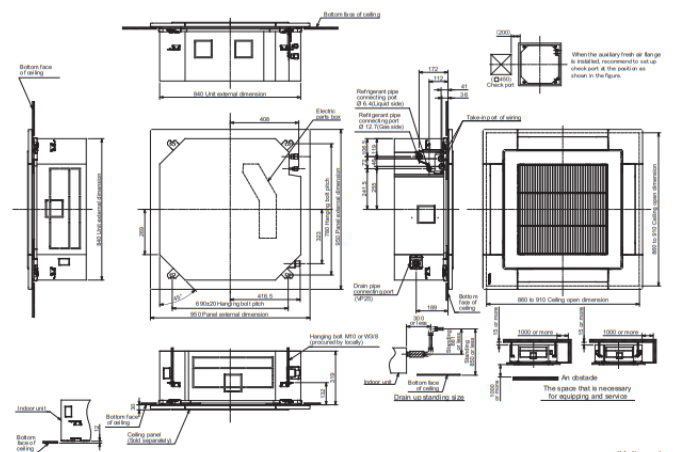

(Unit: mm)

## VRF 4-WAY SMART CASSETTE: MMU - UP0241H-E

- Simple & elegant design fits various rooms.
- 5 fan steps to precisely control the air flow.
- Unique louvre design for optimal air distribution.
- Top class SEER and SCOP, thanks to long split heat exchanger with magic coil treatment.
- Energy saving with the occupancy sensor, automatically switch off the unit if nobody is in the room.



Hi - Res Image 



### Performance Data

Capacity Code		HP	2.5
Nominal	Cooling Capacity	kW	7.1
	Heating Capacity	kW	8.0
UK	Cooling Total/Sensible	kW	6.4/4.6
	Heating	kW	5.4
Electrical	Power Input	kW	0.042
	Run Current	Amps	0.38
	Start Current	Amps	0.57

### Indoor Data

Airflow	High - Medium - Low	l/s	439 - 361 - 311
	High - Medium - Low	m3/h	1580 - 1300 - 1120
Sound	Pressure High - Medium - Low	dB(A)	41 - 37 - 35
	Power High - Medium - Low	dB(A)	55 - 51 - 48
Unit	Height x Width x Depth	mm	319 x 840 x 840
	Weight	kg	25
Panel	Height x Width x Depth	mm	30 x 950 x 950
	Weight RBC-U41PG(W)-E	kg	5
Pipe Connection	Flare Connections (gas - liquid)	inch	5/8 - 3/8
	Drain Pipe Connection OD/ID	mm	32/25
Power Supply	Suggested Fuse Size	V/ph/Hz-A	220-240/1/50-5

### Accessories

<a href="#">RBC-AMTU31-E</a>	Standard Remote Controller - Full control including service functions
<a href="#">RBC-ASCU11-E</a>	Compact Remote Controller - Includes timer off, back light display, multilingual
<a href="#">RBC-AWSU52-E</a>	Premium Controller - Includes timer and back light display, multilingual (inc. Bluetooth)
<a href="#">RBC-MTSC1</a>	Mini Touch Screen Controller - with configurable icons for indoor units
<a href="#">RBC-MTSC2</a>	Mini Touch Screen Controller - with Schedule Timer, configurable icons for indoor units
<a href="#">TCB-SIR41U-E</a>	Occupancy sensor - Cannot be used with wireless remote control kit.
<a href="#">RBC-AXU41U-E</a>	Wireless remote kit - Cannot be used with Occupancy sensor
<a href="#">TCB-FF101URE2</a>	Auxiliary fresh air flange - For easy fresh air intake by using knock out hole of indoor.

\*All [Accessories](#) / [Controls](#)

Compatible R410a outdoor condensers:

[Mini SMMS-e](#), [SMMS-u](#), [SHRM-e](#)

Compatible R32 outdoor condensers:

[Mini SMMS](#), [SHRM-a](#)

Related items:

- [Full specification](#)
- [Airflow/ fan curve](#)
- [Dimensional drawing](#)
- [Wiring diagram](#)
- [Noise curve data](#)
- [Installation manual](#)

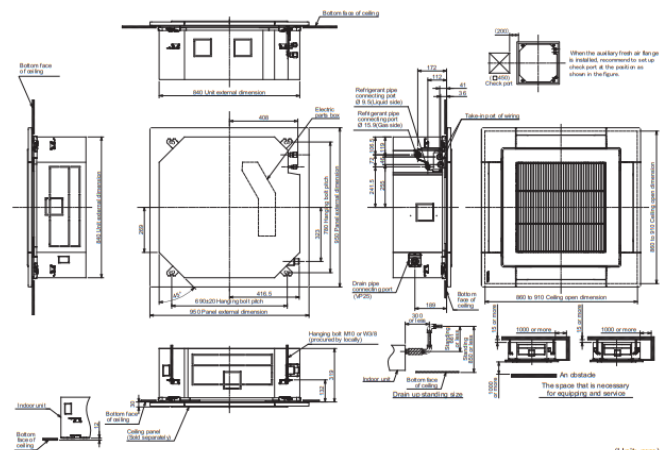

(Unit: mm)

## VRF 4-WAY SMART CASSETTE: MMU - UP0271H-E

- Simple & elegant design fits various rooms.
- 5 fan steps to precisely control the air flow.
- Unique louvre design for optimal air distribution.
- Top class SEER and SCOP, thanks to long split heat exchanger with magic coil treatment.
- Energy saving with the occupancy sensor, automatically switch off the unit if nobody is in the room.



Hi - Res Image



### Performance Data

Capacity Code		HP	3.0
Nominal	Cooling Capacity	kW	8.0
	Heating Capacity	kW	9.0
UK	Cooling Total/Sensible	kW	7.3/5.2
	Heating	kW	6.1
Electrical	Power Input	kW	0.054
	Run Current	Amps	0.48
	Start Current	Amps	0.72

### Indoor Data

Airflow	High - Medium - Low	l/s	492 - 383 - 347
	High - Medium - Low	m3/h	1770 - 1380 - 1250
Sound	Pressure High - Medium - Low	dB(A)	42 - 37 - 35
	Power High - Medium - Low	dB(A)	56 - 51 - 49
Unit	Height x Width x Depth	mm	319 x 840 x 840
	Weight	kg	25
Panel	Height x Width x Depth	mm	30 x 950 x 950
	Weight RBC-U41PG(W)-E	kg	5
Pipe Connection	Flare Connections (gas - liquid)	inch	5/8 - 3/8
	Drain Pipe Connection OD/ID	mm	32/25
Power Supply	Suggested Fuse Size	V/ph/Hz-A	220-240/1/50-5

### Accessories

<a href="#">RBC-AMTU31-E</a>	Standard Remote Controller - Full control including service functions
<a href="#">RBC-ASCU11-E</a>	Compact Remote Controller - Includes timer off, back light display, multilingual
<a href="#">RBC-AWSU52-E</a>	Premium Controller - Includes timer and back light display, multilingual (inc. Bluetooth)
<a href="#">RBC-MTSC1</a>	Mini Touch Screen Controller - with configurable icons for indoor units
<a href="#">RBC-MTSC2</a>	Mini Touch Screen Controller - with Schedule Timer, configurable icons for indoor units
<a href="#">TCB-SIR41U-E</a>	Occupancy sensor - Cannot be used with wireless remote control kit.
<a href="#">RBC-AXU41U-E</a>	Wireless remote kit - Cannot be used with Occupancy sensor
<a href="#">TCB-FF101URE2</a>	Auxiliary fresh air flange - For easy fresh air intake by using knock out hole of indoor.

\*All [Accessories](#) / [Controls](#)

Compatible R410a outdoor condensers:

[Mini SMMS-e](#), [SMMS-u](#), [SHRM-e](#)

Compatible R32 outdoor condensers:

[Mini SMMS](#), [SHRM-a](#)

Related items:

- [Full specification](#)
- [Airflow/ fan curve](#)
- [Dimensional drawing](#)
- [Wiring diagram](#)
- [Noise curve data](#)
- [Installation manual](#)

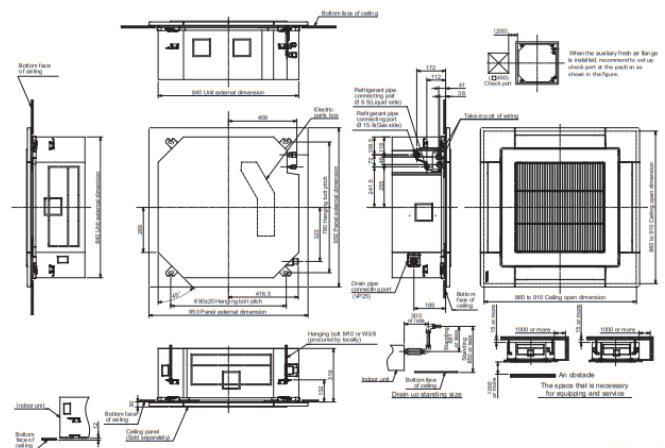

(Unit: mm)

## VRF 4-WAY SMART CASSETTE: MMU - UP0301H-E

- Simple & elegant design fits various rooms.
- 5 fan steps to precisely control the air flow.
- Unique louvre design for optimal air distribution.
- Top class SEER and SCOP, thanks to long split heat exchanger with magic coil treatment.
- Energy saving with the occupancy sensor, automatically switch off the unit if nobody is in the room.



Hi - Res Image



### Performance Data

Capacity Code		HP	3.2
Nominal	Cooling Capacity	kW	9.0
	Heating Capacity	kW	10.0
UK	Cooling Total/Sensible	kW	8.2/5.9
	Heating	kW	6.8
Electrical	Power Input	kW	0.068
	Run Current	Amps	0.6
	Start Current	Amps	0.9

### Indoor Data

Airflow	High - Medium - Low	l/s	539 - 422 - 389
	High - Medium - Low	m <sup>3</sup> /h	1940 - 1520 - 1400
Sound	Pressure High - Medium - Low	dB(A)	44 - 39 - 37
	Power High - Medium - Low	dB(A)	58 - 53 - 51
Unit	Height x Width x Depth	mm	319 x 840 x 840
	Weight	kg	25
Panel	Height x Width x Depth	mm	30 x 950 x 950
	Weight RBC-U41PG(W)-E	kg	5
Pipe Connection	Flare Connections (gas - liquid)	inch	5/8 - 3/8
	Drain Pipe Connection OD/ID	mm	32/25
Power Supply	Suggested Fuse Size	V/ph/Hz-A	220-240/1/50-5

### Accessories

<a href="#">RBC-AMTU31-E</a>	Standard Remote Controller - Full control including service functions
<a href="#">RBC-ASCU11-E</a>	Compact Remote Controller - Includes timer off, back light display, multilingual
<a href="#">RBC-AWSU52-E</a>	Premium Controller - Includes timer and back light display, multilingual (inc. Bluetooth)
<a href="#">RBC-MTSC1</a>	Mini Touch Screen Controller - with configurable icons for indoor units
<a href="#">RBC-MTSC2</a>	Mini Touch Screen Controller - with Schedule Timer, configurable icons for indoor units
<a href="#">TCB-SIR41U-E</a>	Occupancy sensor - Cannot be used with wireless remote control kit.
<a href="#">RBC-AXU41U-E</a>	Wireless remote kit - Cannot be used with Occupancy sensor
<a href="#">TCB-FF101URE2</a>	Auxiliary fresh air flange - For easy fresh air intake by using knock out hole of indoor.

\*All [Accessories](#) / [Controls](#)

Compatible R410a outdoor condensers:

[Mini SMMS-e](#), [SMMS-u](#), [SHRM-e](#)

Compatible R32 outdoor condensers:

[Mini SMMS](#), [SHRM-a](#)

Related items:

- [Full specification](#)
- [Airflow/ fan curve](#)
- [Dimensional drawing](#)
- [Wiring diagram](#)
- [Noise curve data](#)
- [Installation manual](#)

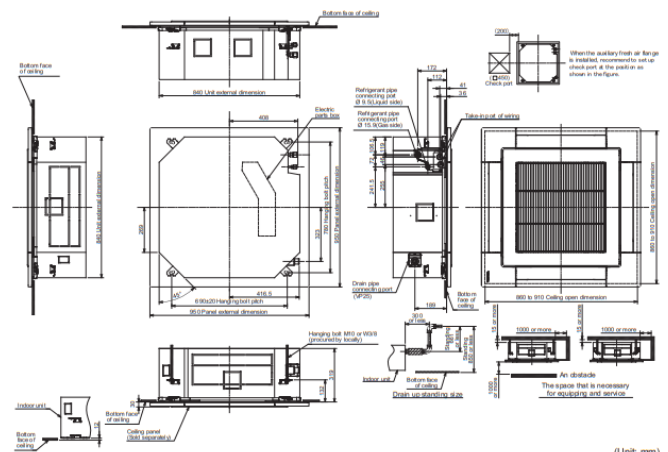

(Unit: mm)

## VRF 4-WAY SMART CASSETTE: MMU - UP0361H-E

- Simple & elegant design fits various rooms.
- 5 fan steps to precisely control the air flow.
- Unique louvre design for optimal air distribution.
- Top class SEER and SCOP, thanks to long split heat exchanger with magic coil treatment.
- Energy saving with the occupancy sensor, automatically switch off the unit if nobody is in the room.



Hi - Res Image



### Performance Data

Capacity Code		HP	4.0
Nominal	Cooling Capacity	kW	11.2
	Heating Capacity	kW	12.5
UK	Cooling Total/Sensible	kW	10.2/7.3
	Heating	kW	8.5
Electrical	Power Input	kW	0.125
	Run Current	Amps	0.94
	Start Current	Amps	1.41

### Indoor Data

Airflow	High - Medium - Low	l/s	607 - 443 - 350
	High - Medium - Low	m3/h	2184 - 1596 - 1260
Sound	Pressure High - Medium - Low	dB(A)	45 - 38 - 32
	Power High - Medium - Low	dB(A)	60 - 53 - 48
Unit	Height x Width x Depth	mm	319 x 840 x 840
	Weight	kg	25
Panel	Height x Width x Depth	mm	30 x 950 x 950
	Weight RBC-U41PG(W)-E	kg	5
Pipe Connection	Flare Connections (gas - liquid)	inch	5/8 - 3/8
	Drain Pipe Connection OD/ID	mm	32/25
Power Supply	Suggested Fuse Size	V/ph/Hz-A	220-240/1/50-5

### Accessories

<a href="#">RBC-AMTU31-E</a>	Standard Remote Controller - Full control including service functions
<a href="#">RBC-ASCU11-E</a>	Compact Remote Controller - Includes timer off, back light display, multilingual
<a href="#">RBC-AWSU52-E</a>	Premium Controller - Includes timer and back light display, multilingual (inc. Bluetooth)
<a href="#">RBC-MTSC1</a>	Mini Touch Screen Controller - with configurable icons for indoor units
<a href="#">RBC-MTSC2</a>	Mini Touch Screen Controller - with Schedule Timer, configurable icons for indoor units
<a href="#">TCB-SIR41U-E</a>	Occupancy sensor - Cannot be used with wireless remote control kit.
<a href="#">RBC-AXU41U-E</a>	Wireless remote kit - Cannot be used with Occupancy sensor
<a href="#">TCB-FF101URE2</a>	Auxiliary fresh air flange - For easy fresh air intake by using knock out hole of indoor.

\*All [Accessories](#) / [Controls](#)

Compatible R410a outdoor condensers:

[Mini SMMS-e](#), [SMMS-u](#), [SHRM-e](#)

Compatible R32 outdoor condensers:

[Mini SMMS](#), [SHRM-a](#)

Related items:

- [Full specification](#)
- [Airflow/ fan curve](#)
- [Dimensional drawing](#)
- [Wiring diagram](#)
- [Noise curve data](#)
- [Installation manual](#)

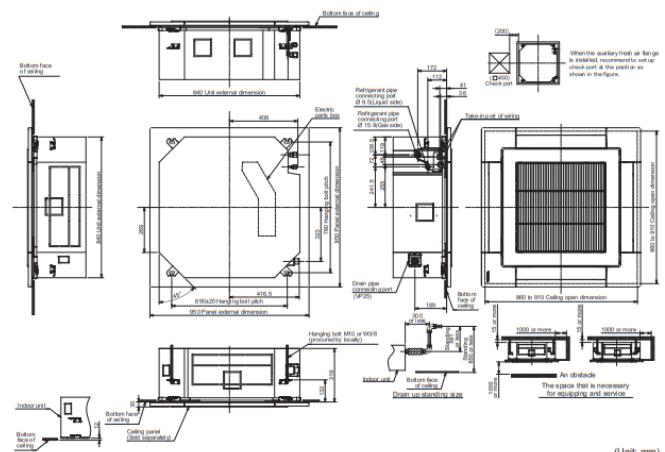

(Unit: mm)

## VRF 4-WAY SMART CASSETTE: MMU - UP0481H-E

- Simple & elegant design fits various rooms.
- 5 fan steps to precisely control the air flow.
- Unique louvre design for optimal air distribution.
- Top class SEER and SCOP, thanks to long split heat exchanger with magic coil treatment.
- Energy saving with the occupancy sensor, automatically switch off the unit if nobody is in the room.



Hi - Res Image



### Performance Data

Capacity Code		HP	5.0
Nominal	Cooling Capacity	kW	14.0
	Heating Capacity	kW	16.0
UK	Cooling Total/Sensible	kW	12.7/9.3
	Heating	kW	10.9
Electrical	Power Input	kW	0.135
	Run Current	Amps	0.96
	Start Current	Amps	1.44

### Indoor Data

Airflow	High - Medium - Low	l/s	628 - 483 - 380
	High - Medium - Low	m3/h	2262 - 1740 - 1368
Sound	Pressure High - Medium - Low	dB(A)	46 - 39 - 33
	Power High - Medium - Low	dB(A)	61 - 54 - 49
Unit	Height x Width x Depth	mm	319 x 840 x 840
	Weight	kg	25
Panel	Height x Width x Depth	mm	30 x 950 x 950
	Weight RBC-U41PG(W)-E	kg	5
Pipe Connection	Flare Connections (gas - liquid)	inch	5/8 - 3/8
	Drain Pipe Connection OD/ID	mm	32/25
Power Supply	Suggested Fuse Size	V/ph/Hz-A	220-240/1/50-5

### Accessories

<a href="#">RBC-AMTU31-E</a>	Standard Remote Controller - Full control including service functions
<a href="#">RBC-ASCU11-E</a>	Compact Remote Controller - Includes timer off, back light display, multilingual
<a href="#">RBC-AWSU52-E</a>	Premium Controller - Includes timer and back light display, multilingual (inc. Bluetooth)
<a href="#">RBC-MTSC1</a>	Mini Touch Screen Controller - with configurable icons for indoor units
<a href="#">RBC-MTSC2</a>	Mini Touch Screen Controller - with Schedule Timer, configurable icons for indoor units
<a href="#">TCB-SIR41U-E</a>	Occupancy sensor - Cannot be used with wireless remote control kit.
<a href="#">RBC-AXU41U-E</a>	Wireless remote kit - Cannot be used with Occupancy sensor
<a href="#">TCB-FF101URE2</a>	Auxiliary fresh air flange - For easy fresh air intake by using knock out hole of indoor.

\*All [Accessories](#) / [Controls](#)

Compatible R410a outdoor condensers:

[Mini SMMS-e](#), [SMMS-u](#), [SHRM-e](#)

Compatible R32 outdoor condensers:

[Mini SMMS](#), [SHRM-a](#)

Related items:

- [Full specification](#)
- [Airflow/ fan curve](#)
- [Dimensional drawing](#)
- [Wiring diagram](#)
- [Noise curve data](#)
- [Installation manual](#)

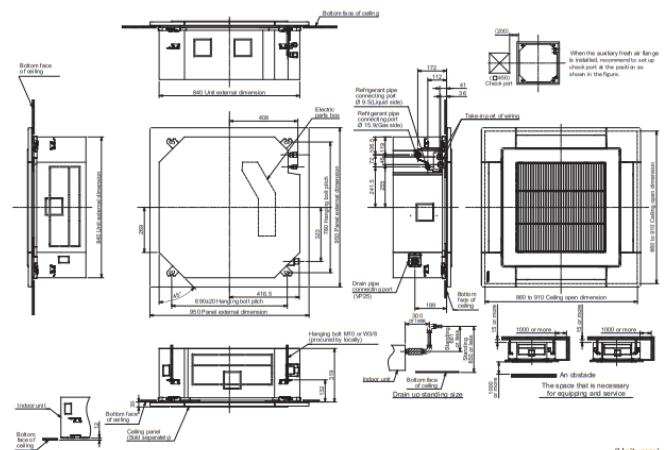

(Unit: mm)

## VRF 4-WAY SMART CASSETTE: MMU - UP0561H-E

- Simple & elegant design fits various rooms.
- 5 fan steps to precisely control the air flow.
- Unique louvre design for optimal air distribution.
- Top class SEER and SCOP, thanks to long split heat exchanger with magic coil treatment.
- Energy saving with the occupancy sensor, automatically switch off the unit if nobody is in the room.



Hi - Res Image



### Performance Data

Capacity Code		HP	6.0
Nominal	Cooling Capacity	kW	16.0
	Heating Capacity	kW	18.0
UK	Cooling Total/Sensible	kW	14.5/10.4
	Heating	kW	12.2
Electrical	Power Input	kW	0.137
	Run Current	Amps	0.97
	Start Current	Amps	1.46

### Indoor Data

Airflow	High - Medium - Low	l/s	628 - 495 - 390
	High - Medium - Low	m3/h	2262 - 1782 - 1404
Sound	Pressure High - Medium - Low	dB(A)	46 - 40 - 35
	Power High - Medium - Low	dB(A)	61 - 55 - 51
Unit	Height x Width x Depth	mm	319 x 840 x 840
	Weight	kg	25
Panel	Height x Width x Depth	mm	30 x 950 x 950
	Weight RBC-U41PG(W)-E	kg	5
Pipe Connection	Flare Connections (gas - liquid)	inch	5/8 - 3/8
	Drain Pipe Connection OD/ID	mm	32/25
Power Supply	Suggested Fuse Size	V/ph/Hz-A	220-240/1/50-5

### Accessories

<a href="#">RBC-AMTU31-E</a>	Standard Remote Controller - Full control including service functions
<a href="#">RBC-ASCU11-E</a>	Compact Remote Controller - Includes timer off, back light display, multilingual
<a href="#">RBC-AWSU52-E</a>	Premium Controller - Includes timer and back light display, multilingual (inc. Bluetooth)
<a href="#">RBC-MTSC1</a>	Mini Touch Screen Controller - with configurable icons for indoor units
<a href="#">RBC-MTSC2</a>	Mini Touch Screen Controller - with Schedule Timer, configurable icons for indoor units
<a href="#">TCB-SIR41U-E</a>	Occupancy sensor - Cannot be used with wireless remote control kit.
<a href="#">RBC-AXU41U-E</a>	Wireless remote kit - Cannot be used with Occupancy sensor
<a href="#">TCB-FF101URE2</a>	Auxiliary fresh air flange - For easy fresh air intake by using knock out hole of indoor.

\*All [Accessories](#) / [Controls](#)

Compatible R410a outdoor condensers:

[Mini SMMS-e](#), [SMMS-u](#), [SHRM-e](#)

Compatible R32 outdoor condensers:

[Mini SMMS](#), [SHRM-a](#)

Related items:

- [Full specification](#)
- [Airflow/ fan curve](#)
- [Dimensional drawing](#)
- [Wiring diagram](#)
- [Noise curve data](#)
- [Installation manual](#)

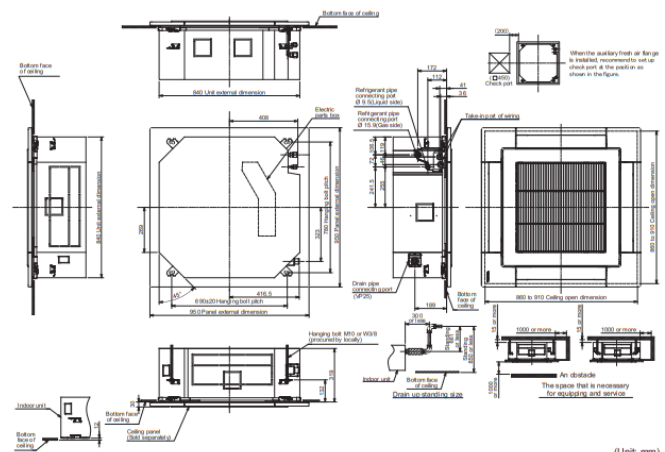

(Unit: mm)



# Slim Ducted



## VRF SLIM DUCTED: MMD - UP0031SPHY-E

- Static pressure up to 50Pa.
- Slimline design, with a height of just 21cm.
- Exceptionally low noise level - down to 25 dB(A).
- For a wide range of applications, such as hotels, offices and shops.
- Ideal for sites that have restrictions on the space above ceiling level.



Hi - Res Image



### Performance Data

Capacity Code		HP	0.3
Nominal	Cooling Capacity	kW	0.9
	Heating Capacity	kW	1.0
UK	Cooling Total/Sensible	kW	0.8/0.6
	Heating	kW	0.7
Electrical	Power Input	kW	0.018
	Run Current	Amps	0.34
	Start Current	Amps	0.60

### Indoor Data

Airflow	High - Medium - Low	l/s	114 - 103 - 97
	High - Medium - Low	m <sup>3</sup> /h	410 - 370 - 350
External Static Pressure	Standard	Pa	10
	Maximum	Pa	50
Sound Pressure	Back Inlet High - Medium - Low	dB(A)	29 - 27 - 25
	Under Inlet High - Medium - Low	dB(A)	37 - 35 - 32
Sound Power	Back Inlet High - Medium - Low	dB(A)	46 - 44 - 42
	Under Inlet High - Medium - Low	dB(A)	51 - 49 - 47
Unit	Height x Width x Depth	mm	210 x 700 x 450
	Weight	kg	15
Pipe Connection	Flare Connections (gas - liquid)	inch	3/8 - 1/4
	Drain Pipe Connection OD/ID	mm	32/25
	Lift Pump Drain Height from Unit Base	mm	<550
Power Supply	Suggested Fuse Size	V/ph/Hz-A	220-240/1/50-5

### Accessories

<a href="#">RBC-AMTU31-E</a>	Standard Remote Controller - Full control including service functions
<a href="#">RBC-ASCU11-E</a>	Compact Remote Controller - Includes timer off, back light display, multilingual
<a href="#">RBC-AWSU52-E</a>	Premium Controller - Includes timer and back light display, multilingual (inc. Bluetooth)
<a href="#">RBC-MTSC1</a>	Mini Touch Screen Controller - with configurable icons for indoor units
<a href="#">RBC-MTSC2</a>	Mini Touch Screen Controller - with Schedule Timer, configurable icons for indoor units
<a href="#">TCB-TDL0141SDY-E</a>	Motorized horizontal louvre - For models - (0031/0051/0071/0091/0121)
<a href="#">TCB-TDL0181SDY-E</a>	Motorized horizontal louvre - For models - (0151/0181)
<a href="#">TCB-TDL0271SDY-E</a>	Motorized horizontal louvre - For models - (0241/0271)

\*All [Accessories](#) / [Controls](#)

Compatible R410a outdoor condensers:

[Mini SMMS-e](#), [SMMS-u](#), [SHRM-e](#)

Compatible R32 outdoor condensers:

[Mini SMMS](#), [SHRM-a](#)

Related items:

- [Full specification](#)
- [BIM files](#)
- [CAD files](#)
- [Airflow/ fan curve](#)
- [Dimensional drawing](#)
- [Wiring diagram](#)
- [Noise curve data](#)
- [Installation manual](#)

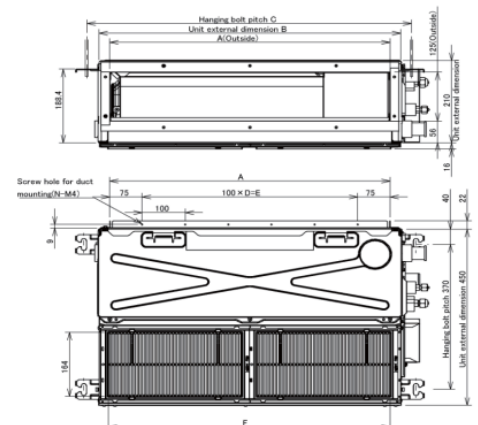
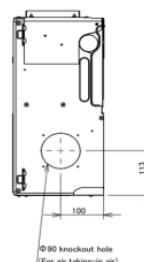

## VRF SLIM DUCTED: MMD - UP0051SPHY-E

- Static pressure up to 50Pa.
- Slimline design, with a height of just 21cm.
- Exceptionally low noise level – down to 26 dB(A).
- For a wide range of applications, such as hotels, offices and shops.
- Ideal for sites that have restrictions on the space above ceiling level.



Hi - Res Image 



### Performance Data

Capacity Code		HP	0.6
Nominal	Cooling Capacity	kW	1.7
	Heating Capacity	kW	1.9
UK	Cooling Total/Sensible	kW	1.5/1.1
	Heating	kW	1.3
Electrical	Power Input	kW	0.020
	Run Current	Amps	0.36
	Start Current	Amps	0.62

### Indoor Data

Airflow	High - Medium - Low	l/s	125 - 114 - 106
	High - Medium - Low	m3/h	450 - 410 - 380
External Static Pressure	Standard	Pa	10
	Maximum	Pa	50
Sound Pressure	Back Inlet High - Medium - Low	dB(A)	30 - 28 - 26
	Under Inlet High - Medium - Low	dB(A)	39 - 37 - 34
Sound Power	Back Inlet High - Medium - Low	dB(A)	49 - 46 - 44
	Under Inlet High - Medium - Low	dB(A)	53 - 51 - 48
Unit	Height x Width x Depth	mm	210 x 700 x 450
	Weight	kg	15
Pipe Connection	Flare Connections (gas - liquid)	inch	3/8 - 1/4
	Drain Pipe Connection OD/ID	mm	32/25
	Lift Pump Drain Height from Unit Base	mm	< 550
Power Supply	Suggested Fuse Size	V/ph/Hz-A	220-240/1/50-5

### Accessories

<a href="#">RBC-AMTU31-E</a>	Standard Remote Controller - Full control including service functions
<a href="#">RBC-ASCU11-E</a>	Compact Remote Controller - Includes timer off, back light display, multilingual
<a href="#">RBC-AWSU52-E</a>	Premium Controller - Includes timer and back light display, multilingual (inc. Bluetooth)
<a href="#">RBC-MTSC1</a>	Mini Touch Screen Controller - with configurable icons for indoor units
<a href="#">RBC-MTSC2</a>	Mini Touch Screen Controller - with Schedule Timer, configurable icons for indoor units
<a href="#">TCB-TDL0141SDY-E</a>	Motorized horizontal louvre - For models - (0031/0051/0071/0091/0121)
<a href="#">TCB-TDL0181SDY-E</a>	Motorized horizontal louvre - For models - (0151/0181)
<a href="#">TCB-TDL0271SDY-E</a>	Motorized horizontal louvre - For models - (0241/0271)

\*All [Accessories](#) / [Controls](#)

Compatible R410a outdoor condensers:

[Mini SMMS-e](#), [SMMS-u](#), [SHRM-e](#)

Compatible R32 outdoor condensers:

[Mini SMMS](#), [SHRM-a](#)

Related items:

- [Full specification](#)
- [BIM files](#)
- [CAD files](#)
- [Airflow/ fan curve](#)
- [Dimensional drawing](#)
- [Wiring diagram](#)
- [Noise curve data](#)
- [Installation manual](#)

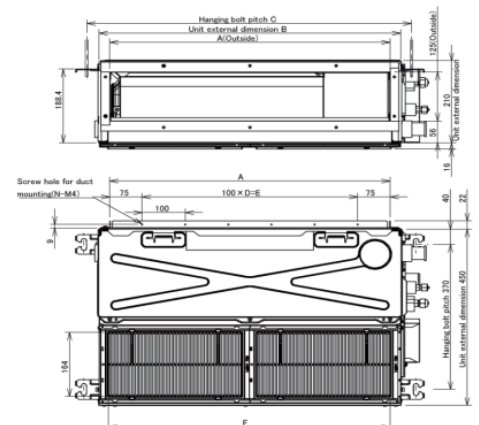
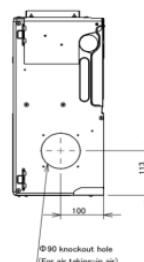

## VRF SLIM DUCTED: MMD - UP0071SPHY-E

- Static pressure up to 50Pa.
- Slimline design, with a height of just 21cm.
- Exceptionally low noise level – down to 26 dB(A).
- For a wide range of applications, such as hotels, offices and shops.
- Ideal for sites that have restrictions on the space above ceiling level.



Hi - Res Image



### Performance Data

Capacity Code		HP	0.8
Nominal	Cooling Capacity	kW	2.2
	Heating Capacity	kW	2.5
UK	Cooling Total/Sensible	kW	2.0/1.6
	Heating	kW	1.7
Electrical	Power Input	kW	0.026
	Run Current	Amps	0.40
	Start Current	Amps	0.69

### Indoor Data

Airflow	High - Medium - Low	l/s	150 - 128 - 111
	High - Medium - Low	m3/h	540 - 460 - 400
External Static Pressure	Standard	Pa	10
	Maximum	Pa	50
Sound Pressure	Back Inlet High - Medium - Low	dB(A)	31 - 29 - 26
	Under Inlet High - Medium - Low	dB(A)	41 - 39 - 35
Sound Power	Back Inlet High - Medium - Low	dB(A)	52 - 49 - 45
	Under Inlet High - Medium - Low	dB(A)	54 - 49 - 46
Unit	Height x Width x Depth	mm	210 x 700 x 450
	Weight	kg	15
Pipe Connection	Flare Connections (gas - liquid)	inch	3/8 - 1/4
	Drain Pipe Connection OD/ID	mm	32/25
	Lift Pump Drain Height from Unit Base	mm	< 550
Power Supply	Suggested Fuse Size	V/ph/Hz-A	220-240/1/50-5

### Accessories

<a href="#">RBC-AMTU31-E</a>	Standard Remote Controller - Full control including service functions
<a href="#">RBC-ASCU11-E</a>	Compact Remote Controller - Includes timer off, back light display, multilingual
<a href="#">RBC-AWSU52-E</a>	Premium Controller - Includes timer and back light display, multilingual (inc. Bluetooth)
<a href="#">RBC-MTSC1</a>	Mini Touch Screen Controller - with configurable icons for indoor units
<a href="#">RBC-MTSC2</a>	Mini Touch Screen Controller - with Schedule Timer, configurable icons for indoor units
<a href="#">TCB-TDL0141SDY-E</a>	Motorized horizontal louvre - For models - (0031/0051/0071/0091/0121)
<a href="#">TCB-TDL0181SDY-E</a>	Motorized horizontal louvre - For models - (0151/0181)
<a href="#">TCB-TDL0271SDY-E</a>	Motorized horizontal louvre - For models - (0241/0271)

\*All [Accessories](#) / [Controls](#)

Compatible R410a outdoor condensers:

[Mini SMMS-e](#), [SMMS-u](#), [SHRM-e](#)

Compatible R32 outdoor condensers:

[Mini SMMS](#), [SHRM-a](#)

Related items:

- [Full specification](#)
- [BIM files](#)
- [CAD files](#)
- [Airflow/ fan curve](#)
- [Dimensional drawing](#)
- [Wiring diagram](#)
- [Noise curve data](#)
- [Installation manual](#)

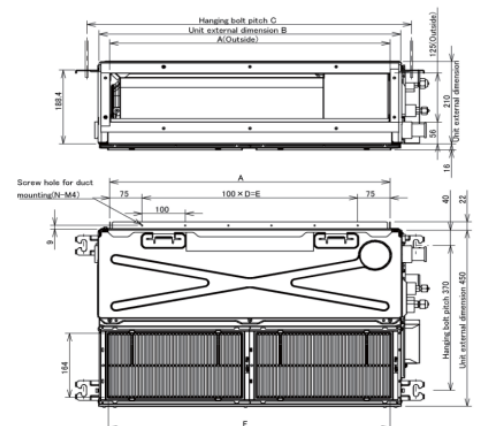
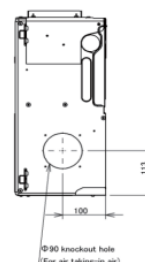

## VRF SLIM DUCTED: MMD - UP0091SPHY-E

- Static pressure up to 50Pa.
- Slimline design, with a height of just 21cm.
- Exceptionally low noise level – down to 26 dB(A).
- For a wide range of applications, such as hotels, offices and shops.
- Ideal for sites that have restrictions on the space above ceiling level.



Hi - Res Image 



### Performance Data

Capacity Code		HP	1.0
Nominal	Cooling Capacity	kW	2.8
	Heating Capacity	kW	3.2
UK	Cooling Total/Sensible	kW	2.5/2.0
	Heating	kW	2.2
Electrical	Power Input	kW	0.029
	Run Current	Amps	0.42
	Start Current	Amps	0.73

### Indoor Data

Airflow	High - Medium - Low	l/s	158 - 139 - 117
	High - Medium - Low	m3/h	570 - 500 - 420
External Static Pressure	Standard	Pa	10
	Maximum	Pa	50
Sound Pressure	Back Inlet High - Medium - Low	dB(A)	32 - 29 - 26
	Under Inlet High - Medium - Low	dB(A)	42 - 40 - 36
Sound Power	Back Inlet High - Medium - Low	dB(A)	54 - 50 - 46
	Under Inlet High - Medium - Low	dB(A)	56 - 52 - 49
Unit	Height x Width x Depth	mm	210 x 700 x 450
	Weight	kg	15
Pipe Connection	Flare Connections (gas - liquid)	inch	3/8 - 1/4
	Drain Pipe Connection OD/ID	mm	32/25
	Lift Pump Drain Height from Unit Base	mm	< 550
Power Supply	Suggested Fuse Size	V/ph/Hz-A	220-240/1/50-5

### Accessories

<a href="#">RBC-AMTU31-E</a>	Standard Remote Controller - Full control including service functions
<a href="#">RBC-ASCU11-E</a>	Compact Remote Controller - Includes timer off, back light display, multilingual
<a href="#">RBC-AWSU52-E</a>	Premium Controller - Includes timer and back light display, multilingual (inc. Bluetooth)
<a href="#">RBC-MTSC1</a>	Mini Touch Screen Controller - with configurable icons for indoor units
<a href="#">RBC-MTSC2</a>	Mini Touch Screen Controller - with Schedule Timer, configurable icons for indoor units
<a href="#">TCB-TDL0141SDY-E</a>	Motorized horizontal louvre - For models - (0031/0051/0071/0091/0121)
<a href="#">TCB-TDL0181SDY-E</a>	Motorized horizontal louvre - For models - (0151/0181)
<a href="#">TCB-TDL0271SDY-E</a>	Motorized horizontal louvre - For models - (0241/0271)

\*All [Accessories](#) / [Controls](#)

Compatible R410a outdoor condensers:

[Mini SMMS-e](#), [SMMS-u](#), [SHRM-e](#)

Compatible R32 outdoor condensers:

[Mini SMMS](#), [SHRM-a](#)

Related items:

- [Full specification](#)
- [BIM files](#)
- [CAD files](#)
- [Airflow/ fan curve](#)
- [Dimensional drawing](#)
- [Wiring diagram](#)
- [Noise curve data](#)
- [Installation manual](#)

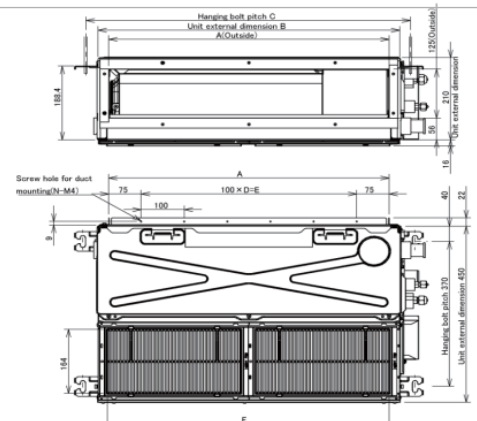
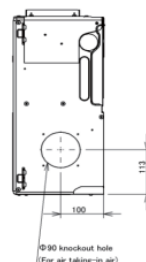

## VRF SLIM DUCTED: MMD - UP0121SPHY-E

- Static pressure up to 50Pa.
- Slimline design, with a height of just 21cm.
- Exceptionally low noise level – down to 27 dB(A).
- For a wide range of applications, such as hotels, offices and shops.
- Ideal for sites that have restrictions on the space above ceiling level.



Hi - Res Image 



### Performance Data

Capacity Code		HP	1.3
Nominal	Cooling Capacity	kW	3.6
	Heating Capacity	kW	4.0
UK	Cooling Total/Sensible	kW	3.3/2.5
	Heating	kW	2.7
Electrical	Power Input	kW	0.031
	Run Current	Amps	0.44
	Start Current	Amps	0.77

### Indoor Data

Airflow	High - Medium - Low	l/s	167 - 144 - 122
	High - Medium - Low	m <sup>3</sup> /h	600 - 520 - 440
External Static Pressure	Standard	Pa	10
	Maximum	Pa	50
Sound Pressure	Back Inlet High - Medium - Low	dB(A)	33 - 30 - 27
	Under Inlet High - Medium - Low	dB(A)	44 - 40 - 37
Sound Power	Back Inlet High - Medium - Low	dB(A)	54 - 50 - 46
	Under Inlet High - Medium - Low	dB(A)	57 - 53 - 49
Unit	Height x Width x Depth	mm	210 x 700 x 450
	Weight	kg	15
Pipe Connection	Flare Connections (gas - liquid)	inch	3/8 - 1/4
	Drain Pipe Connection OD/ID	mm	32/25
	Lift Pump Drain Height from Unit Base	mm	< 550
Power Supply	Suggested Fuse Size	V/ph/Hz-A	220-240/1/50-5

### Accessories

<a href="#">RBC-AMTU31-E</a>	Standard Remote Controller - Full control including service functions
<a href="#">RBC-ASCU11-E</a>	Compact Remote Controller - Includes timer off, back light display, multilingual
<a href="#">RBC-AWSU52-E</a>	Premium Controller - Includes timer and back light display, multilingual (inc. Bluetooth)
<a href="#">RBC-MTSC1</a>	Mini Touch Screen Controller - with configurable icons for indoor units
<a href="#">RBC-MTSC2</a>	Mini Touch Screen Controller - with Schedule Timer, configurable icons for indoor units
<a href="#">TCB-TDL0141SDY-E</a>	Motorized horizontal louvre - For models - (0031/0051/0071/0091/0121)
<a href="#">TCB-TDL0181SDY-E</a>	Motorized horizontal louvre - For models - (0151/0181)
<a href="#">TCB-TDL0271SDY-E</a>	Motorized horizontal louvre - For models - (0241/0271)

### \*All Accessories / Controls

Compatible R410a outdoor condensers:

**[Mini SMMS-e](#), [SMMS-u](#), [SHRM-e](#)**

Compatible R32 outdoor condensers:

**[Mini SMMS](#), [SHRM-a](#)**

Related items:

- [Full specification](#)
- [BIM files](#)
- [CAD files](#)
- [Airflow/ fan curve](#)
- [Dimensional drawing](#)
- [Wiring diagram](#)
- [Noise curve data](#)
- [Installation manual](#)

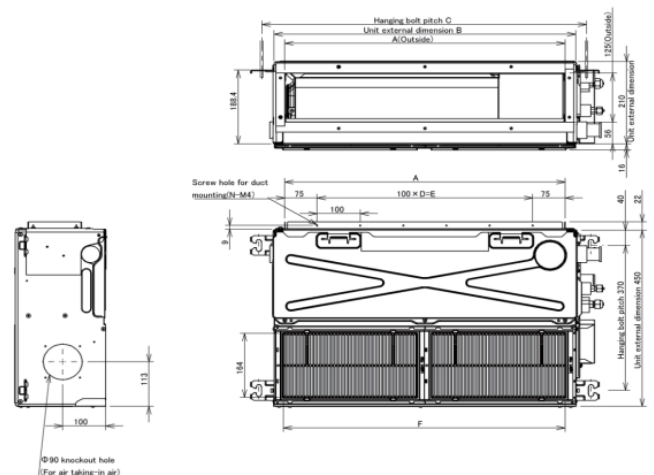

## VRF SLIM DUCTED: MMD - UP0151SPHY-E

- Static pressure up to 50Pa.
- Slimline design, with a height of just 21cm.
- Exceptionally low noise level – down to 28 dB(A).
- For a wide range of applications, such as hotels, offices and shops.
- Ideal for sites that have restrictions on the space above ceiling level.



Hi - Res Image 



### Performance Data

Capacity Code		HP	1.7
Nominal	Cooling Capacity	kW	4.5
	Heating Capacity	kW	5.0
UK	Cooling Total/Sensible	kW	4.1/2.9
	Heating	kW	3.4
Electrical	Power Input	kW	0.035
	Run Current	Amps	0.47
	Start Current	Amps	0.82

### Indoor Data

Airflow	High - Medium - Low	l/s	192 - 178 - 153
	High - Medium - Low	m3/h	690 - 640 - 550
External Static Pressure	Standard	Pa	10
	Maximum	Pa	50
Sound Pressure	Back Inlet High - Medium - Low	dB(A)	33 - 30 - 28
	Under Inlet High - Medium - Low	dB(A)	42 - 39 - 37
Sound Power	Back Inlet High - Medium - Low	dB(A)	52 - 50 - 46
	Under Inlet High - Medium - Low	dB(A)	55 - 53 - 49
Unit	Height x Width x Depth	mm	210 x 900 x 450
	Weight	kg	19
Pipe Connection	Flare Connections (gas - liquid)	inch	1/2 - 1/4
	Drain Pipe Connection OD/ID	mm	32/25
	Lift Pump Drain Height from Unit Base	mm	< 650
Power Supply	Suggested Fuse Size	V/ph/Hz-A	220-240/1/50-5

### Accessories

<a href="#">RBC-AMTU31-E</a>	Standard Remote Controller - Full control including service functions
<a href="#">RBC-ASCU11-E</a>	Compact Remote Controller - Includes timer off, back light display, multilingual
<a href="#">RBC-AWSU52-E</a>	Premium Controller - Includes timer and back light display, multilingual (inc. Bluetooth)
<a href="#">RBC-MTSC1</a>	Mini Touch Screen Controller - with configurable icons for indoor units
<a href="#">RBC-MTSC2</a>	Mini Touch Screen Controller - with Schedule Timer, configurable icons for indoor units
<a href="#">TCB-TDL0141SDY-E</a>	Motorized horizontal louvre - For models - (0031/0051/0071/0091/0121)
<a href="#">TCB-TDL0181SDY-E</a>	Motorized horizontal louvre - For models - (0151/0181)
<a href="#">TCB-TDL0271SDY-E</a>	Motorized horizontal louvre - For models - (0241/0271)

\*All [Accessories](#) / [Controls](#)

Compatible R410a outdoor condensers:

[Mini SMMS-e](#), [SMMS-u](#), [SHRM-e](#)

Compatible R32 outdoor condensers:

[Mini SMMS](#), [SHRM-a](#)

Related items:

- [Full specification](#)
- [BIM files](#)
- [CAD files](#)
- [Airflow/ fan curve](#)
- [Dimensional drawing](#)
- [Wiring diagram](#)
- [Noise curve data](#)
- [Installation manual](#)

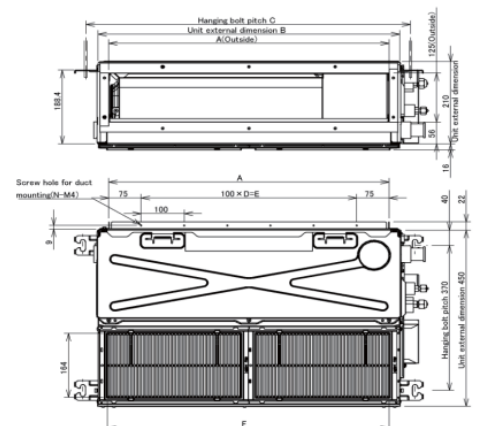
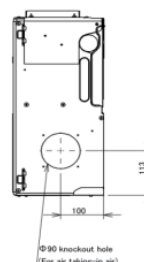

## VRF SLIM DUCTED: MMD - UP0181SPHY-E

- Static pressure up to 50Pa.
- Slimline design, with a height of just 21cm.
- Exceptionally low noise level – down to 29 dB(A).
- For a wide range of applications, such as hotels, offices and shops.
- Ideal for sites that have restrictions on the space above ceiling level.



Hi - Res Image 



### Performance Data

Capacity Code		HP	2.0
Nominal	Cooling Capacity	kW	5.6
	Heating Capacity	kW	6.3
UK	Cooling Total/Sensible	kW	5.1/3.5
	Heating	kW	4.3
	Power Input	kW	0.044
Electrical	Run Current	Amps	0.53
	Start Current	Amps	0.92

### Indoor Data

Airflow	High - Medium - Low	l/s	217 - 203 - 181
	High - Medium - Low	m3/h	780 - 730 - 650
External Static Pressure	Standard	Pa	10
	Maximum	Pa	50
Sound Pressure	Back Inlet High - Medium - Low	dB(A)	34 - 32 - 29
	Under Inlet High - Medium - Low	dB(A)	44 - 42 - 39
Sound Power	Back Inlet High - Medium - Low	dB(A)	56 - 54 - 51
	Under Inlet High - Medium - Low	dB(A)	57 - 55 - 52
Unit	Height x Width x Depth	mm	210 x 900 x 450
	Weight	kg	19
Pipe Connection	Flare Connections (gas - liquid)	inch	1/2 - 1/4
	Drain Pipe Connection OD/ID	mm	32/25
	Lift Pump Drain Height from Unit Base	mm	< 650
Power Supply	Suggested Fuse Size	V/ph/Hz-A	220-240/1/50-5

### Accessories

<a href="#">RBC-AMTU31-E</a>	Standard Remote Controller - Full control including service functions
<a href="#">RBC-ASCU11-E</a>	Compact Remote Controller - Includes timer off, back light display, multilingual
<a href="#">RBC-AWSU52-E</a>	Premium Controller - Includes timer and back light display, multilingual (inc. Bluetooth)
<a href="#">RBC-MTSC1</a>	Mini Touch Screen Controller - with configurable icons for indoor units
<a href="#">RBC-MTSC2</a>	Mini Touch Screen Controller - with Schedule Timer, configurable icons for indoor units
<a href="#">TCB-TDL0141SDY-E</a>	Motorized horizontal louvre - For models - (0031/0051/0071/0091/0121)
<a href="#">TCB-TDL0181SDY-E</a>	Motorized horizontal louvre - For models - (0151/0181)
<a href="#">TCB-TDL0271SDY-E</a>	Motorized horizontal louvre - For models - (0241/0271)

#### \*All Accessories / Controls

Compatible R410a outdoor condensers:

**[Mini SMMS-e](#), [SMMS-u](#), [SHRM-e](#)**

Compatible R32 outdoor condensers:

**[Mini SMMS](#), [SHRM-a](#)**

Related items:

- [Full specification](#)
- [BIM files](#)
- [CAD files](#)
- [Airflow/ fan curve](#)
- [Dimensional drawing](#)
- [Wiring diagram](#)
- [Noise curve data](#)
- [Installation manual](#)

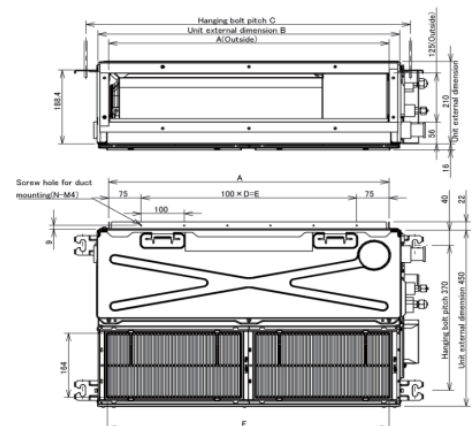
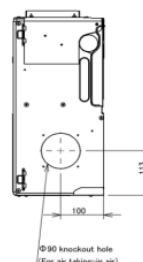



## VRF SLIM DUCTED: MMD - UP0241SPHY-E

- Static pressure up to 50Pa.
- Slimline design, with a height of just 21cm.
- Exceptionally low noise level – down to 30 dB(A).
- For a wide range of applications, such as hotels, offices and shops.
- Ideal for sites that have restrictions on the space above ceiling level.



Hi - Res Image



### Performance Data

Capacity Code		HP	2.5
Nominal	Cooling Capacity	kW	7.1
	Heating Capacity	kW	8.0
UK	Cooling Total/Sensible	kW	6.4/4.4
	Heating	kW	5.4
Electrical	Power Input	kW	0.067
	Run Current	Amps	0.59
	Start Current	Amps	1.21

### Indoor Data

Airflow	High - Medium - Low	l/s	300 - 264 - 239
	High - Medium - Low	m3/h	1080 - 950 - 860
External Static Pressure	Standard	Pa	10
	Maximum	Pa	50
Sound Pressure	Back Inlet High - Medium - Low	dB(A)	36 - 33 - 30
	Under Inlet High - Medium - Low	dB(A)	47 - 44 - 41
Sound Power	Back Inlet High - Medium - Low	dB(A)	60 - 56 - 53
	Under Inlet High - Medium - Low	dB(A)	64 - 60 - 58
Unit	Height x Width x Depth	mm	210 x 1100 x 450
	Weight	kg	22
Pipe Connection	Flare Connections (gas - liquid)	inch	5/8 - 3/8
	Drain Pipe Connection OD/ID	mm	32/25
	Lift Pump Drain Height from Unit Base	mm	<750
Power Supply	Suggested Fuse Size	V/ph/Hz-A	220-240/1/50-5

### Accessories

<a href="#">RBC-AMTU31-E</a>	Standard Remote Controller - Full control including service functions
<a href="#">RBC-ASCU11-E</a>	Compact Remote Controller - Includes timer off, back light display, multilingual
<a href="#">RBC-AWSU52-E</a>	Premium Controller - Includes timer and back light display, multilingual (inc. Bluetooth)
<a href="#">RBC-MTSC1</a>	Mini Touch Screen Controller - with configurable icons for indoor units
<a href="#">RBC-MTSC2</a>	Mini Touch Screen Controller - with Schedule Timer, configurable icons for indoor units
<a href="#">TCB-TDL0141SDY-E</a>	Motorized horizontal louvre - For models - (0031/0051/0071/0091/0121)
<a href="#">TCB-TDL0181SDY-E</a>	Motorized horizontal louvre - For models - (0151/0181)
<a href="#">TCB-TDL0271SDY-E</a>	Motorized horizontal louvre - For models - (0241/0271)

#### \*All Accessories / Controls

Compatible R410a outdoor condensers:

**[Mini SMMS-e, SMMS-u, SHRM-e](#)**

Compatible R32 outdoor condensers:

**[Mini SMMS, SHRM-a](#)**

Related items:

- [Full specification](#)
- [BIM files](#)
- [CAD files](#)
- [Airflow/ fan curve](#)
- [Dimensional drawing](#)
- [Wiring diagram](#)
- [Noise curve data](#)
- [Installation manual](#)

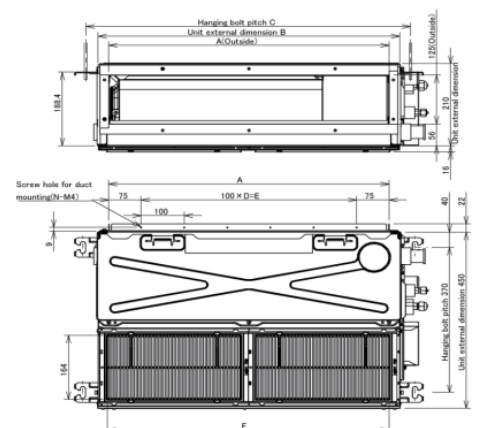
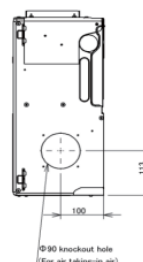

## VRF SLIM DUCTED: MMD - UP0271SPHY-E

- Static pressure up to 50Pa.
- Slimline design, with a height of just 21cm.
- Exceptionally low noise level – down to 32 dB(A).
- For a wide range of applications, such as hotels, offices and shops.
- Ideal for sites that have restrictions on the space above ceiling level.



Hi - Res Image



### Performance Data

Capacity Code		HP	3.0
Nominal	Cooling Capacity	kW	8.0
	Heating Capacity	kW	9.0
UK	Cooling Total/Sensible	kW	7.3/4.9
	Heating	kW	6.1
Electrical	Power Input	kW	0.072
	Run Current	Amps	0.74
	Start Current	Amps	1.30

### Indoor Data

Airflow	High - Medium - Low	l/s	317 - 272 - 253
	High - Medium - Low	m <sup>3</sup> /h	1140 - 980 - 910
External Static Pressure	Standard	Pa	10
	Maximum	Pa	50
Sound Pressure	Back Inlet High - Medium - Low	dB(A)	37 - 34 - 32
	Under Inlet High - Medium - Low	dB(A)	48 - 45 - 43
Sound Power	Back Inlet High - Medium - Low	dB(A)	61 - 58 - 55
	Under Inlet High - Medium - Low	dB(A)	65 - 61 - 59
Unit	Height x Width x Depth	mm	210 x 1100 x 450
	Weight	kg	22
Pipe Connection	Flare Connections (gas - liquid)	inch	5/8 - 3/8
	Drain Pipe Connection OD/ID	mm	32/25
	Lift Pump Drain Height from Unit Base	mm	< 750
Power Supply	Suggested Fuse Size	V/ph/Hz-A	220-240/1/50-5

### Accessories

<a href="#">RBC-AMTU31-E</a>	Standard Remote Controller - Full control including service functions
<a href="#">RBC-ASCU11-E</a>	Compact Remote Controller - Includes timer off, back light display, multilingual
<a href="#">RBC-AWSU52-E</a>	Premium Controller - Includes timer and back light display, multilingual (inc. Bluetooth)
<a href="#">RBC-MTSC1</a>	Mini Touch Screen Controller - with configurable icons for indoor units
<a href="#">RBC-MTSC2</a>	Mini Touch Screen Controller - with Schedule Timer, configurable icons for indoor units
<a href="#">TCB-TDL0141SDY-E</a>	Motorized horizontal louvre - For models - (0031/0051/0071/0091/0121)
<a href="#">TCB-TDL0181SDY-E</a>	Motorized horizontal louvre - For models - (0151/0181)
<a href="#">TCB-TDL0271SDY-E</a>	Motorized horizontal louvre - For models - (0241/0271)

\*All [Accessories / Controls](#)

Compatible R410a outdoor condensers:

[Mini SMMS-e](#), [SMMS-u](#), [SHRM-e](#)

Compatible R32 outdoor condensers:

[Mini SMMS](#), [SHRM-a](#)

Related items:

- [Full specification](#)
- [BIM files](#)
- [CAD files](#)
- [Airflow/ fan curve](#)
- [Dimensional drawing](#)
- [Wiring diagram](#)
- [Noise curve data](#)
- [Installation manual](#)

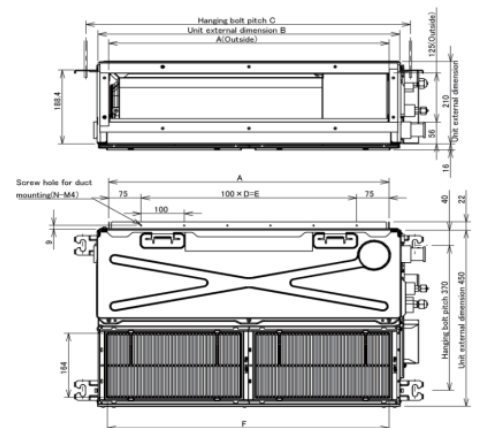
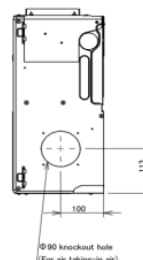

# Standard Ducted



## VRF STANDARD DUCTED: MMD - UP0051BHP-E

- Air discharge spigot available as an option.
- External static pressure can be raised up to 150 Pa.
- With a depth of just 275mm helps to simplify the installation.
- Superior low noise operation. Noise output at low fan equates to just 23 dB(A).
- Can be configured between the standard rear inlet design or, from the underside of the unit.
- **Vertical conversion available upon request.**



Hi - Res Image 



### Performance Data

Capacity Code		HP	0.6
Nominal	Cooling Capacity	kW	1.7
	Heating Capacity	kW	1.9
UK	Cooling Total/Sensible	kW	1.5/1.3
	Heating	kW	1.3
Electrical	Power Input	kW	0.055
	Run Current	Amps	0.35
	Start Current	Amps	0.55

### Indoor Data

Airflow	High - Medium - Low	l/s	150 - 125 - 100
	High - Medium - Low	m3/h	540 - 450 - 360
External Static Pressure	Standard	Pa	30
	Maximum	Pa	150
Sound	Pressure High - Medium - Low	dB(A)	29 - 26 - 23
	Power High - Medium - Low	dB(A)	44 - 41 - 38
Unit	Height x Width x Depth (Horizontal)	mm	275 x 700 x 750
	Height x Width x Depth (Vertical)	mm	750 x 700 x 275
	Weight	kg	23
Pipe Connection	Flare Connections (gas - liquid)	inch	3/8 - 1/4
	Drain Pipe Connection OD/ID	mm	32/25
	Lift Pump Drain Height from Unit Base	mm	< 850
Power Supply	Suggested Fuse Size	V/ph/Hz-A	220-240/1/50-5

### Accessories

<a href="#">RBC-AMTU31-E</a>	Standard Remote Controller - Full control including service functions
<a href="#">RBC-ASCU11-E</a>	Compact Remote Controller - Includes timer off, back light display, multilingual
<a href="#">RBC-AWSU52-E</a>	Premium Controller - Includes timer and back light display, multilingual (inc. Bluetooth)
<a href="#">RBC-MTSC1</a>	Mini Touch Screen Controller - with configurable icons for indoor units
<a href="#">RBC-MTSC2</a>	Mini Touch Screen Controller - with Schedule Timer, configurable icons for indoor units
<a href="#">TCB-SF56C6BE</a>	Spigot shaped flange - For models - (0071/0091/0121/0151/0181) - Spigot diameter 200mm
<a href="#">TCB-SF80C6BE</a>	Spigot shaped flange - For models - (0241/0271/0301) - Spigot diameter 200mm
<a href="#">TCB-SF160C6BE</a>	Spigot shaped flange - For models - (0361/0481/0561) - Spigot diameter 200mm

\*All [Accessories](#) / [Controls](#)

Compatible R410a outdoor condensers:

[Mini SMMS-e](#), [SMMS-u](#), [SHRM-e](#)

Compatible R32 outdoor condensers:

[Mini SMMS](#), [SHRM-a](#)

Related items:

- [Full specification](#)
- [BIM files](#)
- [CAD files](#)
- [Airflow/ fan curve](#)
- [Dimensional drawing](#)
- [Wiring diagram](#)
- [Noise curve data](#)
- [Installation manual](#)

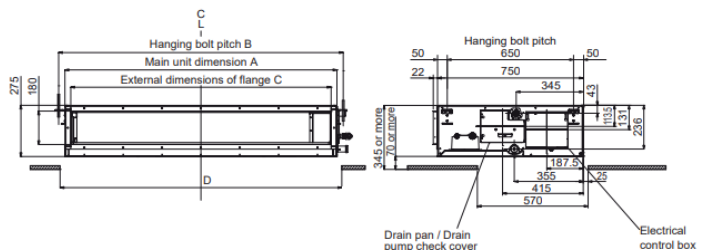

## VRF STANDARD DUCTED: MMD - UP0071BHP-E

- Air discharge spigot available as an option.
- External static pressure can be raised up to 150 Pa.
- With a depth of just 275mm helps to simplify the installation.
- Superior low noise operation. Noise output at low fan equates to just 23 dB(A).
- Can be configured between the standard rear inlet design or, from the underside of the unit.
- **Vertical conversion available upon request.**



Hi - Res Image 



### Performance Data

Capacity Code		HP	0.8
Nominal	Cooling Capacity	kW	2.2
	Heating Capacity	kW	2.5
UK	Cooling Total/Sensible	kW	2.0/1.7
	Heating	kW	1.7
Electrical	Power Input	kW	0.055
	Run Current	Amps	0.35
	Start Current	Amps	0.55

### Indoor Data

Airflow	High - Medium - Low	l/s	150 - 125 - 100
	High - Medium - Low	m3/h	540 - 450 - 360
External Static Pressure	Standard	Pa	30
	Maximum	Pa	150
Sound	Pressure High - Medium - Low	dB(A)	29 - 26 - 23
	Power High - Medium - Low	dB(A)	44 - 41 - 38
Unit	Height x Width x Depth (Horizontal)	mm	275 x 700 x 750
	Height x Width x Depth (Vertical)	mm	750 x 700 x 275
	Weight	kg	23
Pipe Connection	Flare Connections (gas - liquid)	inch	3/8 - 1/4
	Drain Pipe Connection OD/ID	mm	32/25
	Lift Pump Drain Height from Unit Base	mm	< 850
Power Supply	Suggested Fuse Size	V/ph/Hz-A	220-240/1/50-5

### Accessories

<a href="#">RBC-AMTU31-E</a>	Standard Remote Controller - Full control including service functions
<a href="#">RBC-ASCU11-E</a>	Compact Remote Controller - Includes timer off, back light display, multilingual
<a href="#">RBC-AWSU52-E</a>	Premium Controller - Includes timer and back light display, multilingual (inc. Bluetooth)
<a href="#">RBC-MTSC1</a>	Mini Touch Screen Controller - with configurable icons for indoor units
<a href="#">RBC-MTSC2</a>	Mini Touch Screen Controller - with Schedule Timer, configurable icons for indoor units
<a href="#">TCB-SF56C6BE</a>	Spigot shaped flange - For models - (0071/0091/0121/0151/0181) - Spigot diameter 200mm
<a href="#">TCB-SF80C6BE</a>	Spigot shaped flange - For models - (0241/0271/0301) - Spigot diameter 200mm
<a href="#">TCB-SF160C6BE</a>	Spigot shaped flange - For models - (0361/0481/0561) - Spigot diameter 200mm

\*All [Accessories](#) / [Controls](#)

Compatible R410a outdoor condensers:

**[Mini SMMS-e](#), [SMMS-u](#), [SHRM-e](#)**

Compatible R32 outdoor condensers:

**[Mini SMMS](#), [SHRM-a](#)**

Related items:

- [Full specification](#)
- [BIM files](#)
- [CAD files](#)
- [Airflow/ fan curve](#)
- [Dimensional drawing](#)
- [Wiring diagram](#)
- [Noise curve data](#)
- [Installation manual](#)

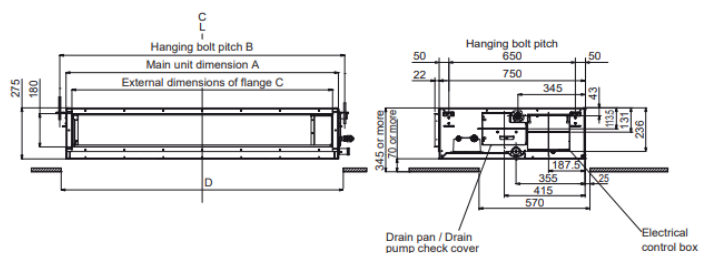

## VRF STANDARD DUCTED: MMD - UP0091BHP-E

- Air discharge spigot available as an option.
- External static pressure can be raised up to 150 Pa.
- With a depth of just 275mm helps to simplify the installation.
- Superior low noise operation. Noise output at low fan equates to just 23 dB(A).
- Can be configured between the standard rear inlet design or, from the underside of the unit.
- **Vertical conversion available upon request.**



Hi - Res Image 



### Performance Data

Capacity Code		HP	1.0
Nominal	Cooling Capacity	kW	2.8
	Heating Capacity	kW	3.2
UK	Cooling Total/Sensible	kW	2.5/2.1
	Heating	kW	2.2
Electrical	Power Input	kW	0.060
	Run Current	Amps	0.38
	Start Current	Amps	0.58

### Indoor Data

Airflow	High - Medium - Low	l/s	158 - 133 - 108
	High - Medium - Low	m3/h	570 - 480 - 390
External Static Pressure	Standard	Pa	30
	Maximum	Pa	150
Sound	Pressure High - Medium - Low	dB(A)	30 - 26 - 23
	Power High - Medium - Low	dB(A)	45 - 41 - 38
Unit	Height x Width x Depth (Horizontal)	mm	275 x 700 x 750
	Height x Width x Depth (Vertical)	mm	750 x 700 x 275
	Weight	kg	23
Pipe Connection	Flare Connections (gas - liquid)	inch	3/8 - 1/4
	Drain Pipe Connection OD/ID	mm	32/25
	Lift Pump Drain Height from Unit Base	mm	< 850
Power Supply	Suggested Fuse Size	V/ph/Hz-A	220-240/1/50-5

### Accessories

<a href="#">RBC-AMTU31-E</a>	Standard Remote Controller - Full control including service functions
<a href="#">RBC-ASCU11-E</a>	Compact Remote Controller - Includes timer off, back light display, multilingual
<a href="#">RBC-AWSU52-E</a>	Premium Controller - Includes timer and back light display, multilingual (inc. Bluetooth)
<a href="#">RBC-MTSC1</a>	Mini Touch Screen Controller - with configurable icons for indoor units
<a href="#">RBC-MTSC2</a>	Mini Touch Screen Controller - with Schedule Timer, configurable icons for indoor units
<a href="#">TCB-SF56C6BE</a>	Spigot shaped flange - For models - (0071/0091/0121/0151/0181) - Spigot diameter 200mm
<a href="#">TCB-SF80C6BE</a>	Spigot shaped flange - For models - (0241/0271/0301) - Spigot diameter 200mm
<a href="#">TCB-SF160C6BE</a>	Spigot shaped flange - For models - (0361/0481/0561) - Spigot diameter 200mm

\*All [Accessories](#) / [Controls](#)

Compatible R410a outdoor condensers:

**[Mini SMMS-e](#), [SMMS-u](#), [SHRM-e](#)**

Compatible R32 outdoor condensers:

**[Mini SMMS](#), [SHRM-a](#)**

Related items:

- [Full specification](#)
- [BIM files](#)
- [CAD files](#)
- [Airflow/ fan curve](#)
- [Dimensional drawing](#)
- [Wiring diagram](#)
- [Noise curve data](#)
- [Installation manual](#)

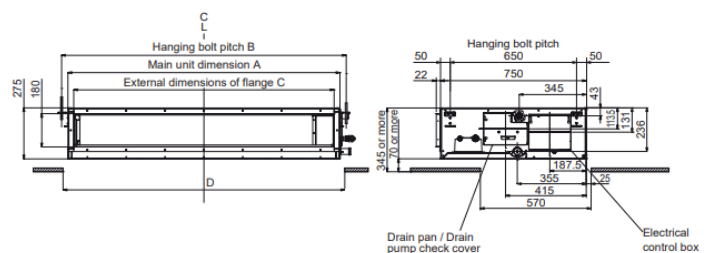

## VRF STANDARD DUCTED: MMD - UP0121BHP-E

- Air discharge spigot available as an option.
- External static pressure can be raised up to 150 Pa.
- With a depth of just 275mm helps to simplify the installation.
- Superior low noise operation. Noise output at low fan equates to just 23 dB(A).
- Can be configured between the standard rear inlet design or, from the underside of the unit.
- **Vertical conversion available upon request.**



Hi - Res Image 



### Performance Data

Capacity Code		HP	1.3
Nominal	Cooling Capacity	kW	3.6
	Heating Capacity	kW	4.0
UK	Cooling Total/Sensible	kW	3.2/2.4
	Heating	kW	2.7
Electrical	Power Input	kW	0.060
	Run Current	Amps	0.38
	Start Current	Amps	0.58

### Indoor Data

Airflow	High - Medium - Low	l/s	158 - 133 - 108
	High - Medium - Low	m <sup>3</sup> /h	570 - 480 - 390
External Static Pressure	Standard	Pa	30
	Maximum	Pa	150
Sound	Pressure High - Medium - Low	dB(A)	30 - 26 - 23
	Power High - Medium - Low	dB(A)	45 - 41 - 38
Unit	Height x Width x Depth (Horizontal)	mm	275 x 700 x 750
	Height x Width x Depth (Vertical)	mm	750 x 700 x 275
	Weight	kg	23
Pipe Connection	Flare Connections (gas - liquid)	inch	3/8 - 1/4
	Drain Pipe Connection OD/ID	mm	32/25
	Lift Pump Drain Height from Unit Base	mm	< 850
Power Supply	Suggested Fuse Size	V/ph/Hz-A	220-240/1/50-5

### Accessories

<a href="#">RBC-AMTU31-E</a>	Standard Remote Controller - Full control including service functions
<a href="#">RBC-ASCU11-E</a>	Compact Remote Controller - Includes timer off, back light display, multilingual
<a href="#">RBC-AWSU52-E</a>	Premium Controller - Includes timer and back light display, multilingual (inc. Bluetooth)
<a href="#">RBC-MTSC1</a>	Mini Touch Screen Controller - with configurable icons for indoor units
<a href="#">RBC-MTSC2</a>	Mini Touch Screen Controller - with Schedule Timer, configurable icons for indoor units
<a href="#">TCB-SF56C6BE</a>	Spigot shaped flange - For models - (0071/0091/0121/0151/0181) - Spigot diameter 200mm
<a href="#">TCB-SF80C6BE</a>	Spigot shaped flange - For models - (0241/0271/0301) - Spigot diameter 200mm
<a href="#">TCB-SF160C6BE</a>	Spigot shaped flange - For models - (0361/0481/0561) - Spigot diameter 200mm

\*All [Accessories](#) / [Controls](#)

Compatible R410a outdoor condensers:

**[Mini SMMS-e](#), [SMMS-u](#), [SHRM-e](#)**

Compatible R32 outdoor condensers:

**[Mini SMMS](#), [SHRM-a](#)**

Related items:

- [Full specification](#)
- [BIM files](#)
- [CAD files](#)
- [Airflow/ fan curve](#)
- [Dimensional drawing](#)
- [Wiring diagram](#)
- [Noise curve data](#)
- [Installation manual](#)

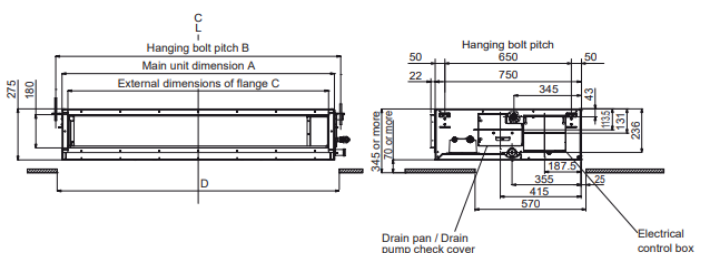

## VRF STANDARD DUCTED: MMD - UP0151BHP-E

- Air discharge spigot available as an option.
- External static pressure can be raised up to 150 Pa.
- With a depth of just 275mm helps to simplify the installation.
- Superior low noise operation. Noise output at low fan equates to just 25 dB(A).
- Can be configured between the standard rear inlet design or, from the underside of the unit.
- **Vertical conversion available upon request.**



Hi - Res Image 



### Performance Data

Capacity Code		HP	1.7
Nominal	Cooling Capacity	kW	4.5
	Heating Capacity	kW	5.0
UK	Cooling Total/Sensible	kW	4.0/3.3
	Heating	kW	3.4
Electrical	Power Input	kW	0.110
	Run Current	Amps	0.70
	Start Current	Amps	1.10

### Indoor Data

Airflow	High - Medium - Low	l/s	256 - 183 - 150
	High - Medium - Low	m3/h	920 - 660 - 540
External Static Pressure	Standard	Pa	30
	Maximum	Pa	150
Sound	Pressure High - Medium - Low	dB(A)	33 - 29 - 25
	Power High - Medium - Low	dB(A)	48 - 44 - 40
Unit	Height x Width x Depth (Horizontal)	mm	275 x 700 x 750
	Height x Width x Depth (Vertical)	mm	750 x 700 x 275
	Weight	kg	23
Pipe Connection	Flare Connections (gas - liquid)	inch	1/2 - 1/4
	Drain Pipe Connection OD/ID	mm	32/25
	Lift Pump Drain Height from Unit Base	mm	< 850
Power Supply	Suggested Fuse Size	V/ph/Hz-A	220-240/1/50-5

### Accessories

<a href="#">RBC-AMTU31-E</a>	Standard Remote Controller - Full control including service functions
<a href="#">RBC-ASCU11-E</a>	Compact Remote Controller - Includes timer off, back light display, multilingual
<a href="#">RBC-AWSU52-E</a>	Premium Controller - Includes timer and back light display, multilingual (inc. Bluetooth)
<a href="#">RBC-MTSC1</a>	Mini Touch Screen Controller - with configurable icons for indoor units
<a href="#">RBC-MTSC2</a>	Mini Touch Screen Controller - with Schedule Timer, configurable icons for indoor units
<a href="#">TCB-SF56C6BE</a>	Spigot shaped flange - For models - (0071/0091/0121/0151/0181) - Spigot diameter 200mm
<a href="#">TCB-SF80C6BE</a>	Spigot shaped flange - For models - (0241/0271/0301) - Spigot diameter 200mm
<a href="#">TCB-SF160C6BE</a>	Spigot shaped flange - For models - (0361/0481/0561) - Spigot diameter 200mm

\*All [Accessories](#) / [Controls](#)

Compatible R410a outdoor condensers:

**[Mini SMMS-e](#), [SMMS-u](#), [SHRM-e](#)**

Compatible R32 outdoor condensers:

**[Mini SMMS](#), [SHRM-a](#)**

Related items:

- [Full specification](#)
- [BIM files](#)
- [CAD files](#)
- [Airflow/ fan curve](#)
- [Dimensional drawing](#)
- [Wiring diagram](#)
- [Noise curve data](#)
- [Installation manual](#)

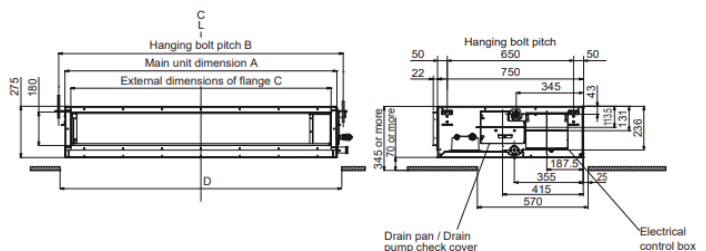



## VRF STANDARD DUCTED: MMD - UP0181BHP-E

- Air discharge spigot available as an option.
- External static pressure can be raised up to 150 Pa.
- With a depth of just 275mm helps to simplify the installation.
- Superior low noise operation. Noise output at low fan equates to just 25 dB(A).
- Can be configured between the standard rear inlet design or, from the underside of the unit.
- **Vertical conversion available upon request.**



Hi - Res Image 



### Performance Data

Capacity Code		HP	2.0
Nominal	Cooling Capacity	kW	5.6
	Heating Capacity	kW	6.3
UK	Cooling Total/Sensible	kW	5.0/3.7
	Heating	kW	4.3
Electrical	Power Input	kW	0.110
	Run Current	Amps	0.70
	Start Current	Amps	1.10

### Indoor Data

Airflow	High - Medium - Low	l/s	256 - 183 - 150
	High - Medium - Low	m3/h	920 - 660 - 540
External Static Pressure	Standard	Pa	30
	Maximum	Pa	150
Sound	Pressure High - Medium - Low	dB(A)	33 - 29 - 25
	Power High - Medium - Low	dB(A)	48 - 44 - 40
Unit	Height x Width x Depth (Horizontal)	mm	275 x 700 x 750
	Height x Width x Depth (Vertical)	mm	750 x 700 x 275
	Weight	kg	23
Pipe Connection	Flare Connections (gas - liquid)	inch	1/2 - 1/4
	Drain Pipe Connection OD/ID	mm	32/25
	Lift Pump Drain Height from Unit Base	mm	< 850
Power Supply	Suggested Fuse Size	V/ph/Hz-A	220-240/1/50-5

### Accessories

<a href="#">RBC-AMTU31-E</a>	Standard Remote Controller - Full control including service functions
<a href="#">RBC-ASCU11-E</a>	Compact Remote Controller - Includes timer off, back light display, multilingual
<a href="#">RBC-AWSU52-E</a>	Premium Controller - Includes timer and back light display, multilingual (inc. Bluetooth)
<a href="#">RBC-MTSC1</a>	Mini Touch Screen Controller - with configurable icons for indoor units
<a href="#">RBC-MTSC2</a>	Mini Touch Screen Controller - with Schedule Timer, configurable icons for indoor units
<a href="#">TCB-SF56C6BE</a>	Spigot shaped flange - For models - (0071/0091/0121/0151/0181) - Spigot diameter 200mm
<a href="#">TCB-SF80C6BE</a>	Spigot shaped flange - For models - (0241/0271/0301) - Spigot diameter 200mm
<a href="#">TCB-SF160C6BE</a>	Spigot shaped flange - For models - (0361/0481/0561) - Spigot diameter 200mm

\*All [Accessories](#) / [Controls](#)

Compatible R410a outdoor condensers:

**[Mini SMMS-e](#), [SMMS-u](#), [SHRM-e](#)**

Compatible R32 outdoor condensers:

**[Mini SMMS](#), [SHRM-a](#)**

Related items:

- [Full specification](#)
- [BIM files](#)
- [CAD files](#)
- [Airflow/ fan curve](#)
- [Dimensional drawing](#)
- [Wiring diagram](#)
- [Noise curve data](#)
- [Installation manual](#)

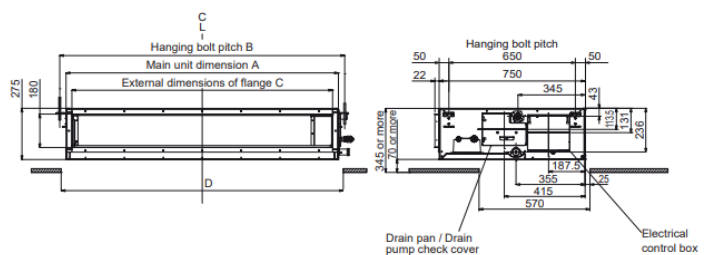

## VRF STANDARD DUCTED: MMD - UP0241BHP-E

- Air discharge spigot available as an option.
- External static pressure can be raised up to 150 Pa.
- With a depth of just 275mm helps to simplify the installation.
- Superior low noise operation. Noise output at low fan equates to just 27 dB(A).
- Can be configured between the standard rear inlet design or, from the underside of the unit.
- **Vertical conversion available upon request.**



Hi - Res Image 



### Performance Data

Capacity Code		HP	2.5
Nominal	Cooling Capacity	kW	7.1
	Heating Capacity	kW	8.0
UK	Cooling Total/Sensible	kW	6.3/4.8
	Heating	kW	5.4
Electrical	Power Input	kW	0.135
	Run Current	Amps	0.80
	Start Current	Amps	1.20

### Indoor Data

Airflow	High - Medium - Low	l/s	3667 - 303 - 242
	High - Medium - Low	m <sup>3</sup> /h	1320 - 1090 - 870
External Static Pressure	Standard	Pa	40
	Maximum	Pa	150
Sound	Pressure High - Medium - Low	dB(A)	33 - 30 - 27
	Power High - Medium - Low	dB(A)	51 - 46 - 42
Unit	Height x Width x Depth (Horizontal)	mm	275 x 1000 x 750
	Height x Width x Depth (Vertical)	mm	750 x 1000 x 275
	Weight	kg	30
Pipe Connection	Flare Connections (gas - liquid)	inch	5/8 - 3/8
	Drain Pipe Connection OD/ID	mm	32/25
	Lift Pump Drain Height from Unit Base	mm	< 850
Power Supply	Suggested Fuse Size	V/ph/Hz-A	220-240/1/50-5

### Accessories

<a href="#">RBC-AMTU31-E</a>	Standard Remote Controller - Full control including service functions
<a href="#">RBC-ASCU11-E</a>	Compact Remote Controller - Includes timer off, back light display, multilingual
<a href="#">RBC-AWSU52-E</a>	Premium Controller - Includes timer and back light display, multilingual (inc. Bluetooth)
<a href="#">RBC-MTSC1</a>	Mini Touch Screen Controller - with configurable icons for indoor units
<a href="#">RBC-MTSC2</a>	Mini Touch Screen Controller - with Schedule Timer, configurable icons for indoor units
<a href="#">TCB-SF56C6BE</a>	Spigot shaped flange - For models - (0071/0091/0121/0151/0181) - Spigot diameter 200mm
<a href="#">TCB-SF80C6BE</a>	Spigot shaped flange - For models - (0241/0271/0301) - Spigot diameter 200mm
<a href="#">TCB-SF160C6BE</a>	Spigot shaped flange - For models - (0361/0481/0561) - Spigot diameter 200mm

\*All [Accessories](#) / [Controls](#)

Compatible R410a outdoor condensers:

**[Mini SMMS-e](#), [SMMS-u](#), [SHRM-e](#)**

Compatible R32 outdoor condensers:

**[Mini SMMS](#), [SHRM-a](#)**

Related items:

- [Full specification](#)
- [BIM files](#)
- [CAD files](#)
- [Airflow/ fan curve](#)
- [Dimensional drawing](#)
- [Wiring diagram](#)
- [Noise curve data](#)
- [Installation manual](#)

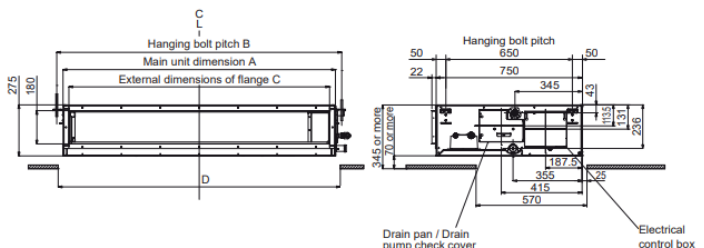

## VRF STANDARD DUCTED: MMD - UP0271BHP-E

- Air discharge spigot available as an option.
- External static pressure can be raised up to 150 Pa.
- With a depth of just 275mm helps to simplify the installation.
- Superior low noise operation. Noise output at low fan equates to just 27 dB(A).
- Can be configured between the standard rear inlet design or, from the underside of the unit.
- **Vertical conversion available upon request.**



Hi - Res Image 



### Performance Data

Capacity Code		HP	3.0
Nominal	Cooling Capacity	kW	8.0
	Heating Capacity	kW	9.0
UK	Cooling Total/Sensible	kW	7.1/5.4
	Heating	kW	6.1
Electrical	Power Input	kW	0.135
	Run Current	Amps	0.80
	Start Current	Amps	1.20

### Indoor Data

Airflow	High - Medium - Low	l/s	3667 - 303 - 242
	High - Medium - Low	m <sup>3</sup> /h	1320 - 1090 - 870
External Static Pressure	Standard	Pa	40
	Maximum	Pa	150
Sound	Pressure High - Medium - Low	dB(A)	33 - 30 - 27
	Power High - Medium - Low	dB(A)	51 - 46 - 42
Unit	Height x Width x Depth (Horizontal)	mm	275 x 1000 x 750
	Height x Width x Depth (Vertical)	mm	750 x 1000 x 275
	Weight	kg	30
Pipe Connection	Flare Connections (gas - liquid)	inch	5/8 - 3/8
	Drain Pipe Connection OD/ID	mm	32/25
	Lift Pump Drain Height from Unit Base	mm	< 850
Power Supply	Suggested Fuse Size	V/ph/Hz-A	220-240/1/50-5

### Accessories

<a href="#">RBC-AMTU31-E</a>	Standard Remote Controller - Full control including service functions
<a href="#">RBC-ASCU11-E</a>	Compact Remote Controller - Includes timer off, back light display, multilingual
<a href="#">RBC-AWSU52-E</a>	Premium Controller - Includes timer and back light display, multilingual (inc. Bluetooth)
<a href="#">RBC-MTSC1</a>	Mini Touch Screen Controller - with configurable icons for indoor units
<a href="#">RBC-MTSC2</a>	Mini Touch Screen Controller - with Schedule Timer, configurable icons for indoor units
<a href="#">TCB-SF56C6BE</a>	Spigot shaped flange - For models - (0071/0091/0121/0151/0181) - Spigot diameter 200mm
<a href="#">TCB-SF80C6BE</a>	Spigot shaped flange - For models - (0241/0271/0301) - Spigot diameter 200mm
<a href="#">TCB-SF160C6BE</a>	Spigot shaped flange - For models - (0361/0481/0561) - Spigot diameter 200mm

\*All [Accessories](#) / [Controls](#)

Compatible R410a outdoor condensers:

**[Mini SMMS-e](#), [SMMS-u](#), [SHRM-e](#)**

Compatible R32 outdoor condensers:

**[Mini SMMS](#), [SHRM-a](#)**

Related items:

- [Full specification](#)
- [BIM files](#)
- [CAD files](#)
- [Airflow/ fan curve](#)
- [Dimensional drawing](#)
- [Wiring diagram](#)
- [Noise curve data](#)
- [Installation manual](#)

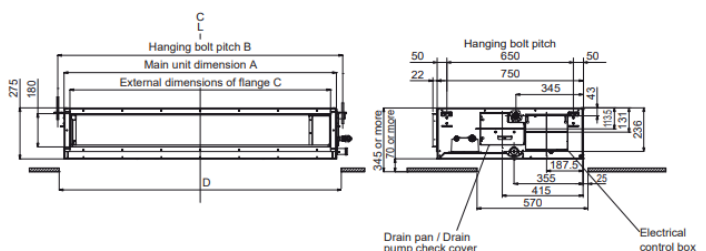

## VRF STANDARD DUCTED: MMD - UP0301BHP-E

- Air discharge spigot available as an option.
- External static pressure can be raised up to 150 Pa.
- With a depth of just 275mm helps to simplify the installation.
- Superior low noise operation. Noise output at low fan equates to just 27 dB(A).
- Can be configured between the standard rear inlet design or, from the underside of the unit.
- **Vertical conversion available upon request.**



Hi - Res Image 



### Performance Data

Capacity Code		HP	3.2
Nominal	Cooling Capacity	kW	9.0
	Heating Capacity	kW	10.0
UK	Cooling Total/Sensible	kW	8.0/6.1
	Heating	kW	6.8
Electrical	Power Input	kW	0.160
	Run Current	Amps	0.95
	Start Current	Amps	1.35

### Indoor Data

Airflow	High - Medium - Low	l/s	403 - 333 - 267
	High - Medium - Low	m <sup>3</sup> /h	1450 - 1200 - 960
External Static Pressure	Standard	Pa	40
	Maximum	Pa	150
Sound	Pressure High - Medium - Low	dB(A)	36 - 31 - 27
	Power High - Medium - Low	dB(A)	51 - 46 - 42
Unit	Height x Width x Depth (Horizontal)	mm	275 x 1000 x 750
	Height x Width x Depth (Vertical)	mm	750 x 1000 x 275
	Weight	kg	30
Pipe Connection	Flare Connections (gas - liquid)	inch	5/8 - 3/8
	Drain Pipe Connection OD/ID	mm	32/25
	Lift Pump Drain Height from Unit Base	mm	< 850
Power Supply	Suggested Fuse Size	V/ph/Hz-A	220-240/1/50-5

### Accessories

<a href="#">RBC-AMTU31-E</a>	Standard Remote Controller - Full control including service functions
<a href="#">RBC-ASCU11-E</a>	Compact Remote Controller - Includes timer off, back light display, multilingual
<a href="#">RBC-AWSU52-E</a>	Premium Controller - Includes timer and back light display, multilingual (inc. Bluetooth)
<a href="#">RBC-MTSC1</a>	Mini Touch Screen Controller - with configurable icons for indoor units
<a href="#">RBC-MTSC2</a>	Mini Touch Screen Controller - with Schedule Timer, configurable icons for indoor units
<a href="#">TCB-SF56C6BE</a>	Spigot shaped flange - For models - (0071/0091/0121/0151/0181) - Spigot diameter 200mm
<a href="#">TCB-SF80C6BE</a>	Spigot shaped flange - For models - (0241/0271/0301) - Spigot diameter 200mm
<a href="#">TCB-SF160C6BE</a>	Spigot shaped flange - For models - (0361/0481/0561) - Spigot diameter 200mm

\*All [Accessories](#) / [Controls](#)

Compatible R410a outdoor condensers:

**[Mini SMMS-e](#), [SMMS-u](#), [SHRM-e](#)**

Compatible R32 outdoor condensers:

**[Mini SMMS](#), [SHRM-a](#)**

Related items:

- [Full specification](#)
- [BIM files](#)
- [CAD files](#)
- [Airflow/ fan curve](#)
- [Dimensional drawing](#)
- [Wiring diagram](#)
- [Noise curve data](#)
- [Installation manual](#)

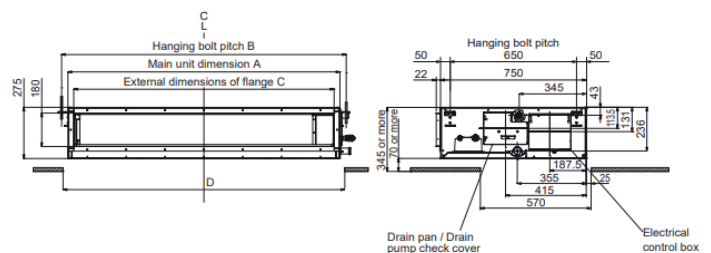

## VRF STANDARD DUCTED: MMD - UP0361BHP-E

- Air discharge spigot available as an option.
- External static pressure can be raised up to 150 Pa.
- With a depth of just 275mm helps to simplify the installation.
- Superior low noise operation. Noise output at low fan equates to just 31 dB(A).
- Can be configured between the standard rear inlet design or, from the underside of the unit.
- **Vertical conversion available upon request.**



Hi - Res Image 



### Performance Data

Capacity Code		HP	4.0
Nominal	Cooling Capacity	kW	11.2
	Heating Capacity	kW	12.5
UK	Cooling Total/Sensible	kW	10.0/7.7
	Heating	kW	8.5
Electrical	Power Input	kW	0.220
	Run Current	Amps	1.29
	Start Current	Amps	2.09

### Indoor Data

Airflow	High - Medium - Low	l/s	533 - 450 - 383
	High - Medium - Low	m <sup>3</sup> /h	1920 - 1620 - 1380
External Static Pressure	Standard	Pa	50
	Maximum	Pa	150
Sound	Pressure High - Medium - Low	dB(A)	36 - 34 - 31
	Power High - Medium - Low	dB(A)	55 - 51 - 48
Unit	Height x Width x Depth (Horizontal)	mm	275 x 1400 x 750
	Height x Width x Depth (Vertical)	mm	750 x 1000 x 275
	Weight	kg	40
Pipe Connection	Flare Connections (gas - liquid)	inch	5/8 - 3/8
	Drain Pipe Connection OD/ID	mm	32/25
	Lift Pump Drain Height from Unit Base	mm	< 850
Power Supply	Suggested Fuse Size	V/ph/Hz-A	220-240/1/50-5

### Accessories

<a href="#">RBC-AMTU31-E</a>	Standard Remote Controller - Full control including service functions
<a href="#">RBC-ASCU11-E</a>	Compact Remote Controller - Includes timer off, back light display, multilingual
<a href="#">RBC-AWSU52-E</a>	Premium Controller - Includes timer and back light display, multilingual (inc. Bluetooth)
<a href="#">RBC-MTSC1</a>	Mini Touch Screen Controller - with configurable icons for indoor units
<a href="#">RBC-MTSC2</a>	Mini Touch Screen Controller - with Schedule Timer, configurable icons for indoor units
<a href="#">TCB-SF56C6BE</a>	Spigot shaped flange - For models - (0071/0091/0121/0151/0181) - Spigot diameter 200mm
<a href="#">TCB-SF80C6BE</a>	Spigot shaped flange - For models - (0241/0271/0301) - Spigot diameter 200mm
<a href="#">TCB-SF160C6BE</a>	Spigot shaped flange - For models - (0361/0481/0561) - Spigot diameter 200mm

\*All [Accessories](#) / [Controls](#)

Compatible R410a outdoor condensers:

**[Mini SMMS-e](#), [SMMS-u](#), [SHRM-e](#)**

Compatible R32 outdoor condensers:

**[Mini SMMS](#), [SHRM-a](#)**

Related items:

- [Full specification](#)
- [BIM files](#)
- [CAD files](#)
- [Airflow/ fan curve](#)
- [Dimensional drawing](#)
- [Wiring diagram](#)
- [Noise curve data](#)
- [Installation manual](#)

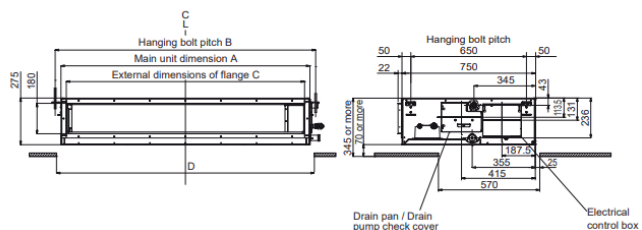

## VRF STANDARD DUCTED: MMD - UP0481BHP-E

- Air discharge spigot available as an option.
- External static pressure can be raised up to 150 Pa.
- With a depth of just 275mm helps to simplify the installation.
- Superior low noise operation. Noise output at low fan equates to just 33 dB(A).
- Can be configured between the standard rear inlet design or, from the underside of the unit.
- **Vertical conversion available upon request.**



Hi - Res Image



### Performance Data

Capacity Code		HP	5.0
Nominal	Cooling Capacity	kW	14.0
	Heating Capacity	kW	16.0
UK	Cooling Total/Sensible	kW	12.3/9.2
	Heating	kW	10.9
	Power Input	kW	0.290
Electrical	Run Current	Amps	1.70
	Start Current	Amps	2.50

### Indoor Data

Airflow	High - Medium - Low	l/s	653 - 533 - 417
	High - Medium - Low	m3/h	2350 - 1920 - 1500
External Static Pressure	Standard	Pa	50
	Maximum	Pa	150
Sound	Pressure High - Medium - Low	dB(A)	40 - 36 - 33
	Power High - Medium - Low	dB(A)	55 - 51 - 48
Unit	Height x Width x Depth (Horizontal)	mm	275 x 1400 x 750
	Height x Width x Depth (Vertical)	mm	750 x 1400 x 275
	Weight	kg	40
Pipe Connection	Flare Connections (gas - liquid)	inch	5/8 - 3/8
	Drain Pipe Connection OD/ID	mm	32/25
	Lift Pump Drain Height from Unit Base	mm	< 850
Power Supply	Suggested Fuse Size	V/ph/Hz-A	220-240/1/50-5

### Accessories

<a href="#">RBC-AMTU31-E</a>	Standard Remote Controller - Full control including service functions
<a href="#">RBC-ASCU11-E</a>	Compact Remote Controller - Includes timer off, back light display, multilingual
<a href="#">RBC-AWSU52-E</a>	Premium Controller - Includes timer and back light display, multilingual (inc. Bluetooth)
<a href="#">RBC-MTSC1</a>	Mini Touch Screen Controller - with configurable icons for indoor units
<a href="#">RBC-MTSC2</a>	Mini Touch Screen Controller - with Schedule Timer, configurable icons for indoor units
<a href="#">TCB-SF56C6BE</a>	Spigot shaped flange - For models - (0071/0091/0121/0151/0181) - Spigot diameter 200mm
<a href="#">TCB-SF80C6BE</a>	Spigot shaped flange - For models - (0241/0271/0301) - Spigot diameter 200mm
<a href="#">TCB-SF160C6BE</a>	Spigot shaped flange - For models - (0361/0481/0561) - Spigot diameter 200mm

\*All [Accessories](#) / [Controls](#)

Compatible R410a outdoor condensers:

**[Mini SMMS-e](#), [SMMS-u](#), [SHRM-e](#)**

Compatible R32 outdoor condensers:

**[Mini SMMS](#), [SHRM-a](#)**

Related items:

- [Full specification](#)
- [BIM files](#)
- [CAD files](#)
- [Airflow/ fan curve](#)
- [Dimensional drawing](#)
- [Wiring diagram](#)
- [Noise curve data](#)
- [Installation manual](#)

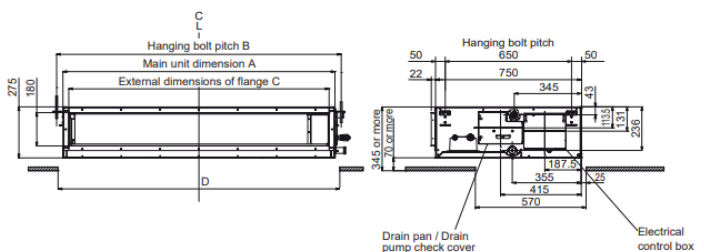

## VRF STANDARD DUCTED: MMD - UP0561BHP-E

- Air discharge spigot available as an option.
- External static pressure can be raised up to 150 Pa.
- With a depth of just 275mm helps to simplify the installation.
- Superior low noise operation. Noise output at low fan equates to just 3 dB(A).
- Can be configured between the standard rear inlet design or, from the underside of the unit.
- **Vertical conversion available upon request.**

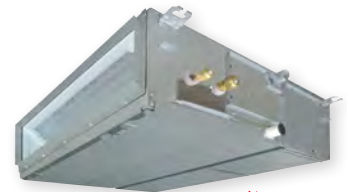

Hi - Res Image 



Performance Data			
Capacity Code		HP	6.0
Nominal	Cooling Capacity	kW	16.0
	Heating Capacity	kW	18.0
UK	Cooling Total/Sensible	kW	14.3/10.2
	Heating	kW	12.2
Electrical	Power Input	kW	0.290
	Run Current	Amps	1.70
	Start Current	Amps	2.50

Indoor Data			
Airflow	High - Medium - Low	l/s	653 - 533 - 417
	High - Medium - Low	m3/h	2350 - 1920 - 1500
External Static Pressure	Standard	Pa	50
	Maximum	Pa	150
Sound	Pressure High - Medium - Low	dB(A)	40 - 36 - 33
	Power High - Medium - Low	dB(A)	55 - 51 - 48
Unit	Height x Width x Depth (Horizontal)	mm	275 x 1400 x 750
	Height x Width x Depth (Vertical)	mm	750 x 1400 x 275
	Weight	kg	40
Pipe Connection	Flare Connections (gas - liquid)	inch	5/8 - 3/8
	Drain Pipe Connection OD/ID	mm	32/25
	Lift Pump Drain Height from Unit Base	mm	< 850
Power Supply	Suggested Fuse Size	V/ph/Hz-A	220-240/1/50-5

Accessories	
<a href="#">RBC-AMTU31-E</a>	Standard Remote Controller - Full control including service functions
<a href="#">RBC-ASCU11-E</a>	Compact Remote Controller - Includes timer off, back light display, multilingual
<a href="#">RBC-AWSU52-E</a>	Premium Controller - Includes timer and back light display, multilingual (inc. Bluetooth)
<a href="#">RBC-MTSC1</a>	Mini Touch Screen Controller - with configurable icons for indoor units
<a href="#">RBC-MTSC2</a>	Mini Touch Screen Controller - with Schedule Timer, configurable icons for indoor units
<a href="#">TCB-SF56C6BE</a>	Spigot shaped flange - For models - (0071/0091/0121/0151/0181) - Spigot diameter 200mm
<a href="#">TCB-SF80C6BE</a>	Spigot shaped flange - For models - (0241/0271/0301) - Spigot diameter 200mm
<a href="#">TCB-SF160C6BE</a>	Spigot shaped flange - For models - (0361/0481/0561) - Spigot diameter 200mm

\*All [Accessories](#) / [Controls](#)

Compatible R410a outdoor condensers:

**[Mini SMMS-e](#), [SMMS-u](#), [SHRM-e](#)**

Compatible R32 outdoor condensers:

**[Mini SMMS](#), [SHRM-a](#)**

Related items:

- [Full specification](#)
- [BIM files](#)
- [CAD files](#)
- [Airflow/ fan curve](#)
- [Dimensional drawing](#)
- [Wiring diagram](#)
- [Noise curve data](#)
- [Installation manual](#)

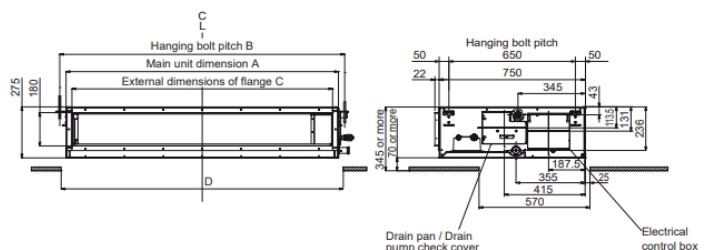

# HIGH STATIC DUCTED





## VRF HIGH STATIC DUCTED: MMD - UP0181HP-E

- Unobtrusive, flexible and compact (298mm depth).
- Static pressure can be set to 6 levels from 50 to 200Pa.
- Long-life filter and air discharge spigot available as an option.
- Toshiba's most powerful ducted unit delivering air flows up to 1100m<sup>3</sup>/h.
- Diffuser design flexibility to select the right layout for the room shape / end user requirements.



Hi - Res Image 



### Performance Data

Capacity Code		HP	2.0
Nominal	Cooling Capacity	kW	5.6
	Heating Capacity	kW	6.3
UK	Cooling Total/Sensible	kW	5.1/3.7
	Heating	kW	4.3
Electrical	Power Input	kW	0.125
	Run Current	Amps	0.82
	Start Current	Amps	1.12

### Indoor Data

Airflow	High - Medium - Low	l/s	306 - 275 - 250
	High - Medium - Low	m <sup>3</sup> /h	1100 - 990 - 900
External Static Pressure	Standard	Pa	100
	Maximum	Pa	200
Sound	Pressure High - Medium - Low	dB(A)	37 - 33 - 31
	Power High - Medium - Low	dB(A)	52 - 48 - 46
Unit	Height x Width x Depth	mm	298 x 1000 x 750
	Weight	kg	34
Pipe Connection	Flare Connections (gas - liquid)	inch	1/2 - 1/4
	Drain Pipe Connection OD/ID	mm	32/25
Power Supply	Suggested Fuse Size	V/ph/Hz-A	220-240/1/50-10

### Accessories

<a href="#">RBC-AMTU31-E</a>	Standard Remote Controller - Full control including service functions
<a href="#">RBC-ASCU11-E</a>	Compact Remote Controller - Includes timer off, back light display, multilingual
<a href="#">RBC-AWSU52-E</a>	Premium Controller - Includes timer and back light display, multilingual (inc. Bluetooth)
<a href="#">RBC-MTSC1</a>	Mini Touch Screen Controller - with configurable icons for indoor units
<a href="#">RBC-MTSC2</a>	Mini Touch Screen Controller - with Schedule Timer, configurable icons for indoor units
<a href="#">TCB-SF80C6BE</a>	Spigot shaped flange - For models - (0181/0241/0271) - Spigot diameter 200mm
<a href="#">TCB-LK801D-E</a>	Long Life Filter Kits - For use with - (0181/0241/0271)
<a href="#">TCB-FF151US-E</a>	Auxiliary Fresh Air Flange - for use with - (all models)

\*All [Accessories / Controls](#)

Compatible R410a outdoor condensers:

**[Mini SMMS-e](#), [SMMS-u](#), [SHRM-e](#)**

Compatible R32 outdoor condensers:

**[Mini SMMS](#), [SHRM-a](#)**

Related items:

- [Full specification](#)
- [BIM files](#)
- [CAD files](#)
- [Airflow/ fan curve](#)
- [Dimensional drawing](#)
- [Wiring diagram](#)
- [Noise curve data](#)
- [Installation manual](#)

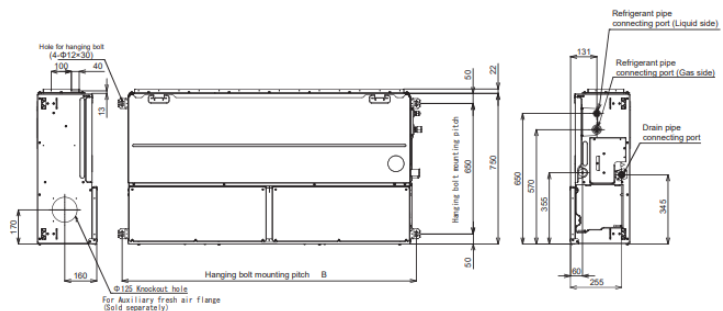

## VRF HIGH STATIC DUCTED: MMD - UP0241HP-E

- Unobtrusive, flexible and compact (298mm depth).
- Static pressure can be set to 6 levels from 50 to 200Pa.
- Long-life filter and air discharge spigot available as an option.
- Toshiba's most powerful ducted unit delivering air flows up to 1200m<sup>3</sup>/h.
- Diffuser design flexibility to select the right layout for the room shape / end user requirements.



Hi - Res Image 



### Performance Data

Capacity Code		HP	2.5
Nominal	Cooling Capacity	kW	7.1
	Heating Capacity	kW	8.0
UK	Cooling Total/Sensible	kW	6.4/4.9
	Heating	kW	5.4
Electrical	Power Input	kW	0.140
	Run Current	Amps	0.92
	Start Current	Amps	1.22

### Indoor Data

Airflow	High - Medium - Low	l/s	333 - 292 - 267
	High - Medium - Low	m <sup>3</sup> /h	1200 - 1050 - 960
External Static Pressure	Standard	Pa	100
	Maximum	Pa	200
Sound	Pressure High - Medium - Low	dB(A)	38 - 34 - 31
	Power High - Medium - Low	dB(A)	53 - 49 - 46
Unit	Height x Width x Depth	mm	298 x 1000 x 750
	Weight	kg	34
Pipe Connection	Flare Connections (gas - liquid)	inch	5/8 - 3/8
	Drain Pipe Connection OD/ID	mm	32/25
Power Supply	Suggested Fuse Size	V/ph/Hz-A	220-240/1/50-10

### Accessories

<a href="#">RBC-AMTU31-E</a>	Standard Remote Controller - Full control including service functions
<a href="#">RBC-ASCU11-E</a>	Compact Remote Controller - Includes timer off, back light display, multilingual
<a href="#">RBC-AWSU52-E</a>	Premium Controller - Includes timer and back light display, multilingual (inc. Bluetooth)
<a href="#">RBC-MTSC1</a>	Mini Touch Screen Controller - with configurable icons for indoor units
<a href="#">RBC-MTSC2</a>	Mini Touch Screen Controller - with Schedule Timer, configurable icons for indoor units
<a href="#">TCB-SF80C6BE</a>	Spigot shaped flange - For models - (0181/0241/0271) - Spigot diameter 200mm
<a href="#">TCB-LK801D-E</a>	Long Life Filter Kits - For use with - (0181/0241/0271)
<a href="#">TCB-FF151US-E</a>	Auxiliary Fresh Air Flange - for use with - (all models)

\*All [Accessories](#) / [Controls](#)

Compatible R410a outdoor condensers:

**[Mini SMMS-e](#), [SMMS-u](#), [SHRM-e](#)**

Compatible R32 outdoor condensers:

**[Mini SMMS](#), [SHRM-a](#)**

Related items:

- [Full specification](#)
- [BIM files](#)
- [CAD files](#)
- [Airflow/ fan curve](#)
- [Dimensional drawing](#)
- [Wiring diagram](#)
- [Noise curve data](#)
- [Installation manual](#)

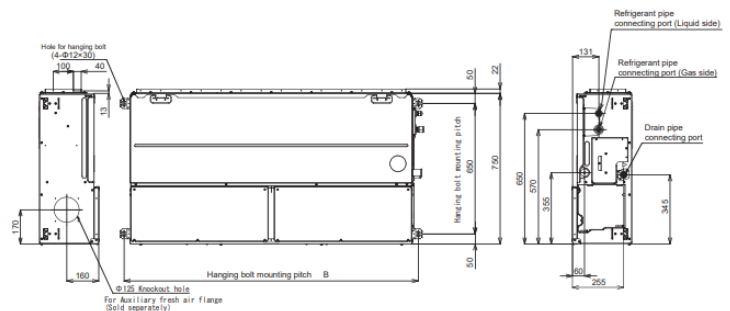

## VRF HIGH STATIC DUCTED: MMD - UP0271HP-E

- Unobtrusive, flexible and compact (298mm depth).
- Static pressure can be set to 6 levels from 50 to 200Pa.
- Long-life filter and air discharge spigot available as an option.
- Toshiba's most powerful ducted unit delivering air flows up to 1500m<sup>3</sup>/h.
- Diffuser design flexibility to select the right layout for the room shape / end user requirements.



Hi - Res Image 



### Performance Data

Capacity Code		HP	3.0
Nominal	Cooling Capacity	kW	8.0
	Heating Capacity	kW	9.0
UK	Cooling Total/Sensible	kW	7.3/5.5
	Heating	kW	6.1
	Power Input	kW	0.190
Electrical	Run Current	Amps	1.16
	Start Current	Amps	1.46

### Indoor Data

Airflow	High - Medium - Low	l/s	417 - 375 - 333
	High - Medium - Low	m <sup>3</sup> /h	1500 - 1350 - 1200
External Static Pressure	Standard	Pa	100
	Maximum	Pa	200
Sound	Pressure High - Medium - Low	dB(A)	43 - 41 - 38
	Power High - Medium - Low	dB(A)	58 - 56 - 53
Unit	Height x Width x Depth	mm	298 x 1000 x 750
	Weight	kg	34
Pipe Connection	Flare Connections (gas - liquid)	inch	5/8 - 3/8
	Drain Pipe Connection OD/ID	mm	32/25
Power Supply	Suggested Fuse Size	V/ph/Hz-A	220-240/1/50-10

### Accessories

<a href="#">RBC-AMTU31-E</a>	Standard Remote Controller - Full control including service functions
<a href="#">RBC-ASCU11-E</a>	Compact Remote Controller - Includes timer off, back light display, multilingual
<a href="#">RBC-AWSU52-E</a>	Premium Controller - Includes timer and back light display, multilingual (inc. Bluetooth)
<a href="#">RBC-MTSC1</a>	Mini Touch Screen Controller - with configurable icons for indoor units
<a href="#">RBC-MTSC2</a>	Mini Touch Screen Controller - with Schedule Timer, configurable icons for indoor units
<a href="#">TCB-SF80C6BE</a>	Spigot shaped flange - For models - (0181/0241/0271) - Spigot diameter 200mm
<a href="#">TCB-LK801D-E</a>	Long Life Filter Kits - For use with - (0181/0241/0271)
<a href="#">TCB-FF151US-E</a>	Auxiliary Fresh Air Flange - for use with - (all models)

\*All [Accessories / Controls](#)

Compatible R410a outdoor condensers:

**[Mini SMMS-e](#), [SMMS-u](#), [SHRM-e](#)**

Compatible R32 outdoor condensers:

**[Mini SMMS](#), [SHRM-a](#)**

Related items:

- [Full specification](#)
- [BIM files](#)
- [CAD files](#)
- [Airflow/ fan curve](#)
- [Dimensional drawing](#)
- [Wiring diagram](#)
- [Noise curve data](#)
- [Installation manual](#)

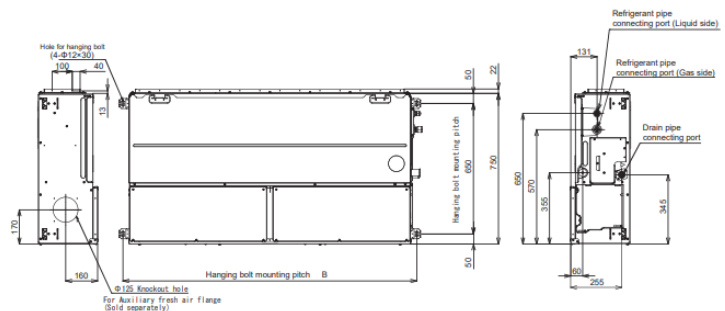

## VRF HIGH STATIC DUCTED: MMD - UP0361HP-E

- Unobtrusive, flexible and compact (298mm depth).
- Static pressure can be set to 6 levels from 50 to 200Pa.
- Long-life filter and air discharge spigot available as an option.
- Toshiba's most powerful ducted unit delivering air flows up to 19200m<sup>3</sup>/h.
- Diffuser design flexibility to select the right layout for the room shape / end user requirements.



Hi - Res Image 



### Performance Data

Capacity Code		HP	4.0
Nominal	Cooling Capacity	kW	11.2
	Heating Capacity	kW	12.5
UK	Cooling Total/Sensible	kW	10.2/7.8
	Heating	kW	8.5
	Power Input	kW	0.230
Electrical	Run Current	Amps	1.39
	Start Current	Amps	1.89

### Indoor Data

Airflow	High - Medium - Low	l/s	533 - 433 - 372
	High - Medium - Low	m <sup>3</sup> /h	1920 - 1560 - 1340
External Static Pressure	Standard	Pa	100
	Maximum	Pa	200
Sound	Pressure High - Medium - Low	dB(A)	41 - 37 - 34
	Power High - Medium - Low	dB(A)	56 - 52 - 49
Unit	Height x Width x Depth	mm	298 x 1400 x 750
	Weight	kg	43
Pipe Connection	Flare Connections (gas - liquid)	inch	5/8 - 3/8
	Drain Pipe Connection OD/ID	mm	32/25
Power Supply	Suggested Fuse Size	V/ph/Hz-A	220-240/1/50-10

### Accessories

<a href="#">RBC-AMTU31-E</a>	Standard Remote Controller - Full control including service functions
<a href="#">RBC-ASCU11-E</a>	Compact Remote Controller - Includes timer off, back light display, multilingual
<a href="#">RBC-AWSU52-E</a>	Premium Controller - Includes timer and back light display, multilingual (inc. Bluetooth)
<a href="#">RBC-MTSC1</a>	Mini Touch Screen Controller - with configurable icons for indoor units
<a href="#">RBC-MTSC2</a>	Mini Touch Screen Controller - with Schedule Timer, configurable icons for indoor units
<a href="#">TCB-SF160C6BE</a>	Spigot shaped flange - For models - (0361/0481/0561) - Spigot diameter 200mm
<a href="#">TCB-LK1401D-E</a>	Long Life Filter Kits - For use with - (0361/0481/0561)
<a href="#">TCB-FF151US-E</a>	Auxiliary Fresh Air Flange - for use with - (all models)

\*All [Accessories](#) / [Controls](#)

Compatible R410a outdoor condensers:

**[Mini SMMS-e](#), [SMMS-u](#), [SHRM-e](#)**

Compatible R32 outdoor condensers:

**[Mini SMMS](#), [SHRM-a](#)**

Related items:

- [Full specification](#)
- [BIM files](#)
- [CAD files](#)
- [Airflow/ fan curve](#)
- [Dimensional drawing](#)
- [Wiring diagram](#)
- [Noise curve data](#)
- [Installation manual](#)

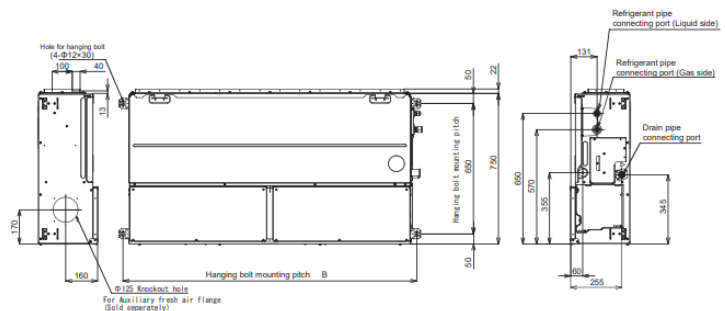

## VRF HIGH STATIC DUCTED: MMD - UP0481HP-E

- Unobtrusive, flexible and compact (298mm depth).
- Static pressure can be set to 6 levels from 50 to 200Pa.
- Long-life filter and air discharge spigot available as an option.
- Toshiba's most powerful ducted unit delivering air flows up to 2340m<sup>3</sup>/h.
- Diffuser design flexibility to select the right layout for the room shape / end user requirements.



Hi - Res Image 



### Performance Data

Capacity Code		HP	5.0
Nominal	Cooling Capacity	kW	14.0
	Heating Capacity	kW	16.0
UK	Cooling Total/Sensible	kW	12.7/9.3
	Heating	kW	10.9
	Power Input	kW	0.300
Electrical	Run Current	Amps	1.81
	Start Current	Amps	2.41

### Indoor Data

Airflow	High - Medium - Low	l/s	650 - 550 - 471
	High - Medium - Low	m <sup>3</sup> /h	2340 - 1980 - 1695
External Static Pressure	Standard	Pa	100
	Maximum	Pa	200
Sound	Pressure High - Medium - Low	dB(A)	44 - 41 - 38
	Power High - Medium - Low	dB(A)	59 - 56 - 53
Unit	Height x Width x Depth	mm	298 x 1400 x 750
	Weight	kg	43
Pipe Connection	Flare Connections (gas - liquid)	inch	5/8 - 3/8
	Drain Pipe Connection OD/ID	mm	32/25
Power Supply	Suggested Fuse Size	V/ph/Hz-A	220-240/1/50-10

### Accessories

<a href="#">RBC-AMTU31-E</a>	Standard Remote Controller - Full control including service functions
<a href="#">RBC-ASCU11-E</a>	Compact Remote Controller - Includes timer off, back light display, multilingual
<a href="#">RBC-AWSU52-E</a>	Premium Controller - Includes timer and back light display, multilingual (inc. Bluetooth)
<a href="#">RBC-MTSC1</a>	Mini Touch Screen Controller - with configurable icons for indoor units
<a href="#">RBC-MTSC2</a>	Mini Touch Screen Controller - with Schedule Timer, configurable icons for indoor units
<a href="#">TCB-SF160C6BE</a>	Spigot shaped flange - For models - (0361/0481/0561) - Spigot diameter 200mm
<a href="#">TCB-LK1401D-E</a>	Long Life Filter Kits - For use with - (0361/0481/0561)
<a href="#">TCB-FF151US-E</a>	Auxiliary Fresh Air Flange - for use with - (all models)

\*All [Accessories / Controls](#)

Compatible R410a outdoor condensers:

**[Mini SMMS-e](#), [SMMS-u](#), [SHRM-e](#)**

Compatible R32 outdoor condensers:

**[Mini SMMS](#), [SHRM-a](#)**

Related items:

- [Full specification](#)
- [BIM files](#)
- [CAD files](#)
- [Airflow/ fan curve](#)
- [Dimensional drawing](#)
- [Wiring diagram](#)
- [Noise curve data](#)
- [Installation manual](#)

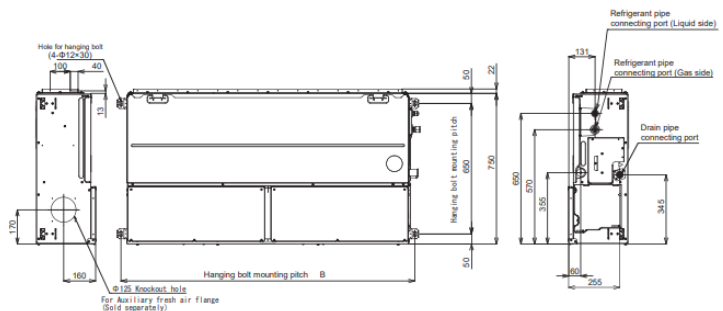

## VRF HIGH STATIC DUCTED: MMD - UP0561HP-E

- Unobtrusive, flexible and compact (298mm depth).
- Static pressure can be set to 6 levels from 50 to 200Pa.
- Long-life filter and air discharge spigot available as an option.
- Toshiba's most powerful ducted unit delivering air flows up to 2760m<sup>3</sup>/h.
- Diffuser design flexibility to select the right layout for the room shape / end user requirements.



Hi - Res Image 



### Performance Data

Capacity Code		HP	6.0
Nominal	Cooling Capacity	kW	16.0
	Heating Capacity	kW	18.0
UK	Cooling Total/Sensible	kW	14.5/10.6
	Heating	kW	12.2
	Power Input	kW	0.400
Electrical	Run Current	Amps	2.48
	Start Current	Amps	3.08

### Indoor Data

Airflow	High - Medium - Low	l/s	767 - 650 - 533
	High - Medium - Low	m <sup>3</sup> /h	2760 - 2340 - 1920
External Static Pressure	Standard	Pa	100
	Maximum	Pa	200
Sound	Pressure High - Medium - Low	dB(A)	46 - 44 - 41
	Power High - Medium - Low	dB(A)	61 - 59 - 56
Unit	Height x Width x Depth	mm	298 x 1400 x 750
	Weight	kg	43
Pipe Connection	Flare Connections (gas - liquid)	inch	5/8 - 3/8
	Drain Pipe Connection OD/ID	mm	32/25
Power Supply	Suggested Fuse Size	V/ph/Hz-A	220-240/1/50-10

### Accessories

<a href="#">RBC-AMTU31-E</a>	Standard Remote Controller - Full control including service functions
<a href="#">RBC-ASCU11-E</a>	Compact Remote Controller - Includes timer off, back light display, multilingual
<a href="#">RBC-AWSU52-E</a>	Premium Controller - Includes timer and back light display, multilingual (inc. Bluetooth)
<a href="#">RBC-MTSC1</a>	Mini Touch Screen Controller - with configurable icons for indoor units
<a href="#">RBC-MTSC2</a>	Mini Touch Screen Controller - with Schedule Timer, configurable icons for indoor units
<a href="#">TCB-SF160C6BE</a>	Spigot shaped flange - For models - (0361/0481/0561) - Spigot diameter 200mm
<a href="#">TCB-LK1401D-E</a>	Long Life Filter Kits - For use with - (0361/0481/0561)
<a href="#">TCB-FF151US-E</a>	Auxiliary Fresh Air Flange - for use with - (all models)

\*All [Accessories](#) / [Controls](#)

Compatible R410a outdoor condensers:

**[Mini SMMS-e](#), [SMMS-u](#), [SHRM-e](#)**

Compatible R32 outdoor condensers:

**[Mini SMMS](#), [SHRM-a](#)**

Related items:

- [Full specification](#)
- [BIM files](#)
- [CAD files](#)
- [Airflow/ fan curve](#)
- [Dimensional drawing](#)
- [Wiring diagram](#)
- [Noise curve data](#)
- [Installation manual](#)

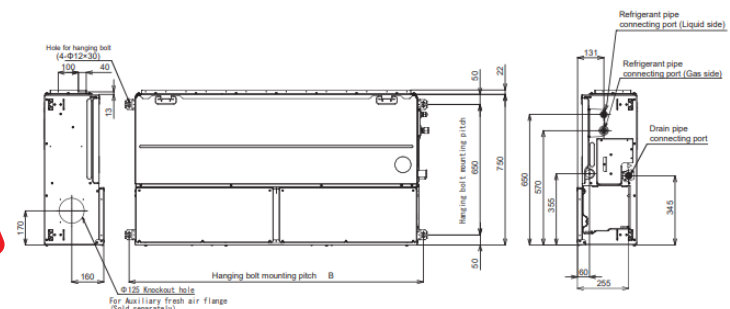

## VRF HIGH STATIC DUCTED: MMD - UP0721HP-E1

- Long-life filter available as an option.
- Unobtrusive, flexible and compact (448mm depth).
- Static pressure can be set to 7 levels from 50 to 200Pa.
- Toshiba's most powerful ducted unit delivering air flows up to 3800m<sup>3</sup>/h.
- Diffuser design flexibility to select the right layout for the room shape / end user requirements.



Hi - Res Image 



### Performance Data

Capacity Code		HP	8.0
Nominal	Cooling Capacity	kW	22.4
	Heating Capacity	kW	25.0
UK	Cooling Total/Sensible	kW	20.3/14.1
	Heating	kW	17.0
Electrical	Power Input	kW	0.540
	Run Current	Amps	2.83
	Start Current	Amps	7.80

### Indoor Data

Airflow	High - Medium - Low	l/s	1056 - 889 - 694
	High - Medium - Low	m <sup>3</sup> /h	3800 - 3200 - 2500
External Static Pressure	Standard	Pa	150
	Maximum	Pa	250
Sound	Pressure High - Medium - Low	dB(A)	44 - 40 - 36
	Power High - Medium - Low	dB(A)	59 - 55 - 51
Unit	Height x Width x Depth	mm	448 x 1400 x 900
	Weight	kg	97
Pipe Connection	Flare Connections (gas - liquid)	inch	7/8 - 1/2
	Drain Pipe Connection OD/ID	mm	32/25
Power Supply	Suggested Fuse Size	V/ph/Hz-A	220-240/1/50-16

### Accessories

<a href="#">RBC-AMTU31-E</a>	Standard Remote Controller - Full control including service functions
<a href="#">RBC-ASCU11-E</a>	Compact Remote Controller - Includes timer off, back light display, multilingual
<a href="#">RBC-AWSU52-E</a>	Premium Controller - Includes timer and back light display, multilingual (inc. Bluetooth)
<a href="#">RBC-MTSC1</a>	Mini Touch Screen Controller - with configurable icons for indoor units
<a href="#">RBC-MTSC2</a>	Mini Touch Screen Controller - with Schedule Timer, configurable icons for indoor units
<a href="#">TCB-LK2801DP-E</a>	Long Life Filter Kits - For use with - (0721/0961)
<a href="#">TCB-DP40DP-E</a>	Drain Pump Kit - for use with - (0721/0961)
<a href="#">TCB-FF151US-E</a>	Auxiliary Fresh Air Flange - for use with - (all models)

\*All [Accessories](#) / [Controls](#)

Compatible R410a outdoor condensers:

**[Mini SMMS-e](#), [SMMS-u](#), [SHRM-e](#)**

Compatible R32 outdoor condensers:

**[Mini SMMS](#), [SHRM-a](#)**

Related items:

- [Full specification](#)
- [BIM files](#)
- [CAD files](#)
- [Airflow/ fan curve](#)
- [Dimensional drawing](#)
- [Wiring diagram](#)
- [Noise curve data](#)
- [Installation manual](#)

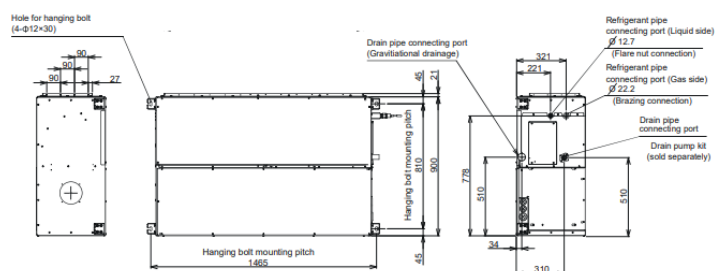

## VRF HIGH STATIC DUCTED: MMD - UP0961HP-E1

- Long-life filter available as an option.
- Unobtrusive, flexible and compact (448mm depth).
- Static pressure can be set to 7 levels from 50 to 200Pa.
- Toshiba's most powerful ducted unit delivering air flows up to 4800m<sup>3</sup>/h.
- Diffuser design flexibility to select the right layout for the room shape / end user requirements.



Hi - Res Image 



### Performance Data

Capacity Code		HP	10.0
Nominal	Cooling Capacity	kW	28.0
	Heating Capacity	kW	31.5
UK	Cooling Total/Sensible	kW	25.4/17.3
	Heating	kW	21.4
Electrical	Power Input	kW	0.790
	Run Current	Amps	3.77
	Start Current	Amps	7.80

### Indoor Data

Airflow	High - Medium - Low	l/s	1333 - 1167 - 972
	High - Medium - Low	m <sup>3</sup> /h	4800 - 4200 - 3500
External Static Pressure	Standard	Pa	150
	Maximum	Pa	250
Sound	Pressure High - Medium - Low	dB(A)	46 - 42 - 38
	Power High - Medium - Low	dB(A)	61 - 57 - 53
Unit	Height x Width x Depth	mm	448 x 1400 x 900
	Weight	kg	97
Pipe Connection	Flare Connections (gas - liquid)	inch	7/8 - 1/2
	Drain Pipe Connection OD/ID	mm	32/25
Power Supply	Suggested Fuse Size	V/ph/Hz-A	220-240/1/50-16

### Accessories

<a href="#">RBC-AMTU31-E</a>	Standard Remote Controller - Full control including service functions
<a href="#">RBC-ASCU11-E</a>	Compact Remote Controller - Includes timer off, back light display, multilingual
<a href="#">RBC-AWSU52-E</a>	Premium Controller - Includes timer and back light display, multilingual (inc. Bluetooth)
<a href="#">RBC-MTSC1</a>	Mini Touch Screen Controller - with configurable icons for indoor units
<a href="#">RBC-MTSC2</a>	Mini Touch Screen Controller - with Schedule Timer, configurable icons for indoor units
<a href="#">TCB-LK2801DP-E</a>	Long Life Filter Kits - For use with - (0721/0961)
<a href="#">TCB-DP40DP-E</a>	Drain Pump Kit - for us with - (0721/0961)
<a href="#">TCB-FF151US-E</a>	Auxiliary Fresh Air Flange - for use with - (all models)

\*All [Accessories](#) / [Controls](#)

Compatible R410a outdoor condensers:

**[Mini SMMS-e](#), [SMMS-u](#), [SHRM-e](#)**

Compatible R32 outdoor condensers:

**[Mini SMMS](#), [SHRM-a](#)**

Related items:

- [Full specification](#)
- [BIM files](#)
- [CAD files](#)
- [Airflow/ fan curve](#)
- [Dimensional drawing](#)
- [Wiring diagram](#)
- [Noise curve data](#)
- [Installation manual](#)

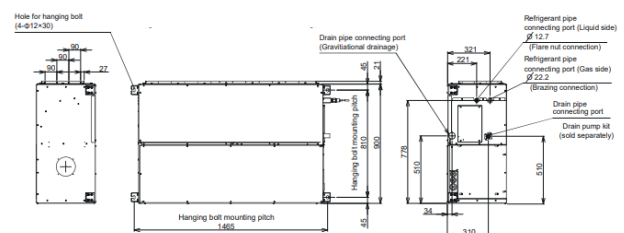



# Ceiling Suspended



## VRF CEILING SUSPENDED: MMC - UP0151HP-E

- High air flow distance up to 8m.
- Low noise levels, thanks to high diameter fan and DC motor.
- Self-cleaning function, enables the air flow to remain constant.
- Suited for a wide range of applications, but particularly refurbishment projects.
- Optimum louvre control: air flow angle is automatically set to cooling or heating needs.



Hi - Res Image 



### Performance Data

Capacity Code		HP	1.7
Nominal	Cooling Capacity	kW	4.5
	Heating Capacity	kW	5.0
UK	Cooling Total/Sensible	kW	4.1/3.0
	Heating	kW	3.4
Electrical	Power Input	kW	0.033
	Run Current	Amps	0.38
	Start Current	Amps	0.54

### Indoor Data

Airflow	High - Medium - Low	l/s	233 - 200 - 150
	High - Medium - Low	m3/h	840 - 690 - 540
Sound	Pressure High - Medium - Low	dB(A)	36 - 34 - 28
	Power High - Medium - Low	dB(A)	51 - 49 - 43
Unit	Height x Width x Depth	mm	235 x 952 x 690
	Weight	kg	24
Pipe Connection	Flare Connections (gas - liquid)	inch	1/2 - 1/4
	Drain Pipe Connection OD/ID	mm	26/20
Power Supply	Suggested Fuse Size	V/ph/Hz-A	220-240/1/50-5

### Accessories

<a href="#">RBC-AMTU31-E</a>	Standard Remote Controller - Full control including service functions
<a href="#">RBC-ASCU11-E</a>	Compact Remote Controller - Includes timer off, back light display, multilingual
<a href="#">RBC-AWSU52-E</a>	Premium Controller - Includes timer and back light display, multilingual (inc. Bluetooth)
<a href="#">RBC-MTSC1</a>	Mini Touch Screen Controller - with configurable icons for indoor units
<a href="#">RBC-MTSC2</a>	Mini Touch Screen Controller - with Schedule Timer, configurable icons for indoor units
<a href="#">RBC-AXU31C-E</a>	Wireless Remote Controller Kit - For use with 0151 to 0561
<a href="#">TCB-DP31CE</a>	Drain pump kit - Antibacterial glass built into drain pump - For use with 0151 to 0561
<a href="#">TCB-KP14CPE</a>	Elbow piping kit - (Required with drain pump kit)

\*All [Accessories](#) / [Controls](#)

Compatible R410a outdoor condensers:

**[Mini SMMS-e](#), [SMMS-u](#), [SHRM-e](#)**

Compatible R32 outdoor condensers:

**[Mini SMMS](#), [SHRM-a](#)**

Related items:

- [Full specification](#)
- [BIM files](#)
- [Airflow/ fan curve](#)
- [Dimensional drawing](#)
- [Wiring diagram](#)
- [Noise curve data](#)
- [Installation manual](#)

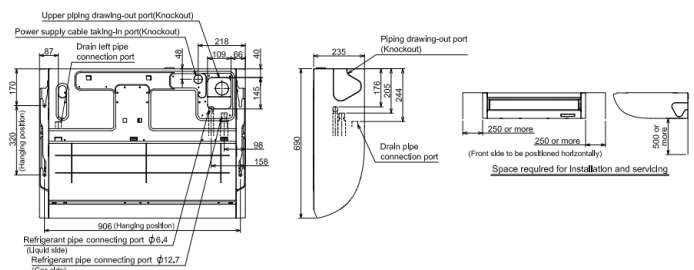

## VRF CEILING SUSPENDED: MMC - UP0181HP-E

- High air flow distance up to 8m.
- Low noise levels, thanks to high diameter fan and DC motor.
- Self-cleaning function, enables the air flow to remain constant.
- Suited for a wide range of applications, but particularly refurbishment projects.
- Optimum louvre control: air flow angle is automatically set to cooling or heating needs.



Hi - Res Image 



### Performance Data

Capacity Code		HP	2.0
Nominal	Cooling Capacity	kW	5.6
	Heating Capacity	kW	6.3
UK	Cooling Total/Sensible	kW	5.1/3.7
	Heating	kW	4.3
Electrical	Power Input	kW	0.034
	Run Current	Amps	0.39
	Start Current	Amps	0.55

### Indoor Data

Airflow	High - Medium - Low	l/s	267 - 200 - 150
	High - Medium - Low	m3/h	960 - 720 - 540
Sound	Pressure High - Medium - Low	dB(A)	37 - 35 - 28
	Power High - Medium - Low	dB(A)	52 - 50 - 43
Unit	Height x Width x Depth	mm	235 x 952 x 690
	Weight	kg	24
Pipe Connection	Flare Connections (gas - liquid)	inch	1/2 - 1/4
	Drain Pipe Connection OD/ID	mm	26/20
Power Supply	Suggested Fuse Size	V/ph/Hz-A	220-240/1/50-5

### Accessories

<a href="#">RBC-AMTU31-E</a>	Standard Remote Controller - Full control including service functions
<a href="#">RBC-ASCU11-E</a>	Compact Remote Controller - Includes timer off, back light display, multilingual
<a href="#">RBC-AWSU52-E</a>	Premium Controller - Includes timer and back light display, multilingual (inc. Bluetooth)
<a href="#">RBC-MTSC1</a>	Mini Touch Screen Controller - with configurable icons for indoor units
<a href="#">RBC-MTSC2</a>	Mini Touch Screen Controller - with Schedule Timer, configurable icons for indoor units
<a href="#">RBC-AXU31C-E</a>	Wireless Remote Controller Kit - For use with 0151 to 0561
<a href="#">TCB-DP31CE</a>	Drain pump kit - Antibacterial glass built into drain pump - For use with 0151 to 0561
<a href="#">TCB-KP14CPE</a>	Elbow piping kit - (Required with drain pump kit)

\*All [Accessories](#) / [Controls](#)

Compatible R410a outdoor condensers:

**[Mini SMMS-e](#), [SMMS-u](#), [SHRM-e](#)**

Compatible R32 outdoor condensers:

**[Mini SMMS](#), [SHRM-a](#)**

Related items:

- [Full specification](#)
- [BIM files](#)
- [Airflow/ fan curve](#)
- [Dimensional drawing](#)
- [Wiring diagram](#)
- [Noise curve data](#)
- [Installation manual](#)

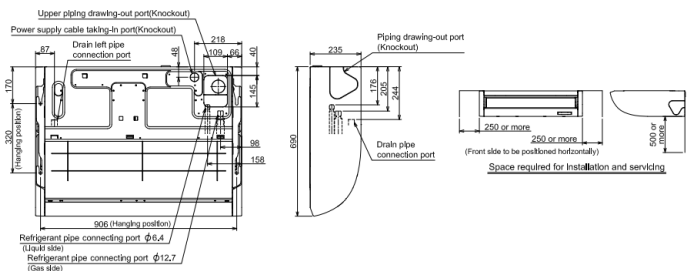

## VRF CEILING SUSPENDED: MMC - UP0241HP-E

- High air flow distance up to 8m.
- Low noise levels, thanks to high diameter fan and DC motor.
- Self-cleaning function, enables the air flow to remain constant.
- Suited for a wide range of applications, but particularly refurbishment projects.
- Optimum louvre control: air flow angle is automatically set to cooling or heating needs.



Hi - Res Image



### Performance Data

Capacity Code		HP	2.5
Nominal	Cooling Capacity	kW	7.1
	Heating Capacity	kW	8
UK	Cooling Total/Sensible	kW	6.4/4.8
	Heating	kW	5.4
Electrical	Power Input	kW	0.067
	Run Current	Amps	0.68
	Start Current	Amps	0.97

### Indoor Data

Airflow	High - Medium - Low	l/s	400 - 283 - 217
	High - Medium - Low	m3/h	1440 - 1020 - 750
Sound	Pressure High - Medium - Low	dB(A)	41 - 36 - 29
	Power High - Medium - Low	dB(A)	56 - 51 - 44
Unit	Height x Width x Depth	mm	235 x 1270 x 690
	Weight	kg	30
Pipe Connection	Flare Connections (gas - liquid)	inch	5/8 - 3/8
	Drain Pipe Connection OD/ID	mm	26/20
Power Supply	Suggested Fuse Size	V/ph/Hz-A	220-240/1/50-5

### Accessories

<a href="#">RBC-AMTU31-E</a>	Standard Remote Controller - Full control including service functions
<a href="#">RBC-ASCU11-E</a>	Compact Remote Controller - Includes timer off, back light display, multilingual
<a href="#">RBC-AWSU52-E</a>	Premium Controller - Includes timer and back light display, multilingual (inc. Bluetooth)
<a href="#">RBC-MTSC1</a>	Mini Touch Screen Controller - with configurable icons for indoor units
<a href="#">RBC-MTSC2</a>	Mini Touch Screen Controller - with Schedule Timer, configurable icons for indoor units
<a href="#">RBC-AXU31C-E</a>	Wireless Remote Controller Kit - For use with 0151 to 0561
<a href="#">TCB-DP31CE</a>	Drain pump kit - Antibacterial glass built into drain pump - For use with 0151 to 0561
<a href="#">TCB-KP24CPE</a>	Elbow piping kit - (Required with drain pump kit)

\*All [Accessories](#) / [Controls](#)

Compatible R410a outdoor condensers:

**[Mini SMMS-e](#), [SMMS-u](#), [SHRM-e](#)**

Compatible R32 outdoor condensers:

**[Mini SMMS](#), [SHRM-a](#)**

Related items:

- [Full specification](#)
- [BIM files](#)
- [Airflow/ fan curve](#)
- [Dimensional drawing](#)
- [Wiring diagram](#)
- [Noise curve data](#)
- [Installation manual](#)

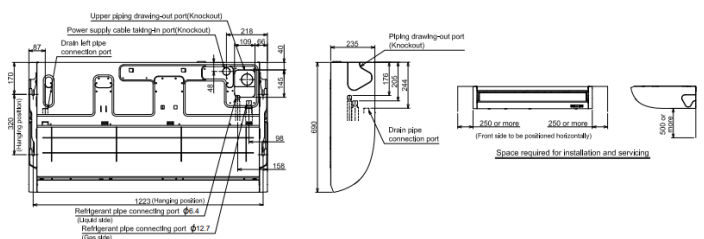

## VRF CEILING SUSPENDED: MMC - UP0271HP-E

- High air flow distance up to 8m.
- Low noise levels, thanks to high diameter fan and DC motor.
- Self-cleaning function, enables the air flow to remain constant.
- Suited for a wide range of applications, but particularly refurbishment projects.
- Optimum louvre control: air flow angle is automatically set to cooling or heating needs.



Hi - Res Image 



### Performance Data

Capacity Code		HP	3.0
Nominal	Cooling Capacity	kW	8
	Heating Capacity	kW	9
UK	Cooling Total/Sensible	kW	7.3/5.3
	Heating	kW	6.1
Electrical	Power Input	kW	0.067
	Run Current	Amps	0.68
	Start Current	Amps	0.97

### Indoor Data

Airflow	High - Medium - Low	l/s	400 - 283 - 217
	High - Medium - Low	m3/h	1440 - 1020 - 750
Sound	Pressure High - Medium - Low	dB(A)	41 - 36 - 29
	Power High - Medium - Low	dB(A)	56 - 51 - 44
Unit	Height x Width x Depth	mm	235 x 1270 x 690
	Weight	kg	30
Pipe Connection	Flare Connections (gas - liquid)	inch	5/8 - 3/8
	Drain Pipe Connection OD/ID	mm	26/20
Power Supply	Suggested Fuse Size	V/ph/Hz-A	220-240/1/50-5

### Accessories

<a href="#">RBC-AMTU31-E</a>	Standard Remote Controller - Full control including service functions
<a href="#">RBC-ASCU11-E</a>	Compact Remote Controller - Includes timer off, back light display, multilingual
<a href="#">RBC-AWSU52-E</a>	Premium Controller - Includes timer and back light display, multilingual (inc. Bluetooth)
<a href="#">RBC-MTSC1</a>	Mini Touch Screen Controller - with configurable icons for indoor units
<a href="#">RBC-MTSC2</a>	Mini Touch Screen Controller - with Schedule Timer, configurable icons for indoor units
<a href="#">RBC-AXU31C-E</a>	Wireless Remote Controller Kit - For use with 0151 to 0561
<a href="#">TCB-DP31CE</a>	Drain pump kit - Antibacterial glass built into drain pump - For use with 0151 to 0561
<a href="#">TCB-KP24CPE</a>	Elbow piping kit - (Required with drain pump kit)

\*All [Accessories](#) / [Controls](#)

Compatible R410a outdoor condensers:

**[Mini SMMS-e](#), [SMMS-u](#), [SHRM-e](#)**

Compatible R32 outdoor condensers:

**[Mini SMMS](#), [SHRM-a](#)**

Related items:

- [Full specification](#)
- [BIM files](#)
- [Airflow/ fan curve](#)
- [Dimensional drawing](#)
- [Wiring diagram](#)
- [Noise curve data](#)
- [Installation manual](#)

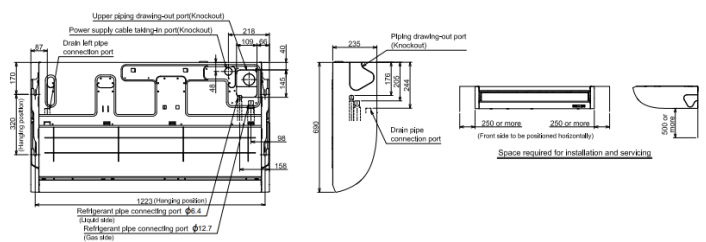

## VRF CEILING SUSPENDED: MMC - UP0361HP-E

- High air flow distance up to 8m.
- Low noise levels, thanks to high diameter fan and DC motor.
- Self-cleaning function, enables the air flow to remain constant.
- Suited for a wide range of applications, but particularly refurbishment projects.
- Optimum louvre control: air flow angle is automatically set to cooling or heating needs.



Hi - Res Image



Performance Data			
Capacity Code		HP	4.0
Nominal	Cooling Capacity	kW	11.2
	Heating Capacity	kW	12.5
UK	Cooling Total/Sensible	kW	10.2/7.2
	Heating	kW	8.5
Electrical	Power Input	kW	0.083
	Run Current	Amps	0.80
	Start Current	Amps	1.16

Indoor Data			
Airflow	High - Medium - Low	l/s	517 - 383 - 283
	High - Medium - Low	m3/h	1860 - 1350 - 1020
Sound	Pressure High - Medium - Low	dB(A)	44 - 38 - 32
	Power High - Medium - Low	dB(A)	59 - 53 - 47
Unit	Height x Width x Depth	mm	235 x 1586 x 690
	Weight	kg	39
Pipe Connection	Flare Connections (gas - liquid)	inch	5/8 - 3/8
	Drain Pipe Connection OD/ID	mm	26/20
Power Supply	Suggested Fuse Size	V/ph/Hz-A	220-240/1/50-5

Accessories	
<a href="#">RBC-AMTU31-E</a>	Standard Remote Controller - Full control including service functions
<a href="#">RBC-ASCU11-E</a>	Compact Remote Controller - Includes timer off, back light display, multilingual
<a href="#">RBC-AWSU52-E</a>	Premium Controller - Includes timer and back light display, multilingual (inc. Bluetooth)
<a href="#">RBC-MTSC1</a>	Mini Touch Screen Controller - with configurable icons for indoor units
<a href="#">RBC-MTSC2</a>	Mini Touch Screen Controller - with Schedule Timer, configurable icons for indoor units
<a href="#">RBC-AXU31C-E</a>	Wireless Remote Controller Kit - For use with 0151 to 0561
<a href="#">TCB-DP31CE</a>	Drain pump kit - Antibacterial glass built into drain pump - For use with 0151 to 0561
<a href="#">TCB-KP24CPE</a>	Elbow piping kit - (Required with drain pump kit)

\*All [Accessories](#) / [Controls](#)

Compatible R410a outdoor condensers:

**[Mini SMMS-e](#), [SMMS-u](#), [SHRM-e](#)**

Compatible R32 outdoor condensers:

**[Mini SMMS](#), [SHRM-a](#)**

Related items:

- [Full specification](#)
- [BIM files](#)
- [Airflow/ fan curve](#)
- [Dimensional drawing](#)
- [Wiring diagram](#)
- [Noise curve data](#)
- [Installation manual](#)

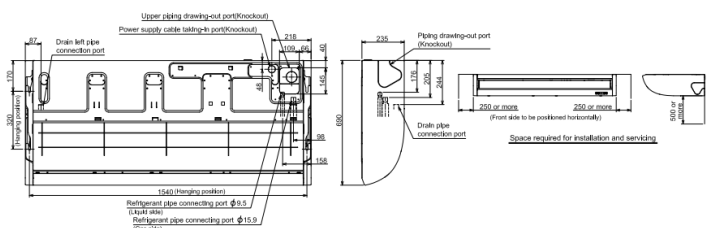

## VRF CEILING SUSPENDED: MMC - UP0481HP-E

- High air flow distance up to 8m.
- Low noise levels, thanks to high diameter fan and DC motor.
- Self-cleaning function, enables the air flow to remain constant.
- Suited for a wide range of applications, but particularly refurbishment projects.
- Optimum louvre control: air flow angle is automatically set to cooling or heating needs.



Hi - Res Image 



Performance Data			
Capacity Code		HP	5.0
Nominal	Cooling Capacity	kW	14
	Heating Capacity	kW	16
UK	Cooling Total/Sensible	kW	12.7/9.3
	Heating	kW	10.9
Electrical	Power Input	kW	0.083
	Run Current	Amps	0.80
	Start Current	Amps	1.16

Indoor Data			
Airflow	High - Medium - Low	l/s	517 - 433 - 333
	High - Medium - Low	m3/h	1860 - 1530 - 1200
Sound	Pressure High - Medium - Low	dB(A)	44 - 41 - 35
	Power High - Medium - Low	dB(A)	59 - 56 - 50
Unit	Height x Width x Depth	mm	235 x 1586 x 690
	Weight	kg	39
Pipe Connection	Flare Connections (gas - liquid)	inch	5/8 - 3/8
	Drain Pipe Connection OD/ID	mm	26/20
Power Supply	Suggested Fuse Size	V/ph/Hz-A	220-240/1/50-5

### Accessories

<a href="#">RBC-AMTU31-E</a>	Standard Remote Controller - Full control including service functions
<a href="#">RBC-ASCU11-E</a>	Compact Remote Controller - Includes timer off, back light display, multilingual
<a href="#">RBC-AWSU52-E</a>	Premium Controller - Includes timer and back light display, multilingual (inc. Bluetooth)
<a href="#">RBC-MTSC1</a>	Mini Touch Screen Controller - with configurable icons for indoor units
<a href="#">RBC-MTSC2</a>	Mini Touch Screen Controller - with Schedule Timer, configurable icons for indoor units
<a href="#">RBC-AXU31C-E</a>	Wireless Remote Controller Kit - For use with 0151 to 0561
<a href="#">TCB-DP31CE</a>	Drain pump kit - Antibacterial glass built into drain pump - For use with 0151 to 0561
<a href="#">TCB-KP24CPE</a>	Elbow piping kit - (Required with drain pump kit)

\*All [Accessories](#) / [Controls](#)

Compatible R410a outdoor condensers:

**[Mini SMMS-e](#), [SMMS-u](#), [SHRM-e](#)**

Compatible R32 outdoor condensers:

**[Mini SMMS](#), [SHRM-a](#)**

Related items:

- [Full specification](#)
- [BIM files](#)
- [Airflow/ fan curve](#)
- [Dimensional drawing](#)
- [Wiring diagram](#)
- [Noise curve data](#)
- [Installation manual](#)

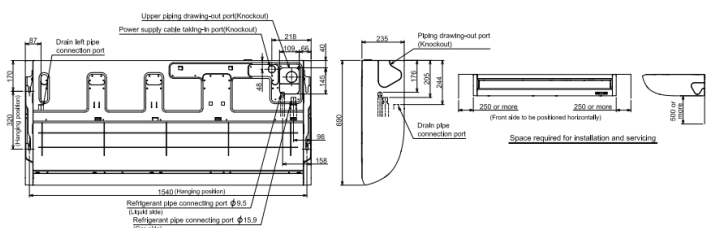

## VRF CEILING SUSPENDED: MMC - UP0561HP-E

- High air flow distance up to 8m.
- Low noise levels, thanks to high diameter fan and DC motor.
- Self-cleaning function, enables the air flow to remain constant.
- Suited for a wide range of applications, but particularly refurbishment projects.
- Optimum louvre control: air flow angle is automatically set to cooling or heating needs.



Hi - Res Image 



### Performance Data

Capacity Code		HP	6.0
Nominal	Cooling Capacity	kW	16
	Heating Capacity	kW	18
UK	Cooling Total/Sensible	kW	14.5/9.4
	Heating	kW	12.2
Electrical	Power Input	kW	0.111
	Run Current	Amps	1.03
	Start Current	Amps	1.49

### Indoor Data

Airflow	High - Medium - Low	l/s	567 - 467 - 350
	High - Medium - Low	m3/h	2040 - 1650 - 1260
Sound	Pressure High - Medium - Low	dB(A)	46 - 42 - 36
	Power High - Medium - Low	dB(A)	61 - 57 - 51
Unit	Height x Width x Depth	mm	235 x 1586 x 690
	Weight	kg	39
Pipe Connection	Flare Connections (gas - liquid)	inch	5/8 - 3/8
	Drain Pipe Connection OD/ID	mm	26/20
Power Supply	Suggested Fuse Size	V/ph/Hz-A	220-240/1/50-5

### Accessories

<a href="#">RBC-AMTU31-E</a>	Standard Remote Controller - Full control including service functions
<a href="#">RBC-ASCU11-E</a>	Compact Remote Controller - Includes timer off, back light display, multilingual
<a href="#">RBC-AWSU52-E</a>	Premium Controller - Includes timer and back light display, multilingual (inc. Bluetooth)
<a href="#">RBC-MTSC1</a>	Mini Touch Screen Controller - with configurable icons for indoor units
<a href="#">RBC-MTSC2</a>	Mini Touch Screen Controller - with Schedule Timer, configurable icons for indoor units
<a href="#">RBC-AXU31C-E</a>	Wireless Remote Controller Kit - For use with 0151 to 0561
<a href="#">TCB-DP31CE</a>	Drain pump kit - Antibacterial glass built into drain pump - For use with 0151 to 0561
<a href="#">TCB-KP24CPE</a>	Elbow piping kit - (Required with drain pump kit)

\*All [Accessories](#) / [Controls](#)

Compatible R410a outdoor condensers:

**[Mini SMMS-e](#), [SMMS-u](#), [SHRM-e](#)**

Compatible R32 outdoor condensers:

**[Mini SMMS](#), [SHRM-a](#)**

Related items:

- [Full specification](#)
- [BIM files](#)
- [Airflow/ fan curve](#)
- [Dimensional drawing](#)
- [Wiring diagram](#)
- [Noise curve data](#)
- [Installation manual](#)

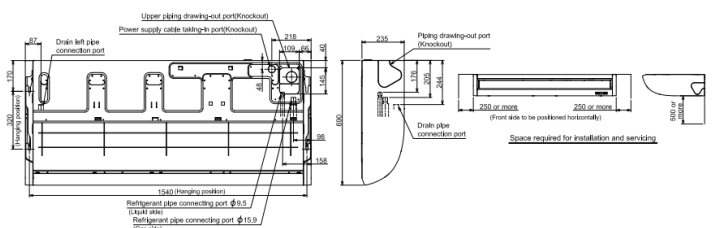



# CONCEALED CHASSIS



## VRF CONCEALED CHASSIS: MML - UP0071BH-E

- Ideal for office and other commercial buildings.
- Fits perfectly for specialist applications such as a library or hospital building.
- Removable split front panel with immediate access to the main components.
- Compact design, which can be installed under a window sill, that is only 600mm in height.
- Depth of only 220mm, the unit can be installed along the wall ensuring maximum space saving.



Hi - Res Image



### Performance Data

Capacity Code		HP	0.8
Nominal	Cooling Capacity	kW	2.2
	Heating Capacity	kW	2.5
UK	Cooling Total/Sensible	kW	2.0/1.3
	Heating	kW	1.7
Electrical	Power Input	kW	0.058
	Run Current	Amps	0.27
	Start Current	Amps	0.60

### Indoor Data

Airflow	High - Medium - Low	l/s	128 - 111 - 83
	High - Medium - Low	m <sup>3</sup> /h	460 - 400 - 300
External Static Pressure	Standard	Pa	5
Sound	Pressure High - Medium - Low	dB(A)	36 - 34 - 32
	Power High - Medium - Low	dB(A)	51 - 49 - 47
Unit	Height x Width x Depth	mm	600 x 745 x 220
	Weight	kg	21
Pipe Connection	Flare Connections (gas - liquid)	inch	3/8 - 1/4
	Drain Pipe Connection ID	mm	20
Power Supply	Suggested Fuse Size	V/ph/Hz-A	220-240/1/50-5

### Accessories

<a href="#">RBC-AMTU31-E</a>	Standard Remote Controller - Full control including service functions
<a href="#">RBC-ASCU11-E</a>	Compact Remote Controller - Includes timer off, back light display, multilingual
<a href="#">RBC-AMSU51-E</a>	Standard Remote Controller - Includes timer off, back light display, multilingual
<a href="#">RBC-AWSU52-E</a>	Premium Controller - Includes timer and back light display, multilingual (inc. Bluetooth)
<a href="#">RBC-MTSC1</a>	Mini Touch Screen Controller - with configurable icons for indoor units
<a href="#">RBC-MTSC2</a>	Mini Touch Screen Controller - with Schedule Timer, configurable icons for indoor units

\*All [Accessories](#) / [Controls](#)

Compatible R410a outdoor condensers:

**[Mini SMMS-e](#), [SMMS-u](#), [SHRM-e](#)**

Compatible R32 outdoor condensers:

**[Mini SMMS](#), [SHRM-a](#)**

Related items:

- [Full specification](#)
- [BIM files](#)
- [Dimensional drawing](#)
- [Wiring diagram](#)
- [Noise curve data](#)
- [Installation manual](#)

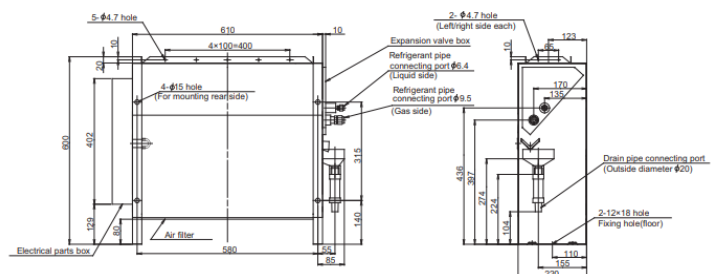

## VRF CONCEALED CHASSIS: MML - UP0091BH-E

- Ideal for office and other commercial buildings.
- Fits perfectly for specialist applications such as a library or hospital building.
- Removable split front panel with immediate access to the main components.
- Compact design, which can be installed under a window sill, that is only 600mm in height.
- Depth of only 220mm, the unit can be installed along the wall ensuring maximum space saving.



Hi - Res Image



### Performance Data

Capacity Code		HP	1.0
Nominal	Cooling Capacity	kW	2.8
	Heating Capacity	kW	3.2
UK	Cooling Total/Sensible	kW	2.5/1.5
	Heating	kW	2.2
Electrical	Power Input	kW	0.058
	Run Current	Amps	0.27
	Start Current	Amps	0.60

### Indoor Data

Airflow	High - Medium - Low	l/s	128 - 111 - 83
	High - Medium - Low	m3/h	460 - 400 - 300
External Static Pressure	Standard	Pa	5
Sound	Pressure High - Medium - Low	dB(A)	36 - 34 - 32
	Power High - Medium - Low	dB(A)	51 - 49 - 47
Unit	Height x Width x Depth	mm	600 x 745 x 220
	Weight	kg	21
Pipe Connection	Flare Connections (gas - liquid)	inch	3/8 - 1/4
	Drain Pipe Connection ID	mm	20
Power Supply	Suggested Fuse Size	V/ph/Hz-A	220-240/1/50-5

### Accessories

<a href="#">RBC-AMTU31-E</a>	Standard Remote Controller - Full control including service functions
<a href="#">RBC-ASCU11-E</a>	Compact Remote Controller - Includes timer off, back light display, multilingual
<a href="#">RBC-AMSU51-E</a>	Standard Remote Controller - Includes timer off, back light display, multilingual
<a href="#">RBC-AWSU52-E</a>	Premium Controller - Includes timer and back light display, multilingual (inc. Bluetooth)
<a href="#">RBC-MTSC1</a>	Mini Touch Screen Controller - with configurable icons for indoor units
<a href="#">RBC-MTSC2</a>	Mini Touch Screen Controller - with Schedule Timer, configurable icons for indoor units

\*All [Accessories](#) / [Controls](#)

Compatible R410a outdoor condensers:

**[Mini SMMS-e](#), [SMMS-u](#), [SHRM-e](#)**

Compatible R32 outdoor condensers:

**[Mini SMMS](#), [SHRM-a](#)**

Related items:

- [Full specification](#)
- [BIM files](#)
- [Dimensional drawing](#)
- [Wiring diagram](#)
- [Noise curve data](#)
- [Installation manual](#)

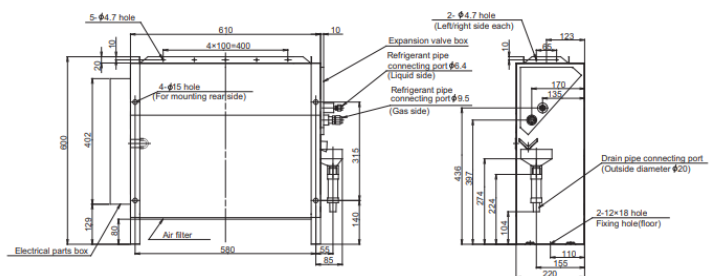

## VRF CONCEALED CHASSIS: MML - UP0121BH-E

- Ideal for office and other commercial buildings.
- Fits perfectly for specialist applications such as a library or hospital building.
- Removable split front panel with immediate access to the main components.
- Compact design, which can be installed under a window sill, that is only 600mm in height.
- Depth of only 220mm, the unit can be installed along the wall ensuring maximum space saving.



Hi - Res Image 



### Performance Data

Capacity Code		HP	1.3
Nominal	Cooling Capacity	kW	3.6
	Heating Capacity	kW	4.0
UK	Cooling Total/Sensible	kW	3.3/2.1
	Heating	kW	2.7
Electrical	Power Input	kW	0.058
	Run Current	Amps	0.27
	Start Current	Amps	0.60

### Indoor Data

Airflow	High - Medium - Low	l/s	128 - 111 - 83
	High - Medium - Low	m <sup>3</sup> /h	460 - 400 - 300
External Static Pressure	Standard	Pa	5
Sound	Pressure High - Medium - Low	dB(A)	36 - 34 - 32
	Power High - Medium - Low	dB(A)	51 - 49 - 47
Unit	Height x Width x Depth	mm	600 x 745 x 220
	Weight	kg	21
Pipe Connection	Flare Connections (gas - liquid)	inch	3/8 - 1/4
	Drain Pipe Connection ID	mm	20
Power Supply	Suggested Fuse Size	V/ph/Hz-A	220-240/1/50-5

### Accessories

<a href="#">RBC-AMTU31-E</a>	Standard Remote Controller - Full control including service functions
<a href="#">RBC-ASCU11-E</a>	Compact Remote Controller - Includes timer off, back light display, multilingual
<a href="#">RBC-AMSU51-E</a>	Standard Remote Controller - Includes timer off, back light display, multilingual
<a href="#">RBC-AWSU52-E</a>	Premium Controller - Includes timer and back light display, multilingual (inc. Bluetooth)
<a href="#">RBC-MTSC1</a>	Mini Touch Screen Controller - with configurable icons for indoor units
<a href="#">RBC-MTSC2</a>	Mini Touch Screen Controller - with Schedule Timer, configurable icons for indoor units

\*All [Accessories](#) / [Controls](#)

Compatible R410a outdoor condensers:

**[Mini SMMS-e](#), [SMMS-u](#), [SHRM-e](#)**

Compatible R32 outdoor condensers:

**[Mini SMMS](#), [SHRM-a](#)**

Related items:

- [Full specification](#)
- [BIM files](#)
- [Dimensional drawing](#)
- [Wiring diagram](#)
- [Noise curve data](#)
- [Installation manual](#)

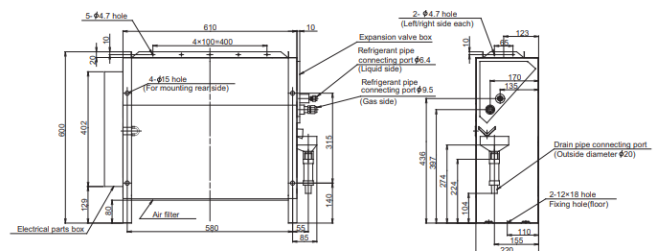

## VRF CONCEALED CHASSIS: MML - UP0151BH-E

- Ideal for office and other commercial buildings.
- Fits perfectly for specialist applications such as a library or hospital building.
- Removable split front panel with immediate access to the main components.
- Compact design, which can be installed under a window sill, that is only 600mm in height.
- Depth of only 220mm, the unit can be installed along the wall ensuring maximum space saving.



Hi - Res Image



### Performance Data

Capacity Code		HP	1.7
Nominal	Cooling Capacity	kW	4.5
	Heating Capacity	kW	5.0
UK	Cooling Total/Sensible	kW	4.1/2.7
	Heating	kW	3.4
	Power Input	kW	0.096
Electrical	Run Current	Amps	0.46
	Start Current	Amps	0.80

### Indoor Data

Airflow	High - Medium - Low	l/s	206 - 167 - 136
	High - Medium - Low	m3/h	740 - 600 - 490
External Static Pressure	Standard	Pa	5
Sound	Pressure High - Medium - Low	dB(A)	36 - 34 - 32
	Power High - Medium - Low	dB(A)	51 - 49 - 47
Unit	Height x Width x Depth	mm	600 x 1045 x 220
	Weight	kg	28
Pipe Connection	Flare Connections (gas - liquid)	inch	1/2 - 1/4
	Drain Pipe Connection ID	mm	20
Power Supply	Suggested Fuse Size	V/ph/Hz-A	220-240/1/50-5

### Accessories

<a href="#">RBC-AMTU31-E</a>	Standard Remote Controller - Full control including service functions
<a href="#">RBC-ASCU11-E</a>	Compact Remote Controller - Includes timer off, back light display, multilingual
<a href="#">RBC-AMSU51-E</a>	Standard Remote Controller - Includes timer off, back light display, multilingual
<a href="#">RBC-AWSU52-E</a>	Premium Controller - Includes timer and back light display, multilingual (inc. Bluetooth)
<a href="#">RBC-MTSC1</a>	Mini Touch Screen Controller - with configurable icons for indoor units
<a href="#">RBC-MTSC2</a>	Mini Touch Screen Controller - with Schedule Timer, configurable icons for indoor units

\*All [Accessories](#) / [Controls](#)

Compatible R410a outdoor condensers:

**[Mini SMMS-e](#), [SMMS-u](#), [SHRM-e](#)**

Compatible R32 outdoor condensers:

**[Mini SMMS](#), [SHRM-a](#)**

Related items:

- [Full specification](#)
- [BIM files](#)
- [Dimensional drawing](#)
- [Wiring diagram](#)
- [Noise curve data](#)
- [Installation manual](#)

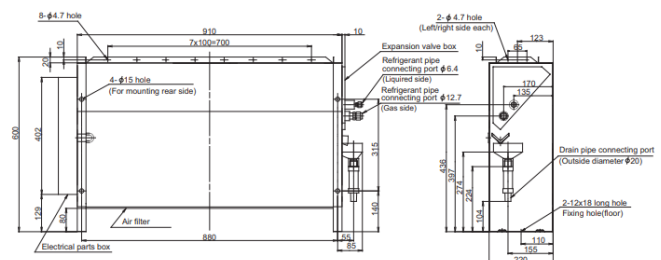

## VRF CONCEALED CHASSIS: MML - UP0181BH-E

- Ideal for office and other commercial buildings.
- Fits perfectly for specialist applications such as a library or hospital building.
- Removable split front panel with immediate access to the main components.
- Compact design, which can be installed under a window sill, that is only 600mm in height.
- Depth of only 220mm, the unit can be installed along the wall ensuring maximum space saving.



Hi - Res Image



### Performance Data

Capacity Code		HP	2.0
Nominal	Cooling Capacity	kW	5.6
	Heating Capacity	kW	6.3
UK	Cooling Total/Sensible	kW	5.1/3.3
	Heating	kW	4.3
Electrical	Power Input	kW	0.096
	Run Current	Amps	0.46
	Start Current	Amps	0.80

### Indoor Data

Airflow	High - Medium - Low	l/s	206 - 167 - 136
	High - Medium - Low	m3/h	740 - 600 - 490
External Static Pressure	Standard	Pa	5
Sound	Pressure High - Medium - Low	dB(A)	36 - 34 - 32
	Power High - Medium - Low	dB(A)	51 - 49 - 47
Unit	Height x Width x Depth	mm	600 x 1045 x 220
	Weight	kg	28
Pipe Connection	Flare Connections (gas - liquid)	inch	1/2 - 1/4
	Drain Pipe Connection ID	mm	20
Power Supply	Suggested Fuse Size	V/ph/Hz-A	220-240/1/50-5

### Accessories

<a href="#">RBC-AMTU31-E</a>	Standard Remote Controller - Full control including service functions
<a href="#">RBC-ASCU11-E</a>	Compact Remote Controller - Includes timer off, back light display, multilingual
<a href="#">RBC-AMSU51-E</a>	Standard Remote Controller - Includes timer off, back light display, multilingual
<a href="#">RBC-AWSU52-E</a>	Premium Controller - Includes timer and back light display, multilingual (inc. Bluetooth)
<a href="#">RBC-MTSC1</a>	Mini Touch Screen Controller - with configurable icons for indoor units
<a href="#">RBC-MTSC2</a>	Mini Touch Screen Controller - with Schedule Timer, configurable icons for indoor units

\*All [Accessories](#) / [Controls](#)

Compatible R410a outdoor condensers:

[Mini SMMS-e](#), [SMMS-u](#), [SHRM-e](#)

Compatible R32 outdoor condensers:

[Mini SMMS](#), [SHRM-a](#)

Related items:

- [Full specification](#)
- [BIM files](#)
- [Dimensional drawing](#)
- [Wiring diagram](#)
- [Noise curve data](#)
- [Installation manual](#)

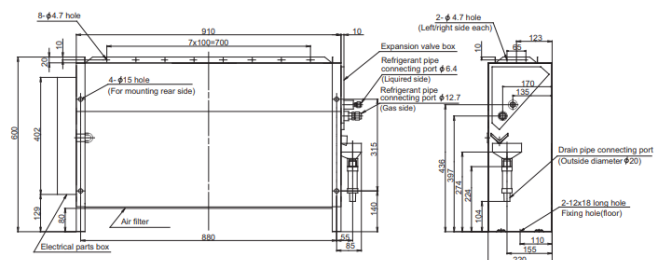

## VRF CONCEALED CHASSIS: MML - UP0241BH-E

- Ideal for office and other commercial buildings.
- Fits perfectly for specialist applications such as a library or hospital building.
- Removable split front panel with immediate access to the main components.
- Compact design, which can be installed under a window sill, that is only 600mm in height.
- Depth of only 220mm, the unit can be installed along the wall ensuring maximum space saving.



Hi - Res Image



### Performance Data

Capacity Code		HP	2.5
Nominal	Cooling Capacity	kW	7.1
	Heating Capacity	kW	8.0
UK	Cooling Total/Sensible	kW	6.4/4.2
	Heating	kW	5.4
Electrical	Power Input	kW	0.110
	Run Current	Amps	0.51
	Start Current	Amps	1.00

### Indoor Data

Airflow	High - Medium - Low	l/s	264 - 219 - 178
	High - Medium - Low	m3/h	950 - 790 - 640
External Static Pressure	Standard	Pa	5
Sound	Pressure High - Medium - Low	dB(A)	42 - 37 - 33
	Power High - Medium - Low	dB(A)	57 - 52 - 48
Unit	Height x Width x Depth	mm	600 x 1045 x 220
	Weight	kg	28
Pipe Connection	Flare Connections (gas - liquid)	inch	5/8 - 3/8
	Drain Pipe Connection ID	mm	20
Power Supply	Suggested Fuse Size	V/ph/Hz-A	220-240/1/50-5

### Accessories

<a href="#">RBC-AMTU31-E</a>	Standard Remote Controller - Full control including service functions
<a href="#">RBC-ASCU11-E</a>	Compact Remote Controller - Includes timer off, back light display, multilingual
<a href="#">RBC-AMSU51-E</a>	Standard Remote Controller - Includes timer off, back light display, multilingual
<a href="#">RBC-AWSU52-E</a>	Premium Controller - Includes timer and back light display, multilingual (inc. Bluetooth)
<a href="#">RBC-MTSC1</a>	Mini Touch Screen Controller - with configurable icons for indoor units
<a href="#">RBC-MTSC2</a>	Mini Touch Screen Controller - with Schedule Timer, configurable icons for indoor units

\*All [Accessories](#) / [Controls](#)

Compatible R410a outdoor condensers:

**[Mini SMMS-e](#), [SMMS-u](#), [SHRM-e](#)**

Compatible R32 outdoor condensers:

**[Mini SMMS](#), [SHRM-a](#)**

Related items:

- [Full specification](#)
- [BIM files](#)
- [Dimensional drawing](#)
- [Wiring diagram](#)
- [Noise curve data](#)
- [Installation manual](#)

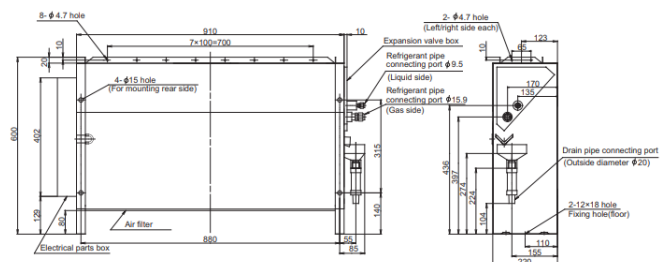

# FLOOR MOUNTED CONSOLE





## VRF FLOOR MOUNTED CONSOLE: MML - UP0071H-E

- One single cabinet size, for all capacity models.
- Minimum space required for installation and servicing.
- Refrigerant and drain piping with four installation possibilities.
- Has the ability to have Air flow in horizontal and vertical direction.
- Perfect choice, for refurbishment projects, where the available space is limited.



Hi - Res Image

### Performance Data

Capacity Code		HP	0.8
Nominal	Cooling Capacity	kW	2.2
	Heating Capacity	kW	2.5
UK	Cooling Total/Sensible	kW	2.0/1.3
	Heating	kW	1.7
Electrical	Power Input	kW	0.056
	Run Current	Amps	0.26
	Start Current	Amps	0.60

### Indoor Data

Airflow	High - Medium - Low	l/s	133 - 117 - 100
	High - Medium - Low	m3/h	480 - 420 - 360
Sound	Pressure High - Medium - Low	dB(A)	39 - 37 - 35
	Power High - Medium - Low	dB(A)	54 - 52 - 50
Unit	Height x Width x Depth	mm	630 x 950 x 230
	Weight	kg	37
Pipe Connection	Flare Connections (gas - liquid)	inch	3/8 - 1/4
	Drain Pipe Connection OD/ID	mm	26/20
Power Supply	Suggested Fuse Size	V/ph/Hz-A	220-240/1/50-5

### Accessories

<a href="#">RBC-AMTU31-E</a>	Standard Remote Controller - Full control including service functions
<a href="#">RBC-ASCU11-E</a>	Compact Remote Controller - Includes timer off, back light display, multilingual
<a href="#">RBC-AMSU51-E</a>	Standard Remote Controller - Includes timer off, back light display, multilingual
<a href="#">RBC-AWSU52-E</a>	Premium Controller - Includes timer and back light display, multilingual (inc. Bluetooth)
<a href="#">RBC-MTSC1</a>	Mini Touch Screen Controller - with configurable icons for indoor units
<a href="#">RBC-MTSC2</a>	Mini Touch Screen Controller - with Schedule Timer, configurable icons for indoor units
<a href="#">RBC-AXU31-E</a>	Wireless Receiver Kit - Compatible with all model sizes

\*All [Accessories](#) / [Controls](#)

Compatible R410a outdoor condensers:

**[Mini SMMS-e](#), [SMMS-u](#), [SHRM-e](#)**

Compatible R32 outdoor condensers:

**[Mini SMMS](#), [SHRM-a](#)**

Related items:

- [Full specification](#)
- [BIM files](#)
- [CAD files](#)
- [Airflow/ fan curve](#)
- [Dimensional drawing](#)
- [Wiring diagram](#)
- [Noise curve data](#)
- [Installation manual](#)

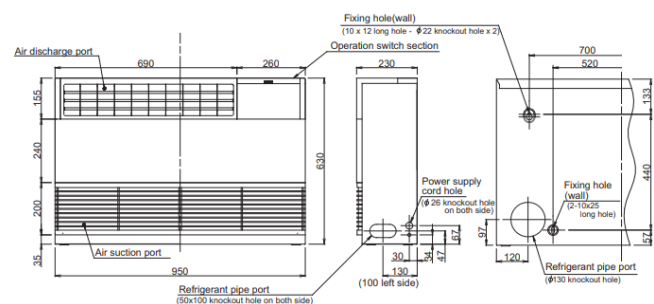

## VRF FLOOR MOUNTED CONSOLE: MML - UP0091H-E

- One single cabinet size, for all capacity models.
- Minimum space required for installation and servicing.
- Refrigerant and drain piping with four installation possibilities.
- Has the ability to have Air flow in horizontal and vertical direction.
- Perfect choice, for refurbishment projects, where the available space is limited.



Hi - Res Image

Performance Data			
Capacity Code		HP	1.0
Nominal	Cooling Capacity	kW	2.8
	Heating Capacity	kW	3.2
UK	Cooling Total/Sensible	kW	2.5/1.5
	Heating	kW	2.2
	Power Input	kW	0.056
Electrical	Run Current	Amps	0.26
	Start Current	Amps	0.60

Indoor Data			
Airflow	High - Medium - Low	l/s	133 - 117 - 100
	High - Medium - Low	m3/h	480 - 420 - 360
Sound	Pressure High - Medium - Low	dB(A)	39 - 37 - 35
	Power High - Medium - Low	dB(A)	54 - 52 - 50
Unit	Height x Width x Depth	mm	630 x 950 x 230
	Weight	kg	37
Pipe Connection	Flare Connections (gas - liquid)	inch	3/8 - 1/4
	Drain Pipe Connection OD/ID	mm	26/20
Power Supply	Suggested Fuse Size	V/ph/Hz-A	220-240/1/50-5

Accessories	
<a href="#">RBC-AMTU31-E</a>	Standard Remote Controller - Full control including service functions
<a href="#">RBC-ASCU11-E</a>	Compact Remote Controller - Includes timer off, back light display, multilingual
<a href="#">RBC-AMSU51-E</a>	Standard Remote Controller - Includes timer off, back light display, multilingual
<a href="#">RBC-AWSU52-E</a>	Premium Controller - Includes timer and back light display, multilingual (inc. Bluetooth)
<a href="#">RBC-MTSC1</a>	Mini Touch Screen Controller - with configurable icons for indoor units
<a href="#">RBC-MTSC2</a>	Mini Touch Screen Controller - with Schedule Timer, configurable icons for indoor units
<a href="#">RBC-AXU31-E</a>	Wireless Receiver Kit - Compatible with all model sizes

\*All [Accessories](#) / [Controls](#)

Compatible R410a outdoor condensers:

**[Mini SMMS-e](#), [SMMS-u](#), [SHRM-e](#)**

Compatible R32 outdoor condensers:

**[Mini SMMS](#), [SHRM-a](#)**

Related items:

- [Full specification](#)
- [BIM files](#)
- [CAD files](#)
- [Airflow/ fan curve](#)
- [Dimensional drawing](#)
- [Wiring diagram](#)
- [Noise curve data](#)
- [Installation manual](#)

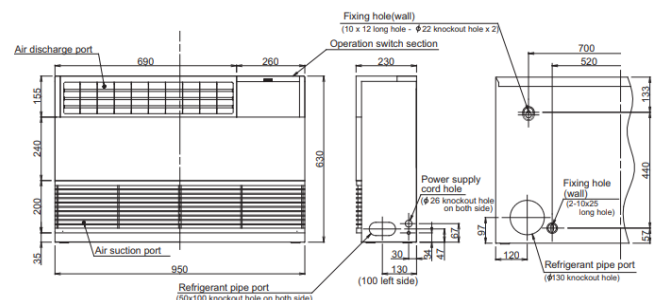

## VRF FLOOR MOUNTED CONSOLE: MML - UP0121H-E

- One single cabinet size, for all capacity models.
- Minimum space required for installation and servicing.
- Refrigerant and drain piping with four installation possibilities.
- Has the ability to have Air flow in horizontal and vertical direction.
- Perfect choice, for refurbishment projects, where the available space is limited.



Hi - Res Image

### Performance Data

Capacity Code		HP	1.3
Nominal	Cooling Capacity	kW	3.6
	Heating Capacity	kW	4.0
UK	Cooling Total/Sensible	kW	3.3/2.1
	Heating	kW	2.7
	Power Input	kW	0.092
Electrical	Run Current	Amps	0.43
	Start Current	Amps	0.80

### Indoor Data

Airflow	High - Medium - Low	l/s	250 - 217 - 180
	High - Medium - Low	m3/h	900 - 780 - 650
Sound	Pressure High - Medium - Low	dB(A)	45 - 41 - 38
	Power High - Medium - Low	dB(A)	60 - 56 - 53
Unit	Height x Width x Depth	mm	630 x 950 x 230
	Weight	kg	37
Pipe Connection	Flare Connections (gas - liquid)	inch	3/8 - 1/4
	Drain Pipe Connection OD/ID	mm	26/20
Power Supply	Suggested Fuse Size	V/ph/Hz-A	220-240/1/50-5

### Accessories

<a href="#">RBC-AMTU31-E</a>	Standard Remote Controller - Full control including service functions
<a href="#">RBC-ASCU11-E</a>	Compact Remote Controller - Includes timer off, back light display, multilingual
<a href="#">RBC-AMSU51-E</a>	Standard Remote Controller - Includes timer off, back light display, multilingual
<a href="#">RBC-AWSU52-E</a>	Premium Controller - Includes timer and back light display, multilingual (inc. Bluetooth)
<a href="#">RBC-MTSC1</a>	Mini Touch Screen Controller - with configurable icons for indoor units
<a href="#">RBC-MTSC2</a>	Mini Touch Screen Controller - with Schedule Timer, configurable icons for indoor units
<a href="#">RBC-AXU31-E</a>	Wireless Receiver Kit - Compatible with all model sizes

\*All [Accessories](#) / [Controls](#)

Compatible R410a outdoor condensers:

**[Mini SMMS-e](#), [SMMS-u](#), [SHRM-e](#)**

Compatible R32 outdoor condensers:

**[Mini SMMS](#), [SHRM-a](#)**

Related items:

- [Full specification](#)
- [BIM files](#)
- [CAD files](#)
- [Airflow/ fan curve](#)
- [Dimensional drawing](#)
- [Wiring diagram](#)
- [Noise curve data](#)
- [Installation manual](#)

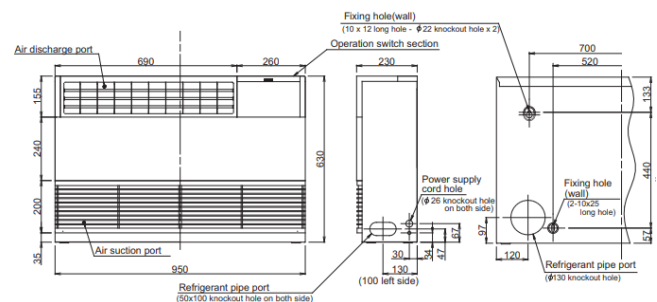

## VRF FLOOR MOUNTED CONSOLE: MML - UP0151H-E

- One single cabinet size, for all capacity models.
- Minimum space required for installation and servicing.
- Refrigerant and drain piping with four installation possibilities.
- Has the ability to have Air flow in horizontal and vertical direction.
- Perfect choice, for refurbishment projects, where the available space is limited.



Hi - Res Image

### Performance Data

Capacity Code		HP	1.7
Nominal	Cooling Capacity	kW	4.5
	Heating Capacity	kW	5.0
UK	Cooling Total/Sensible	kW	3.8/2.5
	Heating	kW	3.4
Electrical	Power Input	kW	0.092
	Run Current	Amps	0.43
	Start Current	Amps	0.80

### Indoor Data

Airflow	High - Medium - Low	l/s	250 - 217 - 180
	High - Medium - Low	m3/h	900 - 780 - 650
Sound	Pressure High - Medium - Low	dB(A)	45 - 41 - 38
	Power High - Medium - Low	dB(A)	60 - 56 - 53
Unit	Height x Width x Depth	mm	630 x 950 x 230
	Weight	kg	37
Pipe Connection	Flare Connections (gas - liquid)	inch	1/2 - 1/4
	Drain Pipe Connection OD/ID	mm	26/20
Power Supply	Suggested Fuse Size	V/ph/Hz-A	220-240/1/50-5

### Accessories

<a href="#">RBC-AMTU31-E</a>	Standard Remote Controller - Full control including service functions
<a href="#">RBC-ASCU11-E</a>	Compact Remote Controller - Includes timer off, back light display, multilingual
<a href="#">RBC-AMSU51-E</a>	Standard Remote Controller - Includes timer off, back light display, multilingual
<a href="#">RBC-AWSU52-E</a>	Premium Controller - Includes timer and back light display, multilingual (inc. Bluetooth)
<a href="#">RBC-MTSC1</a>	Mini Touch Screen Controller - with configurable icons for indoor units
<a href="#">RBC-MTSC2</a>	Mini Touch Screen Controller - with Schedule Timer, configurable icons for indoor units
<a href="#">RBC-AXU31-E</a>	Wireless Receiver Kit - Compatible with all model sizes

\*All [Accessories](#) / [Controls](#)

Compatible R410a outdoor condensers:

**[Mini SMMS-e](#), [SMMS-u](#), [SHRM-e](#)**

Compatible R32 outdoor condensers:

**[Mini SMMS](#), [SHRM-a](#)**

Related items:

- [Full specification](#)
- [BIM files](#)
- [CAD files](#)
- [Airflow/ fan curve](#)
- [Dimensional drawing](#)
- [Wiring diagram](#)
- [Noise curve data](#)
- [Installation manual](#)

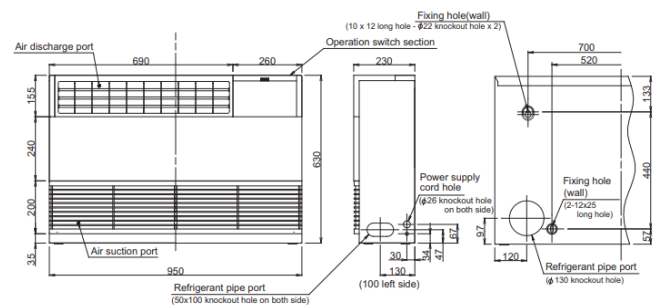

## VRF FLOOR MOUNTED CONSOLE: MML - UP0181H-E

- One single cabinet size, for all capacity models.
- Minimum space required for installation and servicing.
- Refrigerant and drain piping with four installation possibilities.
- Has the ability to have Air flow in horizontal and vertical direction.
- Perfect choice, for refurbishment projects, where the available space is limited.



Hi - Res Image

### Performance Data

Capacity Code		HP	2.0
Nominal	Cooling Capacity	kW	5.6
	Heating Capacity	kW	6.3
UK	Cooling Total/Sensible	kW	5.1/3.3
	Heating	kW	4.3
	Power Input	kW	0.102
Electrical	Run Current	Amps	0.47
	Start Current	Amps	1.10

### Indoor Data

Airflow	High - Medium - Low	l/s	300 - 267 - 217
	High - Medium - Low	m3/h	1080 - 930 - 780
Sound	Pressure High - Medium - Low	dB(A)	49 - 44 - 39
	Power High - Medium - Low	dB(A)	64 - 59 - 54
Unit	Height x Width x Depth	mm	630 x 950 x 230
	Weight	kg	40
Pipe Connection	Flare Connections (gas - liquid)	inch	1/2 - 1/4
	Drain Pipe Connection OD/ID	mm	26/20
Power Supply	Suggested Fuse Size	V/ph/Hz-A	220-240/1/50-5

### Accessories

<a href="#">RBC-AMTU31-E</a>	Standard Remote Controller - Full control including service functions
<a href="#">RBC-ASCU11-E</a>	Compact Remote Controller - Includes timer off, back light display, multilingual
<a href="#">RBC-AMSU51-E</a>	Standard Remote Controller - Includes timer off, back light display, multilingual
<a href="#">RBC-AWSU52-E</a>	Premium Controller - Includes timer and back light display, multilingual (inc. Bluetooth)
<a href="#">RBC-MTSC1</a>	Mini Touch Screen Controller - with configurable icons for indoor units
<a href="#">RBC-MTSC2</a>	Mini Touch Screen Controller - with Schedule Timer, configurable icons for indoor units
<a href="#">RBC-AXU31-E</a>	Wireless Receiver Kit - Compatible with all model sizes

\*All [Accessories](#) / [Controls](#)

Compatible R410a outdoor condensers:

**[Mini SMMS-e](#), [SMMS-u](#), [SHRM-e](#)**

Compatible R32 outdoor condensers:

**[Mini SMMS](#), [SHRM-a](#)**

Related items:

- [Full specification](#)
- [BIM files](#)
- [CAD files](#)
- [Airflow/ fan curve](#)
- [Dimensional drawing](#)
- [Wiring diagram](#)
- [Noise curve data](#)
- [Installation manual](#)

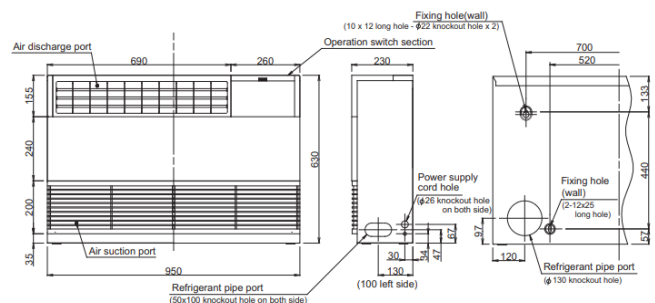

## VRF FLOOR MOUNTED CONSOLE: MML - UP0241H-E

- One single cabinet size, for all capacity models.
- Minimum space required for installation and servicing.
- Refrigerant and drain piping with four installation possibilities.
- Has the ability to have Air flow in horizontal and vertical direction.
- Perfect choice, for refurbishment projects, where the available space is limited.



Hi - Res Image

### Performance Data

Capacity Code		HP	2.5
Nominal	Cooling Capacity	kW	7.1
	Heating Capacity	kW	8.0
UK	Cooling Total/Sensible	kW	6.4/4.2
	Heating	kW	5.4
Electrical	Power Input	kW	0.102
	Run Current	Amps	0.47
	Start Current	Amps	1.10

### Indoor Data

Airflow	High - Medium - Low	l/s	300 - 267 - 217
	High - Medium - Low	m3/h	1080 - 930 - 780
Sound	Pressure High - Medium - Low	dB(A)	49 - 44 - 39
	Power High - Medium - Low	dB(A)	64 - 59 - 54
Unit	Height x Width x Depth	mm	630 x 950 x 230
	Weight	kg	40
Pipe Connection	Flare Connections (gas - liquid)	inch	5/8 - 3/8
	Drain Pipe Connection OD/ID	mm	26/20
Power Supply	Suggested Fuse Size	V/ph/Hz-A	220-240/1/50-5

### Accessories

<a href="#">RBC-AMTU31-E</a>	Standard Remote Controller - Full control including service functions
<a href="#">RBC-ASCU11-E</a>	Compact Remote Controller - Includes timer off, back light display, multilingual
<a href="#">RBC-AMSU51-E</a>	Standard Remote Controller - Includes timer off, back light display, multilingual
<a href="#">RBC-AWSU52-E</a>	Premium Controller - Includes timer and back light display, multilingual (inc. Bluetooth)
<a href="#">RBC-MTSC1</a>	Mini Touch Screen Controller - with configurable icons for indoor units
<a href="#">RBC-MTSC2</a>	Mini Touch Screen Controller - with Schedule Timer, configurable icons for indoor units
<a href="#">RBC-AXU31-E</a>	Wireless Receiver Kit - Compatible with all model sizes

\*All [Accessories](#) / [Controls](#)

Compatible R410a outdoor condensers:

**[Mini SMMS-e](#), [SMMS-u](#), [SHRM-e](#)**

Compatible R32 outdoor condensers:

**[Mini SMMS](#), [SHRM-a](#)**

Related items:

- [Full specification](#)
- [BIM files](#)
- [CAD files](#)
- [Airflow/ fan curve](#)
- [Dimensional drawing](#)
- [Wiring diagram](#)
- [Noise curve data](#)
- [Installation manual](#)

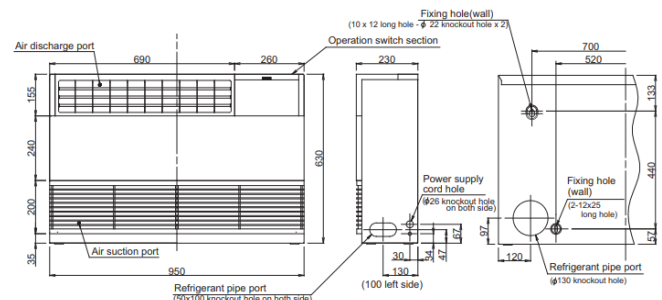

# BI FLOW CONSOLE



## VRF BI FLOW CONSOLE: MML - UP0071NHP-E

- Flexible refrigerant and drain piping.
- Compact space-saving unit design.
- Suitable for refurbishment projects / small spaces.
- Fits perfectly under the window sills or in a low ceiling attic.
- Air distribution can be from front or top to suit individual comfort requirements.



Hi - Res Image 

### Performance Data

Capacity Code		HP	0.8
Nominal	Cooling Capacity	kW	2.2
	Heating Capacity	kW	2.5
UK	Cooling Total/Sensible	kW	2.0/1.6
	Heating	kW	1.7
Electrical	Power Input	kW	0.021
	Run Current	Amps	0.17
	Start Current	Amps	0.26

### Indoor Data

Airflow	High - Medium - Low	l/s	142 - 102 - 78
	High - Medium - Low	m3/h	510 - 366 - 282
Sound	Pressure High - Medium - Low	dB(A)	38 - 32 - 26
	Power High - Medium - Low	dB(A)	53 - 47 - 41
Unit	Height x Width x Depth	mm	600 x 700 x 220
	Weight	kg	17
Pipe Connection	Flare Connections (gas - liquid)	inch	3/8 - 1/4
	Drain Pipe Connection OD/ID	mm	16/14
Power Supply	Suggested Fuse Size	V/ph/Hz-A	220-240/1/50-5
Remote Controller	WH-L11SE (Infra-Red)		

### Accessories

<a href="#">RBC-AMTU31-E</a>	Standard Remote Controller - Full control including service functions
<a href="#">RBC-ASCU11-E</a>	Compact Remote Controller - Includes timer off, back light display, multilingual
<a href="#">RBC-AMSU51-E</a>	Standard Remote Controller - Includes timer off, back light display, multilingual
<a href="#">RBC-AWSU52-E</a>	Premium Controller - Includes timer and back light display, multilingual (inc. Bluetooth)
<a href="#">RBC-MTSC1</a>	Mini Touch Screen Controller - with configurable icons for indoor units
<a href="#">RBC-MTSC2</a>	Mini Touch Screen Controller - with Schedule Timer, configurable icons for indoor units

\*All [Accessories](#) / [Controls](#)

Compatible R410a outdoor condensers:

**[Mini SMMS-e](#), [SMMS-u](#), [SHRM-e](#)**

Compatible R32 outdoor condensers:

**[Mini SMMS](#), [SHRM-a](#)**

Related items:

- [Full specification](#)
- [BIM files](#)
- [Airflow/ fan curve](#)
- [Dimensional drawing](#)
- [Wiring diagram](#)
- [Noise curve data](#)
- [Installation manual](#)

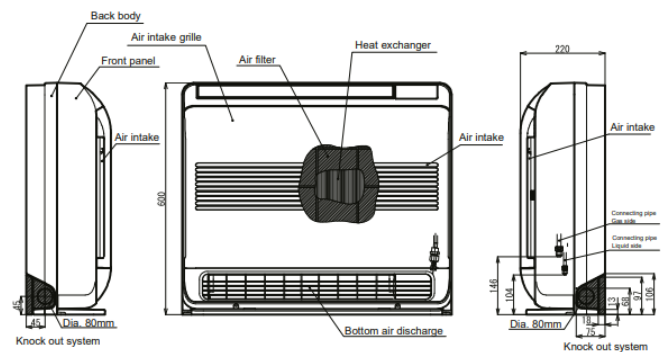



## VRF BI FLOW CONSOLE: MML - UP0091NHP-E

- Flexible refrigerant and drain piping.
- Compact space-saving unit design.
- Suitable for refurbishment projects / small spaces.
- Fits perfectly under the window sills or in a low ceiling attic.
- Air distribution can be from front or top to suit individual comfort requirements.



Hi - Res Image

### Performance Data

Capacity Code		HP	1.0
Nominal	Cooling Capacity	kW	2.8
	Heating Capacity	kW	3.2
UK	Cooling Total/Sensible	kW	2.5/1.9
	Heating	kW	2.2
	Power Input	kW	0.021
Electrical	Run Current	Amps	0.17
	Start Current	Amps	0.26

### Indoor Data

Airflow	High - Medium - Low	l/s	142 - 102 - 78
	High - Medium - Low	m3/h	510 - 366 - 282
Sound	Pressure High - Medium - Low	dB(A)	38 - 32 - 26
	Power High - Medium - Low	dB(A)	53 - 47 - 41
Unit	Height x Width x Depth	mm	600 x 700 x 220
	Weight	kg	17
Pipe Connection	Flare Connections (gas - liquid)	inch	3/8 - 1/4
	Drain Pipe Connection OD/ID	mm	16/14
Power Supply	Suggested Fuse Size	V/ph/Hz-A	220-240/1/50-5
Remote Controller	WH-L11SE (Infra-Red)		

### Accessories

<a href="#">RBC-AMTU31-E</a>	Standard Remote Controller - Full control including service functions
<a href="#">RBC-ASCU11-E</a>	Compact Remote Controller - Includes timer off, back light display, multilingual
<a href="#">RBC-AMSU51-E</a>	Standard Remote Controller - Includes timer off, back light display, multilingual
<a href="#">RBC-AWSU52-E</a>	Premium Controller - Includes timer and back light display, multilingual (inc. Bluetooth)
<a href="#">RBC-MTSC1</a>	Mini Touch Screen Controller - with configurable icons for indoor units
<a href="#">RBC-MTSC2</a>	Mini Touch Screen Controller - with Schedule Timer, configurable icons for indoor units

\*All [Accessories](#) / [Controls](#)

Compatible R410a outdoor condensers:

**[Mini SMMS-e](#), [SMMS-u](#), [SHRM-e](#)**

Compatible R32 outdoor condensers:

**[Mini SMMS](#), [SHRM-a](#)**

Related items:

- [Full specification](#)
- [BIM files](#)
- [Airflow/ fan curve](#)
- [Dimensional drawing](#)
- [Wiring diagram](#)
- [Noise curve data](#)
- [Installation manual](#)

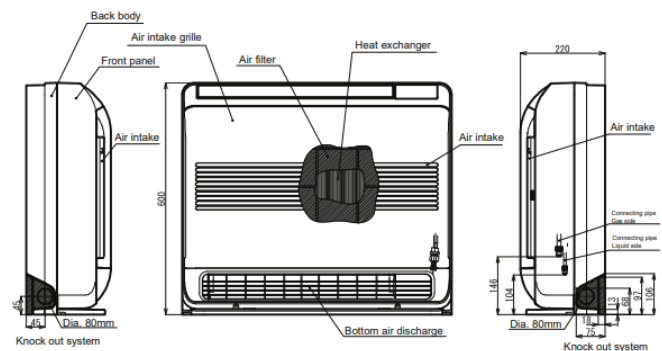

## VRF BI FLOW CONSOLE: MML - UP0121NHP-E

- Flexible refrigerant and drain piping.
- Compact space-saving unit design.
- Suitable for refurbishment projects / small spaces.
- Fits perfectly under the window sills or in a low ceiling attic.
- Air distribution can be from front or top to suit individual comfort requirements.



Hi - Res Image

### Performance Data

Capacity Code		HP	1.3
Nominal	Cooling Capacity	kW	3.6
	Heating Capacity	kW	4.0
UK	Cooling Total/Sensible	kW	3.3/2.4
	Heating	kW	2.7
Electrical	Power Input	kW	0.025
	Run Current	Amps	0.19
	Start Current	Amps	0.30

### Indoor Data

Airflow	High - Medium - Low	l/s	153 - 113 - 90
	High - Medium - Low	m3/h	552 - 408 - 324
Sound	Pressure High - Medium - Low	dB(A)	40 - 34 - 29
	Power High - Medium - Low	dB(A)	55 - 49 - 44
Unit	Height x Width x Depth	mm	600 x 700 x 220
	Weight	kg	17
Pipe Connection	Flare Connections (gas - liquid)	inch	3/8 - 1/4
	Drain Pipe Connection OD/ID	mm	16/14
Power Supply	Suggested Fuse Size	V/ph/Hz-A	220-240/1/50-5
Remote Controller	WH-L11SE (Infra-Red)		

### Accessories

<a href="#">RBC-AMTU31-E</a>	Standard Remote Controller - Full control including service functions
<a href="#">RBC-ASCU11-E</a>	Compact Remote Controller - Includes timer off, back light display, multilingual
<a href="#">RBC-AMSU51-E</a>	Standard Remote Controller - Includes timer off, back light display, multilingual
<a href="#">RBC-AWSU52-E</a>	Premium Controller - Includes timer and back light display, multilingual (inc. Bluetooth)
<a href="#">RBC-MTSC1</a>	Mini Touch Screen Controller - with configurable icons for indoor units
<a href="#">RBC-MTSC2</a>	Mini Touch Screen Controller - with Schedule Timer, configurable icons for indoor units

\*All [Accessories](#) / [Controls](#)

Compatible R410a outdoor condensers:

**[Mini SMMS-e](#), [SMMS-u](#), [SHRM-e](#)**

Compatible R32 outdoor condensers:

**[Mini SMMS](#), [SHRM-a](#)**

Related items:

- [Full specification](#)
- [BIM files](#)
- [Airflow/ fan curve](#)
- [Dimensional drawing](#)
- [Wiring diagram](#)
- [Noise curve data](#)
- [Installation manual](#)

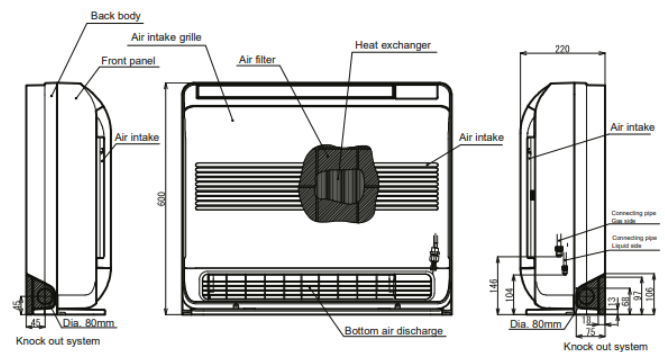

## VRF BI FLOW CONSOLE: MML - UP0151NHP-E

- Flexible refrigerant and drain piping.
- Compact space-saving unit design.
- Suitable for refurbishment projects / small spaces.
- Fits perfectly under the window sills or in a low ceiling attic.
- Air distribution can be from front or top to suit individual comfort requirements.



Hi - Res Image 

### Performance Data

Capacity Code		HP	1.7
Nominal	Cooling Capacity	kW	4.5
	Heating Capacity	kW	5.0
UK	Cooling Total/Sensible	kW	4.1/2.9
	Heating	kW	3.4
Electrical	Power Input	kW	0.034
	Run Current	Amps	0.25
	Start Current	Amps	0.38

### Indoor Data

Airflow	High - Medium - Low	l/s	173 - 130 - 107
	High - Medium - Low	m3/h	624 - 468 - 384
Sound	Pressure High - Medium - Low	dB(A)	43 - 37 - 31
	Power High - Medium - Low	dB(A)	58 - 52 - 46
Unit	Height x Width x Depth	mm	600 x 700 x 220
	Weight	kg	17
Pipe Connection	Flare Connections (gas - liquid)	inch	1/2 - 1/4
	Drain Pipe Connection OD/ID	mm	16/14
Power Supply	Suggested Fuse Size	V/ph/Hz-A	220-240/1/50-5
Remote Controller	WH-L11SE (Infra-Red)		

### Accessories

<a href="#">RBC-AMTU31-E</a>	Standard Remote Controller - Full control including service functions
<a href="#">RBC-ASCU11-E</a>	Compact Remote Controller - Includes timer off, back light display, multilingual
<a href="#">RBC-AMSU51-E</a>	Standard Remote Controller - Includes timer off, back light display, multilingual
<a href="#">RBC-AWSU52-E</a>	Premium Controller - Includes timer and back light display, multilingual (inc. Bluetooth)
<a href="#">RBC-MTSC1</a>	Mini Touch Screen Controller - with configurable icons for indoor units
<a href="#">RBC-MTSC2</a>	Mini Touch Screen Controller - with Schedule Timer, configurable icons for indoor units

\*All [Accessories](#) / [Controls](#)

Compatible R410a outdoor condensers:

**[Mini SMMS-e](#), [SMMS-u](#), [SHRM-e](#)**

Compatible R32 outdoor condensers:

**[Mini SMMS](#), [SHRM-a](#)**

Related items:

- [Full specification](#)
- [BIM files](#)
- [Airflow/ fan curve](#)
- [Dimensional drawing](#)
- [Wiring diagram](#)
- [Noise curve data](#)
- [Installation manual](#)

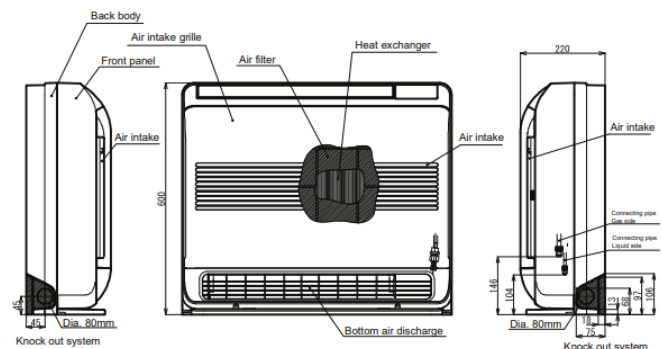

## VRF BI FLOW CONSOLE: MML - UP0181NHP-E

- Flexible refrigerant and drain piping.
- Compact space-saving unit design.
- Suitable for refurbishment projects / small spaces.
- Fits perfectly under the window sills or in a low ceiling attic.
- Air distribution can be from front or top to suit individual comfort requirements.



Hi - Res Image 

### Performance Data

Capacity Code		HP	2.0
Nominal	Cooling Capacity	kW	5.6
	Heating Capacity	kW	6.3
UK	Cooling Total/Sensible	kW	5.1/3.6
	Heating	kW	4.3
Electrical	Power Input	kW	0.052
	Run Current	Amps	0.36
	Start Current	Amps	0.56

### Indoor Data

Airflow	High - Medium - Low	l/s	202 - 147 - 118
	High - Medium - Low	m3/h	726 - 528 - 426
Sound	Pressure High - Medium - Low	dB(A)	47 - 40 - 34
	Power High - Medium - Low	dB(A)	62 - 55 - 49
Unit	Height x Width x Depth	mm	600 x 700 x 220
	Weight	kg	17
Pipe Connection	Flare Connections (gas - liquid)	inch	1/2 - 1/4
	Drain Pipe Connection OD/ID	mm	16/14
Power Supply	Suggested Fuse Size	V/ph/Hz-A	220-240/1/50-5
Remote Controller	WH-L11SE (Infra-Red)		

### Accessories

<a href="#">RBC-AMTU31-E</a>	Standard Remote Controller - Full control including service functions
<a href="#">RBC-ASCU11-E</a>	Compact Remote Controller - Includes timer off, back light display, multilingual
<a href="#">RBC-AMSU51-E</a>	Standard Remote Controller - Includes timer off, back light display, multilingual
<a href="#">RBC-AWSU52-E</a>	Premium Controller - Includes timer and back light display, multilingual (inc. Bluetooth)
<a href="#">RBC-MTSC1</a>	Mini Touch Screen Controller - with configurable icons for indoor units
<a href="#">RBC-MTSC2</a>	Mini Touch Screen Controller - with Schedule Timer, configurable icons for indoor units

\*All [Accessories](#) / [Controls](#)

Compatible R410a outdoor condensers:

**[Mini SMMS-e](#), [SMMS-u](#), [SHRM-e](#)**

Compatible R32 outdoor condensers:

**[Mini SMMS](#), [SHRM-a](#)**

Related items:

- [Full specification](#)
- [BIM files](#)
- [Airflow/ fan curve](#)
- [Dimensional drawing](#)
- [Wiring diagram](#)
- [Noise curve data](#)
- [Installation manual](#)

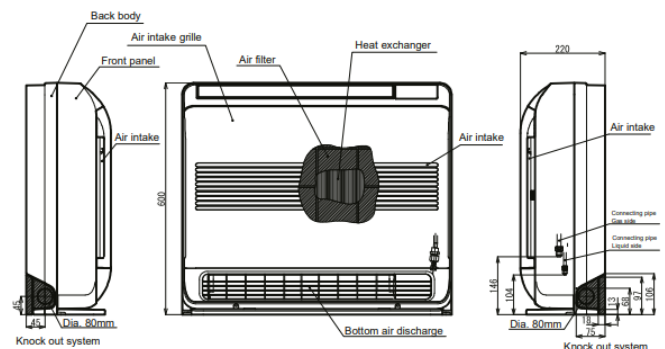

# FLOOR MOUNTED CABINET



## VRF FLOOR MOUNTED CABINET: MMF - UP0151H-E

- Heating capacities from 5 kW to 18 kW.
- Cooling capacities from 4.5 kW to 16 kW.
- High air flows: From 180 l/s to 600 l/s (660 m3/h to 2160 m3/h).
- Suitable to air condition large rooms like shops or showrooms.
- Very small footprint: 0.128 m2 up to 8 kW and 0.243 m2 up to 16 kW.



Hi - Res Image 



### Performance Data

Capacity Code		HP	1.7
Nominal	Cooling Capacity	kW	4.5
	Heating Capacity	kW	5.0
UK	Cooling Total/Sensible	kW	4.1/3.2
	Heating	kW	3.4
Electrical	Power Input	kW	0.053
	Run Current	Amps	0.38
	Start Current	Amps	0.50

### Indoor Data

Airflow	High - Medium - Low	l/s	228 - 194 - 167
	High - Medium - Low	m3/h	820 - 700 - 600
Sound	Pressure High - Medium - Low	dB(A)	46 - 42 - 38
	Power High - Medium - Low	dB(A)	61 - 57 - 53
Unit	Height x Width x Depth	mm	1750 x 600 x 210
	Weight	kg	46
Pipe Connection	Flare Connections (gas - liquid)	inch	1/2 - 1/4
	Drain Pipe Connection ID	mm	20
Power Supply	Suggested Fuse Size	V/ph/Hz-A	220-240/1/50-5

### Accessories

<a href="#">RBC-AMTU31-E</a>	Standard Remote Controller - Full control including service functions
<a href="#">RBC-ASCU11-E</a>	Compact Remote Controller - Includes timer off, back light display, multilingual
<a href="#">RBC-AMSU51-E</a>	Standard Remote Controller - Includes timer off, back light display, multilingual
<a href="#">RBC-AWSU52-E</a>	Premium Controller - Includes timer and back light display, multilingual (inc. Bluetooth)
<a href="#">RBC-MTSC1</a>	Mini Touch Screen Controller - with configurable icons for indoor units
<a href="#">RBC-MTSC2</a>	Mini Touch Screen Controller - with Schedule Timer, configurable icons for indoor units
<a href="#">TCB-PCUC2E</a>	Application control kit - Compatible with all model sizes

\*All [Accessories](#) / [Controls](#)

Compatible R410a outdoor condensers:

**[Mini SMMS-e](#), [SMMS-u](#), [SHRM-e](#)**

Compatible R32 outdoor condensers:

**[Mini SMMS](#), [SHRM-a](#)**

Related items:

- [Full specification](#)
- [BIM files](#)
- [Airflow/ fan curve](#)
- [Dimensional drawing](#)
- [Wiring diagram](#)
- [Noise curve data](#)
- [Installation manual](#)

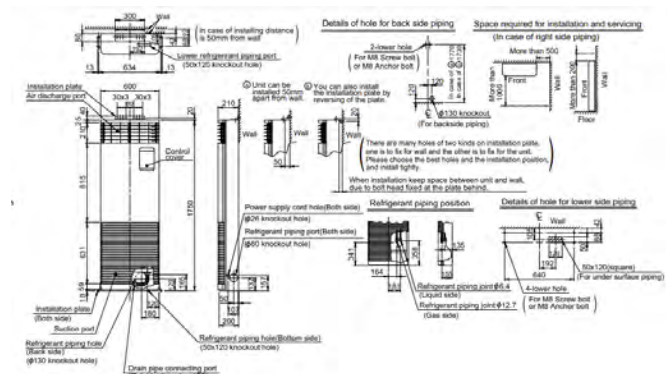

## VRF FLOOR MOUNTED CABINET: MMF - UP0181H-E

- Heating capacities from 5 kW to 18 kW.
- Cooling capacities from 4.5 kW to 16 kW.
- High air flows: From 180 l/s to 600 l/s (660 m3/h to 2160 m3/h).
- Suitable to air condition large rooms like shops or showrooms.
- Very small footprint: 0.128 m2 up to 8 kW and 0.243 m2 up to 16 kW.



Hi - Res Image



### Performance Data

Capacity Code		HP	2.0
Nominal	Cooling Capacity	kW	5.6
	Heating Capacity	kW	6.3
UK	Cooling Total/Sensible	kW	5.1/3.9
	Heating	kW	4.3
Electrical	Power Input	kW	0.053
	Run Current	Amps	0.38
	Start Current	Amps	0.50

### Indoor Data

Airflow	High - Medium - Low	l/s	228 - 194 - 167
	High - Medium - Low	m3/h	820 - 700 - 600
Sound	Pressure High - Medium - Low	dB(A)	46 - 42 - 38
	Power High - Medium - Low	dB(A)	61 - 57 - 53
Unit	Height x Width x Depth	mm	1750 x 600 x 210
	Weight	kg	46
Pipe Connection	Flare Connections (gas - liquid)	inch	1/2 - 1/4
	Drain Pipe Connection OD/ID	mm	20 male screw
Power Supply	Suggested Fuse Size	V/ph/Hz-A	220-240/1/50-5

### Accessories

<a href="#">RBC-AMTU31-E</a>	Standard Remote Controller - Full control including service functions
<a href="#">RBC-ASCU11-E</a>	Compact Remote Controller - Includes timer off, back light display, multilingual
<a href="#">RBC-AMSU51-E</a>	Standard Remote Controller - Includes timer off, back light display, multilingual
<a href="#">RBC-AWSU52-E</a>	Premium Controller - Includes timer and back light display, multilingual (inc. Bluetooth)
<a href="#">RBC-MTSC1</a>	Mini Touch Screen Controller - with configurable icons for indoor units
<a href="#">RBC-MTSC2</a>	Mini Touch Screen Controller - with Schedule Timer, configurable icons for indoor units
<a href="#">TCB-PCUC2E</a>	Application control kit - Compatible with all model sizes

\*All [Accessories](#) / [Controls](#)

Compatible R410a outdoor condensers:

**[Mini SMMS-e](#), [SMMS-u](#), [SHRM-e](#)**

Compatible R32 outdoor condensers:

**[Mini SMMS](#), [SHRM-a](#)**

Related items:

- [Full specification](#)
- [BIM files](#)
- [Airflow/ fan curve](#)
- [Dimensional drawing](#)
- [Wiring diagram](#)
- [Noise curve data](#)
- [Installation manual](#)

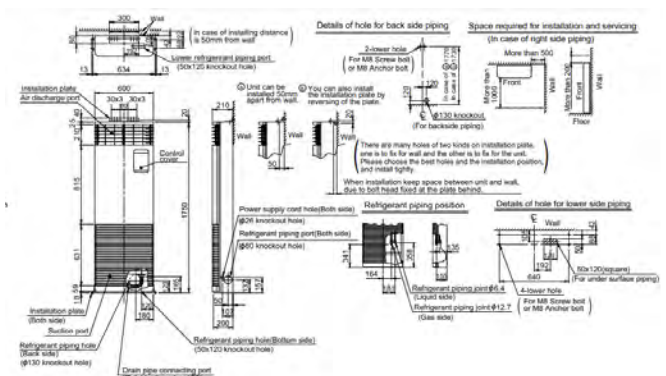

## VRF FLOOR MOUNTED CABINET: MMF - UP0241H-E

- Heating capacities from 5 kW to 18 kW.
- Cooling capacities from 4.5 kW to 16 kW.
- High air flows: From 180 l/s to 600 l/s (660 m3/h to 2160 m3/h).
- Suitable to air condition large rooms like shops or showrooms.
- Very small footprint: 0.128 m2 up to 8 kW and 0.243 m2 up to 16 kW.



Hi - Res Image



### Performance Data

Capacity Code		HP	2.5
Nominal	Cooling Capacity	kW	7.1
	Heating Capacity	kW	8.0
UK	Cooling Total/Sensible	kW	6.4/5.0
	Heating	kW	5.4
Electrical	Power Input	kW	0.087
	Run Current	Amps	0.58
	Start Current	Amps	0.75

### Indoor Data

Airflow	High - Medium - Low	l/s	258 - 214 - 178
	High - Medium - Low	m3/h	930 - 770 - 640
Sound	Pressure High - Medium - Low	dB(A)	50 - 45 - 41
	Power High - Medium - Low	dB(A)	65 - 60 - 56
Unit	Height x Width x Depth	mm	1750 x 600 x 210
	Weight	kg	47
Pipe Connection	Flare Connections (gas - liquid)	inch	5/8 - 3/8
	Drain Pipe Connection ID	mm	20
Power Supply	Suggested Fuse Size	V/ph/Hz-A	220-240/1/50-5

### Accessories

<a href="#">RBC-AMTU31-E</a>	Standard Remote Controller - Full control including service functions
<a href="#">RBC-ASCU11-E</a>	Compact Remote Controller - Includes timer off, back light display, multilingual
<a href="#">RBC-AMSU51-E</a>	Standard Remote Controller - Includes timer off, back light display, multilingual
<a href="#">RBC-AWSU52-E</a>	Premium Controller - Includes timer and back light display, multilingual (inc. Bluetooth)
<a href="#">RBC-MTSC1</a>	Mini Touch Screen Controller - with configurable icons for indoor units
<a href="#">RBC-MTSC2</a>	Mini Touch Screen Controller - with Schedule Timer, configurable icons for indoor units
<a href="#">TCB-PCUC2E</a>	Application control kit - Compatible with all model sizes

\*All [Accessories](#) / [Controls](#)

Compatible R410a outdoor condensers:

**[Mini SMMS-e](#), [SMMS-u](#), [SHRM-e](#)**

Compatible R32 outdoor condensers:

**[Mini SMMS](#), [SHRM-a](#)**

Related items:

- [Full specification](#)
- [BIM files](#)
- [Airflow/ fan curve](#)
- [Dimensional drawing](#)
- [Wiring diagram](#)
- [Noise curve data](#)
- [Installation manual](#)

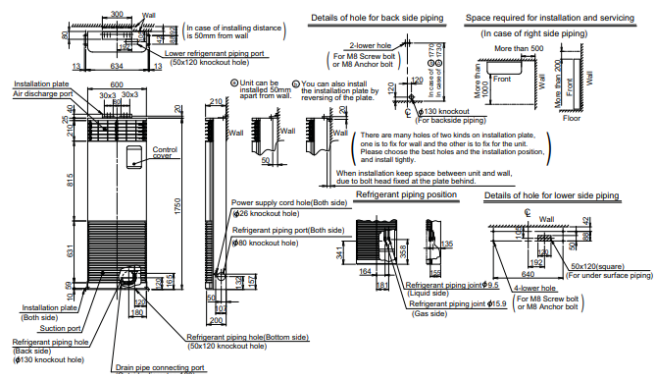



## VRF FLOOR MOUNTED CABINET: MMF - UP0271H-E

- Heating capacities from 5 kW to 18 kW.
- Cooling capacities from 4.5 kW to 16 kW.
- High air flows: From 180 l/s to 600 l/s (660 m3/h to 2160 m3/h).
- Suitable to air condition large rooms like shops or showrooms.
- Very small footprint: 0.128 m2 up to 8 kW and 0.243 m2 up to 16 kW.



Hi - Res Image



### Performance Data

Capacity Code		HP	3.0
Nominal	Cooling Capacity	kW	8.0
	Heating Capacity	kW	9.0
UK	Cooling Total/Sensible	kW	7.3/5.6
	Heating	kW	6.1
Electrical	Power Input	kW	0.087
	Run Current	Amps	0.58
	Start Current	Amps	0.75

### Indoor Data

Airflow	High - Medium - Low	l/s	258 - 214 - 178
	High - Medium - Low	m3/h	930 - 770 - 640
Sound	Pressure High - Medium - Low	dB(A)	50 - 45 - 41
	Power High - Medium - Low	dB(A)	65 - 60 - 56
Unit	Height x Width x Depth	mm	1750 x 600 x 210
	Weight	kg	47
Pipe Connection	Flare Connections (gas - liquid)	inch	5/8 - 3/8
	Drain Pipe Connection OD/ID	mm	20 male screw
Power Supply	Suggested Fuse Size	V/ph/Hz-A	220-240/1/50-5

### Accessories

<a href="#">RBC-AMTU31-E</a>	Standard Remote Controller - Full control including service functions
<a href="#">RBC-ASCU11-E</a>	Compact Remote Controller - Includes timer off, back light display, multilingual
<a href="#">RBC-AMSU51-E</a>	Standard Remote Controller - Includes timer off, back light display, multilingual
<a href="#">RBC-AWSU52-E</a>	Premium Controller - Includes timer and back light display, multilingual (inc. Bluetooth)
<a href="#">RBC-MTSC1</a>	Mini Touch Screen Controller - with configurable icons for indoor units
<a href="#">RBC-MTSC2</a>	Mini Touch Screen Controller - with Schedule Timer, configurable icons for indoor units
<a href="#">TCB-PCUC2E</a>	Application control kit - Compatible with all model sizes

\*All [Accessories](#) / [Controls](#)

Compatible R410a outdoor condensers:

**[Mini SMMS-e](#), [SMMS-u](#), [SHRM-e](#)**

Compatible R32 outdoor condensers:

**[Mini SMMS](#), [SHRM-a](#)**

Related items:

- [Full specification](#)
- [BIM files](#)
- [Airflow/ fan curve](#)
- [Dimensional drawing](#)
- [Wiring diagram](#)
- [Noise curve data](#)
- [Installation manual](#)

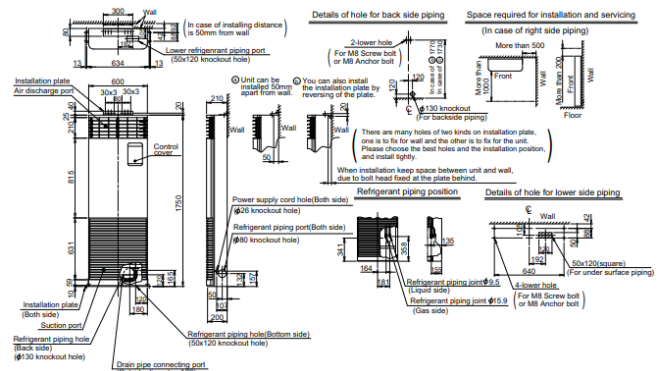

## VRF FLOOR MOUNTED CABINET: MMF - UP0361H-E

- Heating capacities from 5 kW to 18 kW.
- Cooling capacities from 4.5 kW to 16 kW.
- High air flows: From 180 l/s to 600 l/s (660 m3/h to 2160 m3/h).
- Suitable to air condition large rooms like shops or showrooms.
- Very small footprint: 0.128 m2 up to 8 kW and 0.243 m2 up to 16 kW.



Hi - Res Image



### Performance Data

Capacity Code		HP	4.0
Nominal	Cooling Capacity	kW	11.2
	Heating Capacity	kW	12.5
UK	Cooling Total/Sensible	kW	10.2/7.6
	Heating	kW	8.5
Electrical	Power Input	kW	0.133
	Run Current	Amps	0.86
	Start Current	Amps	1.11

### Indoor Data

Airflow	High - Medium - Low	l/s	461 - 394 - 325
	High - Medium - Low	m3/h	1660 - 1420 - 1170
Sound	Pressure High - Medium - Low	dB(A)	51 - 46 - 41
	Power High - Medium - Low	dB(A)	66 - 61 - 56
Unit	Height x Width x Depth	mm	1750 x 600 x 390
	Weight	kg	61
Pipe Connection	Flare Connections (gas - liquid)	inch	5/8 - 3/8
	Drain Pipe Connection ID	mm	20
Power Supply	Suggested Fuse Size	V/ph/Hz-A	220-240/1/50-5

### Accessories

<a href="#">RBC-AMTU31-E</a>	Standard Remote Controller - Full control including service functions
<a href="#">RBC-ASCU11-E</a>	Compact Remote Controller - Includes timer off, back light display, multilingual
<a href="#">RBC-AMSU51-E</a>	Standard Remote Controller - Includes timer off, back light display, multilingual
<a href="#">RBC-AWSU52-E</a>	Premium Controller - Includes timer and back light display, multilingual (inc. Bluetooth)
<a href="#">RBC-MTSC1</a>	Mini Touch Screen Controller - with configurable icons for indoor units
<a href="#">RBC-MTSC2</a>	Mini Touch Screen Controller - with Schedule Timer, configurable icons for indoor units
<a href="#">TCB-PCUC2E</a>	Application control kit - Compatible with all model sizes

\*All [Accessories](#) / [Controls](#)

Compatible R410a outdoor condensers:

**[Mini SMMS-e](#), [SMMS-u](#), [SHRM-e](#)**

Compatible R32 outdoor condensers:

**[Mini SMMS](#), [SHRM-a](#)**

Related items:

- [Full specification](#)
- [BIM files](#)
- [Airflow/ fan curve](#)
- [Dimensional drawing](#)
- [Wiring diagram](#)
- [Noise curve data](#)
- [Installation manual](#)

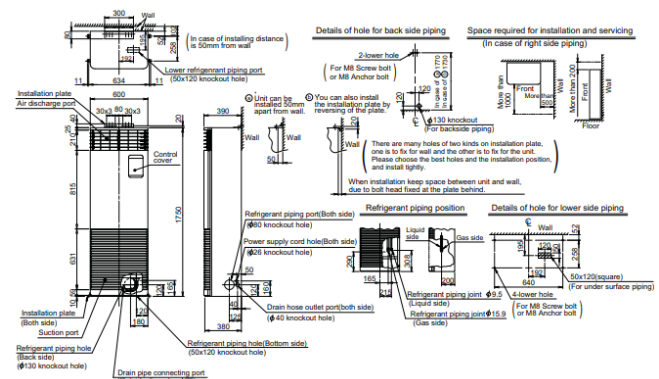

## VRF FLOOR MOUNTED CABINET: MMF - UP0481H-E

- Heating capacities from 5 kW to 18 kW.
- Cooling capacities from 4.5 kW to 16 kW.
- High air flows: From 180 l/s to 600 l/s (660 m3/h to 2160 m3/h).
- Suitable to air condition large rooms like shops or showrooms.
- Very small footprint: 0.128 m2 up to 8 kW and 0.243 m2 up to 16 kW.



Hi - Res Image



### Performance Data

Capacity Code		HP	5.0
Nominal	Cooling Capacity	kW	14.0
	Heating Capacity	kW	16.0
UK	Cooling Total/Sensible	kW	12.7/9.3
	Heating	kW	10.9
Electrical	Power Input	kW	0.158
	Run Current	Amps	1.02
	Start Current	Amps	1.33

### Indoor Data

Airflow	High - Medium - Low	l/s	489 - 411 - 375
	High - Medium - Low	m3/h	1760 - 1480 - 1350
Sound	Pressure High - Medium - Low	dB(A)	53 - 48 - 45
	Power High - Medium - Low	dB(A)	68 - 63 - 60
Unit	Height x Width x Depth	mm	1750 x 600 x 390
	Weight	kg	61
Pipe Connection	Flare Connections (gas - liquid)	inch	5/8 - 3/8
	Drain Pipe Connection ID	mm	20
Power Supply	Suggested Fuse Size	V/ph/Hz-A	220-240/1/50-5

### Accessories

<a href="#">RBC-AMTU31-E</a>	Standard Remote Controller - Full control including service functions
<a href="#">RBC-ASCU11-E</a>	Compact Remote Controller - Includes timer off, back light display, multilingual
<a href="#">RBC-AMSU51-E</a>	Standard Remote Controller - Includes timer off, back light display, multilingual
<a href="#">RBC-AWSU52-E</a>	Premium Controller - Includes timer and back light display, multilingual (inc. Bluetooth)
<a href="#">RBC-MTSC1</a>	Mini Touch Screen Controller - with configurable icons for indoor units
<a href="#">RBC-MTSC2</a>	Mini Touch Screen Controller - with Schedule Timer, configurable icons for indoor units
<a href="#">TCB-PCUC2E</a>	Application control kit - Compatible with all model sizes

\*All [Accessories](#) / [Controls](#)

Compatible R410a outdoor condensers:

**[Mini SMMS-e](#), [SMMS-u](#), [SHRM-e](#)**

Compatible R32 outdoor condensers:

**[Mini SMMS](#), [SHRM-a](#)**

Related items:

- [Full specification](#)
- [BIM files](#)
- [Airflow/ fan curve](#)
- [Dimensional drawing](#)
- [Wiring diagram](#)
- [Noise curve data](#)
- [Installation manual](#)

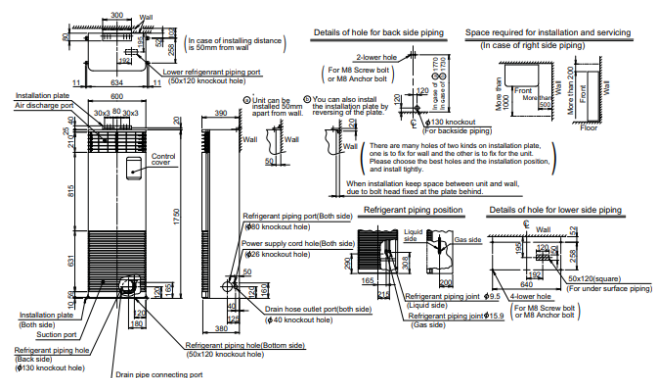

## VRF FLOOR MOUNTED CABINET: MMF - UP0561H-E

- Heating capacities from 5 kW to 18 kW.
- Cooling capacities from 4.5 kW to 16 kW.
- High air flows: From 180 l/s to 600 l/s (660 m3/h to 2160 m3/h).
- Suitable to air condition large rooms like shops or showrooms.
- Very small footprint: 0.128 m2 up to 8 kW and 0.243 m2 up to 16 kW.



Hi - Res Image



### Performance Data

Capacity Code		HP	6.0
Nominal	Cooling Capacity	kW	16.0
	Heating Capacity	kW	18.0
UK	Cooling Total/Sensible	kW	14.5/10.8
	Heating	kW	12.2
Electrical	Power Input	kW	0.158
	Run Current	Amps	1.02
	Start Current	Amps	1.33

### Indoor Data

Airflow	High - Medium - Low	l/s	489 - 411 - 375
	High - Medium - Low	m3/h	1760 - 1480 - 1350
Sound	Pressure High - Medium - Low	dB(A)	53 - 48 - 45
	Power High - Medium - Low	dB(A)	68 - 63 - 60
Unit	Height x Width x Depth	mm	1750 x 600 x 390
	Weight	kg	61
Pipe Connection	Flare Connections (gas - liquid)	inch	5/8 - 3/8
	Drain Pipe Connection ID	mm	20
Power Supply	Suggested Fuse Size	V/ph/Hz-A	220-240/1/50-5

### Accessories

<a href="#">RBC-AMTU31-E</a>	Standard Remote Controller - Full control including service functions
<a href="#">RBC-ASCU11-E</a>	Compact Remote Controller - Includes timer off, back light display, multilingual
<a href="#">RBC-AMSU51-E</a>	Standard Remote Controller - Includes timer off, back light display, multilingual
<a href="#">RBC-AWSU52-E</a>	Premium Controller - Includes timer and back light display, multilingual (inc. Bluetooth)
<a href="#">RBC-MTSC1</a>	Mini Touch Screen Controller - with configurable icons for indoor units
<a href="#">RBC-MTSC2</a>	Mini Touch Screen Controller - with Schedule Timer, configurable icons for indoor units
<a href="#">TCB-PCUC2E</a>	Application control kit - Compatible with all model sizes

\*All [Accessories](#) / [Controls](#)

Compatible R410a outdoor condensers:

[Mini SMMS-e](#), [SMMS-u](#), [SHRM-e](#)

Compatible R32 outdoor condensers:

[Mini SMMS](#), [SHRM-a](#)

Related items:

- [Full specification](#)
- [BIM files](#)
- [Airflow/ fan curve](#)
- [Dimensional drawing](#)
- [Wiring diagram](#)
- [Noise curve data](#)
- [Installation manual](#)

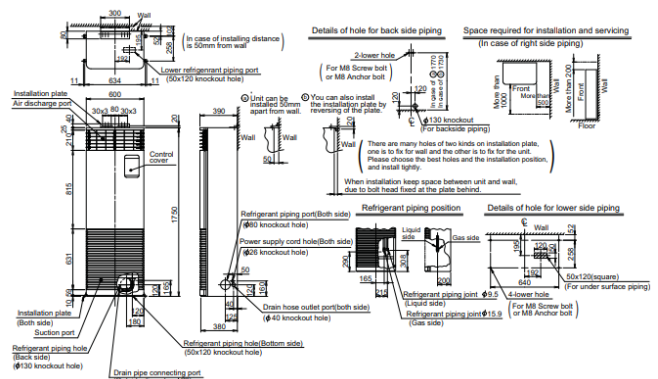

# FRESH AIR INTAKE



## VRF FRESH AIR INTAKE: MMD - UP0481HFP-E

- TU2C-Link control connection.
- External static pressure available up to 200 Pa.
- Ideal solution for all buildings that require fresh air ventilation.
- Standard and high-performance filters available as an option.
- Pre-heat, pre-cool functions (discharge temperature setting range from 13°C to 30°C).



Hi - Res Image

### Performance Data

Capacity Code		HP	5.0
Nominal	Cooling Capacity	kW	14.0
	Heating Capacity	kW	8.9
UK	Cooling Total/Sensible	kW	7.9
	Heating	kW	10.8
Operating Limits	Indoor Temperature Range C/H	°C	13-25/18-30
	Cooling Limit	°C	+22
	Heating Limit	°C	≥ -10/≤ +15
Electrical	Power Input	kW	0.110
	Run Current	Amps	0.77
	Start Current	Amps	2.01

### Indoor Data

Airflow	Standard	l/s	300
	Upper - Lower	l/s	367 - 167
	Standard	m3/h	1080
External Static Pressure	Upper - Lower	m3/h	1320 - 600
	Standard	Pa	100
	Upper - Lower	Pa	200 - 50
Sound	Pressure High - Medium - Low	dB(A)	38 - 35 - 31
	Power High - Medium - Low	dB(A)	52 - 50 - 47
Unit	Height x Width x Depth	mm	327x 1430x 750
	Weight	kg	44
Pipe Connection	Flare Connections (gas - liquid)	inch	5/8 - 3/8
	Drain Pipe Connection OD/ID	mm	32/25
Power Supply	Suggested Fuse Size	V/ph/Hz-A	220-240/1/50-10

### Accessories

<a href="#">RBC-AMTU31-E</a>	Standard Remote Controller - Full control including service functions
<a href="#">RBC-ASCU11-E</a>	Compact Remote Controller - Includes timer off, back light display, multilingual
<a href="#">RBC-AWSU52-E</a>	Premium Controller - Includes timer and back light display, multilingual (inc. Bluetooth)
<a href="#">RBC-MTSC1</a>	Mini Touch Screen Controller - with configurable icons for indoor units
<a href="#">RBC-MTSC2</a>	Mini Touch Screen Controller - with Schedule Timer, configurable icons for indoor units
<a href="#">TCB-UFM0481D-E</a>	High efficiency filter 65 - For use with (0481)
<a href="#">TCB-UFH0481D-E</a>	High efficiency filter 90 - For use with (0481)
<a href="#">TCB-FC0481DF-E</a>	Filter Chamber - For use with (0481)

\*All [Accessories](#) / [Controls](#)

Compatible R410a outdoor condensers:

[Mini SMMS-e](#), [SMMS-u](#), [SHRM-e](#)

Compatible R32 outdoor condensers:

[Mini SMMS](#), [SHRM-a](#)

Related items:

- [Full specification](#)
- [BIM files](#)
- [CAD files](#)
- [Airflow/ fan curve](#)
- [Dimensional drawing](#)
- [Wiring diagram](#)
- [Noise curve data](#)
- [Installation manual](#)

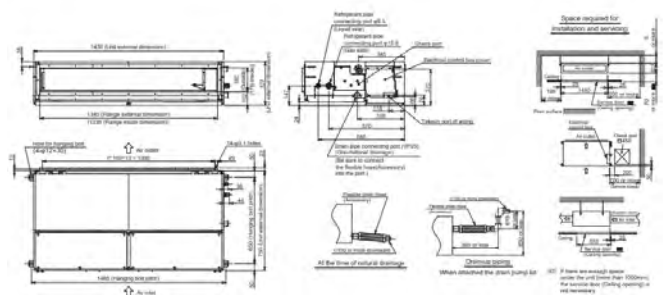

## VRF FRESH AIR INTAKE: MMD - UP0721HFP-E1

- TU2C-Link control connection.
- External static pressure available up to 200 Pa.
- Ideal solution for all buildings that require fresh air ventilation.
- Standard and high-performance filters available as an option.
- Pre-heat, pre-cool functions (discharge temperature setting range from 13°C to 30°C).



Hi - Res Image



### Performance Data

Capacity Code		HP	8.0
Nominal	Cooling Capacity	kW	22.4
	Heating Capacity	kW	13.9
UK	Cooling Total/Sensible	kW	12.3
	Heating	kW	16.8
	Indoor Temperature Range C/H	°C	13-25/18-30
Operating Limits	Cooling Limit	°C	+22
	Heating Limit	°C	≥ -10/≤ +15
	Power Input	kW	0.160
Electrical	Run Current	Amps	0.86
	Start Current	Amps	7.80

### Indoor Data

Airflow	Standard	l/s	467
	Upper - Lower	l/s	567 - 267
	Standard	m3/h	1680
External Static Pressure	Upper - Lower	m3/h	2040 - 960
	Standard	Pa	100
	Upper - Lower	Pa	200 - 50
Sound	Pressure High - Medium - Low	dB(A)	38 - 36 - 33
	Power High - Medium - Low	dB(A)	53 - 51 - 48
	Height x Width x Depth	mm	477x 1430x 900
Unit	Weight	kg	99
	Flare Connections (gas - liquid)	inch	7/8 - 1/2
Pipe Connection	Drain Pipe Connection OD/ID	mm	32/25
	Suggested Fuse Size	V/ph/Hz-A	220-240/1/50-15

### Accessories

<a href="#">RBC-AMTU31-E</a>	Standard Remote Controller - Full control including service functions
<a href="#">RBC-ASCU11-E</a>	Compact Remote Controller - Includes timer off, back light display, multilingual
<a href="#">RBC-AWSU52-E</a>	Premium Controller - Includes timer and back light display, multilingual (inc. Bluetooth)
<a href="#">RBC-MTSC1</a>	Mini Touch Screen Controller - with configurable icons for indoor units
<a href="#">RBC-MTSC2</a>	Mini Touch Screen Controller - with Schedule Timer, configurable icons for indoor units
<a href="#">TCB-UFM1281D-E</a>	High efficiency filter 65 - For use with (0721-1281)
<a href="#">TCB-UFH1281D-E</a>	High efficiency filter 90 - For use with (0721-1281)
<a href="#">TCB-FC1281DF-E</a>	Filter Chamber - For use with (0721-1281)

\*All [Accessories](#) / [Controls](#)

Compatible R410a outdoor condensers:

[Mini SMMS-e](#), [SMMS-u](#), [SHRM-e](#)

Compatible R32 outdoor condensers:

[Mini SMMS](#), [SHRM-a](#)

Related items:

- [Full specification](#)
- [BIM files](#)
- [CAD files](#)
- [Airflow/ fan curve](#)
- [Dimensional drawing](#)
- [Wiring diagram](#)
- [Noise curve data](#)
- [Installation manual](#)

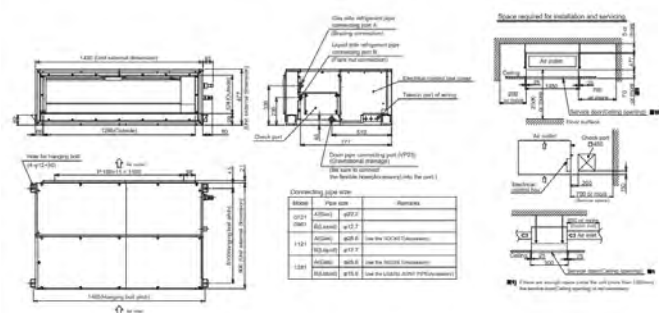

## VRF FRESH AIR INTAKE: MMD - UP0961HFP-E1

- TU2C-Link control connection.
- External static pressure available up to 200 Pa.
- Ideal solution for all buildings that require fresh air ventilation.
- Standard and high-performance filters available as an option.
- Pre-heat, pre-cool functions (discharge temperature setting range from 13°C to 30°C).



Hi - Res Image

### Performance Data

Capacity Code		HP	10.0
Nominal	Cooling Capacity	kW	28.0
	Heating Capacity	kW	17.4
UK	Cooling Total/Sensible	kW	15.3
	Heating	kW	21.0
Operating Limits	Indoor Temperature Range C/H	°C	13-25/18-30
	Cooling Limit	°C	+22
	Heating Limit	°C	≥ -10/≤ +15
Electrical	Power Input	kW	0.200
	Run Current	Amps	1.07
	Start Current	Amps	7.80

### Indoor Data

Airflow	Standard	l/s	583
	Upper - Lower	l/s	700 - 367
	Standard	m3/h	2100
External Static Pressure	Upper - Lower	m3/h	2520 - 1320
	Standard	Pa	100
	Upper - Lower	Pa	200 - 50
Sound	Pressure High - Medium - Low	dB(A)	39 - 36 - 33
	Power High - Medium - Low	dB(A)	54 - 51 - 48
Unit	Height x Width x Depth	mm	477x 1430x 900
	Weight	kg	99
Pipe Connection	Flare Connections (gas - liquid)	inch	7/8 - 1/2
	Drain Pipe Connection OD/ID	mm	32/25
Power Supply	Suggested Fuse Size	V/ph/Hz-A	220-240/1/50-15

### Accessories

<a href="#">RBC-AMTU31-E</a>	Standard Remote Controller - Full control including service functions
<a href="#">RBC-ASCU11-E</a>	Compact Remote Controller - Includes timer off, back light display, multilingual
<a href="#">RBC-AWSU52-E</a>	Premium Controller - Includes timer and back light display, multilingual (inc. Bluetooth)
<a href="#">RBC-MTSC1</a>	Mini Touch Screen Controller - with configurable icons for indoor units
<a href="#">RBC-MTSC2</a>	Mini Touch Screen Controller - with Schedule Timer, configurable icons for indoor units
<a href="#">TCB-UFM1281D-E</a>	High efficiency filter 65 - For use with (0721-1281)
<a href="#">TCB-UFH1281D-E</a>	High efficiency filter 90 - For use with (0721-1281)
<a href="#">TCB-FC1281DF-E</a>	Filter Chamber - For use with (0721-1281)

\*All [Accessories](#) / [Controls](#)

Compatible R410a outdoor condensers:

[Mini SMMS-e](#), [SMMS-u](#), [SHRM-e](#)

Compatible R32 outdoor condensers:

[Mini SMMS](#), [SHRM-a](#)

Related items:

- [Full specification](#)
- [BIM files](#)
- [CAD files](#)
- [Airflow/ fan curve](#)
- [Dimensional drawing](#)
- [Wiring diagram](#)
- [Noise curve data](#)
- [Installation manual](#)

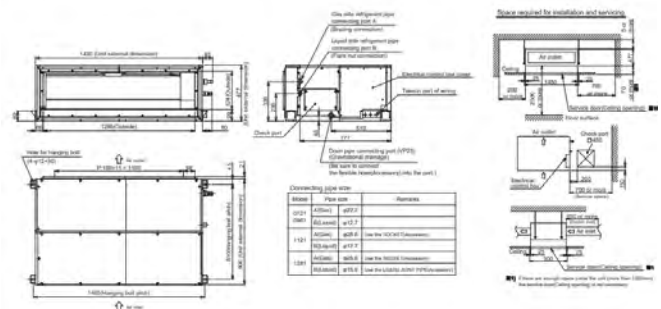



## VRF FRESH AIR INTAKE: MMD - UP1121HFP-E1

- TU2C-Link control connection.
- External static pressure available up to 200 Pa.
- Ideal solution for all buildings that require fresh air ventilation.
- Standard and high-performance filters available as an option.
- Pre-heat, pre-cool functions (discharge temperature setting range from 13°C to 30°C).



Hi - Res Image



### Performance Data

Capacity Code		HP	12.0
Nominal	Cooling Capacity	kW	33.5
	Heating Capacity	kW	20.8
UK	Cooling Total/Sensible	kW	18.4
	Heating	kW	25.2
	Indoor Temperature Range C/H	°C	13-25/18-30
Operating Limits	Cooling Limit	°C	+22
	Heating Limit	°C	≥ -10/≤ +15
	Power Input	kW	0.250
Electrical	Run Current	Amps	1.30
	Start Current	Amps	7.80

### Indoor Data

Airflow	Standard	l/s	700
	Upper - Lower	l/s	850 - 417
	Standard	m3/h	2520
External Static Pressure	Upper - Lower	m3/h	3060 - 1500
	Standard	Pa	100
	Upper - Lower	Pa	200 - 50
Sound	Pressure High - Medium - Low	dB(A)	40 - 37 - 34
	Power High - Medium - Low	dB(A)	55 - 52 - 49
Unit	Height x Width x Depth	mm	477x 1430x 900
	Weight	kg	99
Pipe Connection	Flare Connections (gas - liquid)	inch	1 1/8" - 1/2"
	Drain Pipe Connection OD/ID	mm	32/25
Power Supply	Suggested Fuse Size	V/ph/Hz-A	220-240/1/50-15

### Accessories

<a href="#">RBC-AMTU31-E</a>	Standard Remote Controller - Full control including service functions
<a href="#">RBC-ASCU11-E</a>	Compact Remote Controller - Includes timer off, back light display, multilingual
<a href="#">RBC-AWSU52-E</a>	Premium Controller - Includes timer and back light display, multilingual (inc. Bluetooth)
<a href="#">RBC-MTSC1</a>	Mini Touch Screen Controller - with configurable icons for indoor units
<a href="#">RBC-MTSC2</a>	Mini Touch Screen Controller - with Schedule Timer, configurable icons for indoor units
<a href="#">TCB-UFM1281D-E</a>	High efficiency filter 65 - For use with (0721-1281)
<a href="#">TCB-UFH1281D-E</a>	High efficiency filter 90 - For use with (0721-1281)
<a href="#">TCB-FC1281DF-E</a>	Filter Chamber - For use with (0721-1281)

\*All [Accessories](#) / [Controls](#)

Compatible R410a outdoor condensers:

[Mini SMMS-e](#), [SMMS-u](#), [SHRM-e](#)

Compatible R32 outdoor condensers:

[Mini SMMS](#), [SHRM-a](#)

Related items:

- [Full specification](#)
- [BIM files](#)
- [CAD files](#)
- [Airflow/ fan curve](#)
- [Dimensional drawing](#)
- [Wiring diagram](#)
- [Noise curve data](#)
- [Installation manual](#)

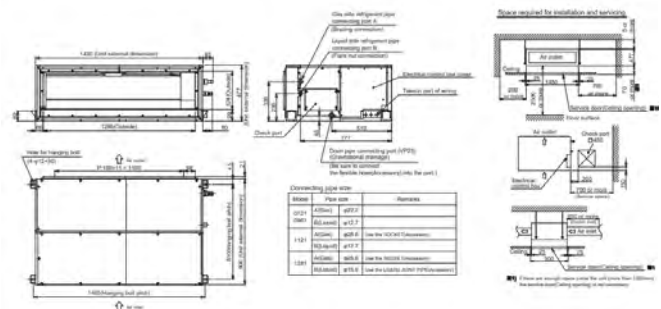

## VRF FRESH AIR INTAKE: MMD - UP1281HFP-E1

- TU2C-Link control connection.
- External static pressure available up to 200 Pa.
- Ideal solution for all buildings that require fresh air ventilation.
- Standard and high-performance filters available as an option.
- Pre-heat, pre-cool functions (discharge temperature setting range from 13°C to 30°C).

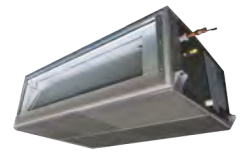

Hi - Res Image

### Performance Data

Capacity Code		HP	14.0
Nominal	Cooling Capacity	kW	40.0
	Heating Capacity	kW	25.2
UK	Cooling Total/Sensible	kW	22.3
	Heating	kW	30.6
Operating Limits	Indoor Temperature Range C/H	°C	13-25/18-30
	Cooling Limit	°C	+22
	Heating Limit	°C	≥ -10/≤ +15
Electrical	Power Input	kW	0.330
	Run Current	Amps	1.83
	Start Current	Amps	7.80

### Indoor Data

Airflow	Standard	l/s	850
	Upper - Lower	l/s	1,000 - 500
	Standard	m3/h	3060
External Static Pressure	Upper - Lower	m3/h	3600 - 1800
	Standard	Pa	100
	Upper - Lower	Pa	200 - 50
Sound	Pressure High - Medium - Low	dB(A)	42 - 38 - 35
	Power High - Medium - Low	dB(A)	57 - 53 - 50
Unit	Height x Width x Depth	mm	477x 1430x 900
	Weight	kg	99
Pipe Connection	Flare Connections (gas - liquid)	inch	1 1/8" - 1/2"
	Drain Pipe Connection OD/ID	mm	32/25
Power Supply	Suggested Fuse Size	V/ph/Hz-A	220-240/1/50-15

### Accessories

<a href="#">RBC-AMTU31-E</a>	Standard Remote Controller - Full control including service functions
<a href="#">RBC-ASCU11-E</a>	Compact Remote Controller - Includes timer off, back light display, multilingual
<a href="#">RBC-AWSU52-E</a>	Premium Controller - Includes timer and back light display, multilingual (inc. Bluetooth)
<a href="#">RBC-MTSC1</a>	Mini Touch Screen Controller - with configurable icons for indoor units
<a href="#">RBC-MTSC2</a>	Mini Touch Screen Controller - with Schedule Timer, configurable icons for indoor units
<a href="#">TCB-UFM1281D-E</a>	High efficiency filter 65 - For use with (0721-1281)
<a href="#">TCB-UFH1281D-E</a>	High efficiency filter 90 - For use with (0721-1281)
<a href="#">TCB-FC1281DF-E</a>	Filter Chamber - For use with (0721-1281)

\*All [Accessories](#) / [Controls](#)

Compatible R410a outdoor condensers:

[Mini SMMS-e](#), [SMMS-u](#), [SHRM-e](#)

Compatible R32 outdoor condensers:

[Mini SMMS](#), [SHRM-a](#)

Related items:

- [Full specification](#)
- [BIM files](#)
- [CAD files](#)
- [Airflow/ fan curve](#)
- [Dimensional drawing](#)
- [Wiring diagram](#)
- [Noise curve data](#)
- [Installation manual](#)

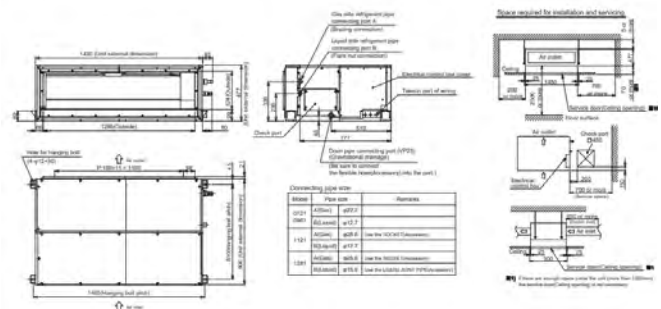

# AIR - TO - AIR HEAT EXCHANGER



## VRF Air-to-Air Heat Exchanger: VN - U00151SY-E

- Expanded operating temperature range.
- Can be linked to the air conditioning system.
- Optional high performance air filter available.
- New DC Fan Motor provides flexible air volume.
- Complies ENTR lot 6 tier 2 requirements for the EU Market.



Hi - Res Image



### Performance Data

Operating Range	Around Unit	°C - %RH	-10 to 50 - ≤ 80
	Outdoor Air	°C - %RH	-20 to 52 - ≤ 80
	Return Air	°C - %RH	5 to 40 - ≤ 80
Airflow	Standard Extra High - High - Low	l/s	41 - 33 - 20
	Standard Extra High - High - Low	m3/h	150 - 120 - 73
Fan	External Static Pressure Extra High - High - Low	Pa	90 - 60 - 26
	Specific Power Extra High - High - Low	W/l/s	1.3 - 1.3 - 1.4
Efficiency	Temperature Exchange Extra High - High - Low	%	77.0 - 80.0 - 81.5
	Enthalpy Exchange Efficiency Cooling Extra High - High - Low	%	83.0 - 83.5 - 85.0
	Enthalpy Exchange Efficiency Heating Extra High - High - Low	%	71.0 - 76.5 - 78.0
Sound	Pressure Extra High - High - Low	dB(A)	28.0 - 25.0 - 20.0
	Power Level Extra High - High - Low	dB(A)	43.0 - 40.0 - 35.0

### Indoor Data

Unit	Heat Exchanger		Special paper + Resin
	Filter Type		Non woven fabric
	Standard Air Filter		Gravitational method*
	High Efficiency Air Filter		Colorimetric method*
	Filtration Efficiency Grade (Collection Effect Weighing Method)	%	82
	Height x Width x Depth	mm	278 x 735 x 778
Electrical	Weight	kg	29
	Duct Nominal Diameter Supply/Return	mm	100 x 2/100 x 2
	Power Input (Heat exchange mode) Extra High - High - Medium - Low	W	56 - 43 - 35 - 28
	Running Current Extra High - High - Medium - Low	Amps	0.61 - 0.47 - 0.40 - 0.32
	Maximum Run Current	Amps	0.61
	Power Supply	V/ph/Hz	220-240/1/50
	Suggested Fused Supply (with Heater Kit)	Amps	3 (10)
	Remote Controller Option		Wired 2-core non-polarity

### Accessories

<a href="#">NRC-01HE</a>	Dedicated air-to-air heat exchanger remote controller.
<a href="#">RBC-AMSU51-E</a>	Standard Remote Controller - Includes timer off, back light display, multilingual
<a href="#">RBC-AWSU52-E</a>	Premium Controller - Includes timer and back light display, multilingual (inc. Bluetooth)
<a href="#">RBC-VNMI1</a>	Duct Heaters - For use with (0151)
<a href="#">TCB-SFMCA1V-E</a>	Multi Function Sensor (CO2/PM) - Compatible with all model sizes
<a href="#">TCB-PSFC551VSY-E</a>	High Performance Filter (Epm1 55%) - (0151,0251)

\*All [Accessories](#) / [Controls](#)

\*Awaiting Factory Confirmation

Compatible R410a outdoor condensers:

[Mini SMMS-e](#), [SMMS-u](#), [SHRM-e](#)

Compatible R32 outdoor condensers:

[Mini SMMS](#), [SHRM-a](#)

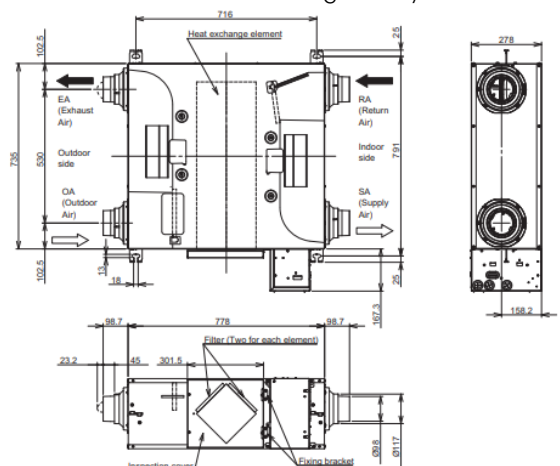

Related items:

- [Full specification](#)
- [BIM files](#)
- [CAD files](#)
- [Airflow/ fan curve](#)
- [Dimensional drawing](#)
- [Wiring diagram](#)
- [Noise curve data](#)
- [Installation manual](#)

## VRF Air-to-Air Heat Exchanger: VN - U00251SY-E

- Expanded operating temperature range.
- Can be linked to the air conditioning system.
- Optional high performance air filter available.
- New DC Fan Motor provides flexible air volume.
- Complies ENTR lot 6 tier 2 requirements for the EU Market.



Hi - Res Image 



### Performance Data

Operating Range	Around Unit	°C - %RH	-10 to 50 - ≤ 80
	Outdoor Air	°C - %RH	-20 to 52 - ≤ 80
	Return Air	°C - %RH	5 to 40 - ≤ 80
Airflow	Standard Extra High - High - Low	l/s	69 - 58 - 27
	Standard Extra High - High - Low	m3/h	250 - 210 - 100
Fan	External Static Pressure Extra High - High - Low	Pa	75 - 53 - 16
	Specific Power Extra High - High - Low	W/l/s	1.1 - 1.0 - 1.0
Efficiency	Temperature Exchange Extra High - High - Low	%	75.0 - 76.0 - 80.5
	Enthalpy Exchange Efficiency Cooling Extra High - High - Low	%	80.0 - 80.5 - 84.0
	Enthalpy Exchange Efficiency Heating Extra High - High - Low	%	70.0 - 71.5 - 77.0
Sound	Pressure Extra High - High - Low	dB(A)	28.0 - 27.0 - 20.0
	Power Level Extra High - High - Low	dB(A)	43.0 - 42.0 - 35.0

### Indoor Data

Unit	Heat Exchanger		Special paper + Resin
	Filter Type		Non woven fabric
	Standard Air Filter		Gravitational method*
	High Efficiency Air Filter		Colorimetric method*
	Filtration Efficiency Grade (Collection Effect Weighing Method)	%	82
Electrical	Height x Width x Depth	mm	278 x 735 x 778
	Weight	kg	29
	Duct Nominal Diameter Supply/Return	mm	150 x 2/150 x 2
	Power Input (Heat exchange mode) Extra High - High - Medium - Low	W	75 - 57 - 39 - 29
	Running Current Extra High - High - Medium - Low	Amps	0.77 - 0.61 - 0.42 - 0.32
	Maximum Run Current	Amps	0.77
	Power Supply	V/ph/Hz	220-240/1/50
	Suggested Fused Supply (with Heater Kit)	Amps	3 (10)
	Remote Controller Option		Wired 2-core non-polarity

### Accessories

<a href="#">NRC-01HE</a>	Dedicated air-to-air heat exchanger remote controller.
<a href="#">RBC-AMSU51-E</a>	Standard Remote Controller - Includes timer off, back light display, multilingual
<a href="#">RBC-AWSU52-E</a>	Premium Controller - Includes timer and back light display, multilingual (inc. Bluetooth)
<a href="#">RBC-VNMF2</a>	Duct Heaters - For use with (0251, 0351)
<a href="#">TCB-SFMCA1V-E</a>	Multi Function Sensor (CO2/PM) - Compatible with all model sizes
<a href="#">TCB-PSFC551VSY-E</a>	High Performance Filter (Epm1 55%) - (0151,0251)

\*All [Accessories](#) / [Controls](#)

Compatible R410a outdoor condensers:

[Mini SMMS-e](#), [SMMS-u](#), [SHRM-e](#)

Compatible R32 outdoor condensers:

[Mini SMMS](#), [SHRM-a](#)

Related items:

- [Full specification](#)
- [BIM files](#)
- [CAD files](#)
- [Airflow/ fan curve](#)
- [Dimensional drawing](#)
- [Wiring diagram](#)
- [Noise curve data](#)
- [Installation manual](#)



\*Awaiting Factory Confirmation

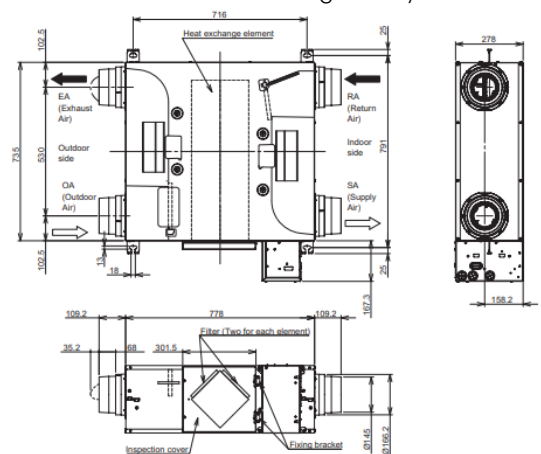

## VRF Air-to-Air Heat Exchanger: VN - U00351SY-E

- Expanded operating temperature range.
- Can be linked to the air conditioning system.
- Optional high performance air filter available.
- New DC Fan Motor provides flexible air volume.
- Complies ENTR lot 6 tier 2 requirements for the EU Market.



### Performance Data

Operating Range	Around Unit	°C - %RH	-10 to 50 - ≤ 80
	Outdoor Air	°C - %RH	-20 to 52 - ≤ 80
	Return Air	°C - %RH	5 to 40 - ≤ 80
Airflow	Standard Extra High - High - Low	l/s	97 - 77 - 38
	Standard Extra High - High - Low	m3/h	350 - 280 - 140
Fan	External Static Pressure Extra High - High - Low	Pa	160 - 100 - 26
	Specific Power Extra High - High - Low	W/l/s	1.6 - 1.2 - 1.0
Efficiency	Temperature Exchange Extra High - High - Low	%	74.0 - 75.0 - 83.5
	Enthalpy Exchange Efficiency Cooling Extra High - High - Low	%	81.0 - 81.5 - 87.0
	Enthalpy Exchange Efficiency Heating Extra High - High - Low	%	67.0 - 68.5 - 80.0
Sound	Pressure Extra High - High - Low	dB(A)	34.0 - 31.0 - 21.0
	Power Level Extra High - High - Low	dB(A)	49.0 - 46.0 - 36.0

### Indoor Data

Unit	Heat Exchanger	Special paper + Resin	
	Filter Type	Non woven fabric	
	Standard Air Filter	Gravitational method*	
	High Efficiency Air Filter	Colorimetric method*	
	Filtration Efficiency Grade (Collection Effect Weighing Method)	%	82
	Height x Width x Depth	mm	305 x 880 x 880
	Weight	kg	40
Electrical	Duct Nominal Diameter Supply/Return	mm	150 x 2/150 x 2
	Power Input (Heat exchange mode) Extra High - High - Medium - Low	W	152 - 92 - 59 - 39
	Running Current Extra High - High - Medium - Low	Amps	1.17 - 0.75 - 0.48 - 0.32
	Maximum Run Current	Amps	1.17
	Power Supply	V/ph/Hz	220-240/1/50
	Suggested Fused Supply (with Heater Kit)	Amps	6 (10)
	Remote Controller Option	Wired 2-core non-polarity	

### Accessories

<a href="#">NRC-01HE</a>	Dedicated air-to-air heat exchanger remote controller.
<a href="#">RBC-AMSU51-E</a>	Standard Remote Controller - Includes timer off, back light display, multilingual
<a href="#">RBC-AWSU52-E</a>	Premium Controller - Includes timer and back light display, multilingual (inc. Bluetooth)
<a href="#">RBC-VNMH2</a>	Duct Heaters - For use with (0251, 0351)
<a href="#">TCB-SFMCA1V-E</a>	Multi Function Sensor (CO2/PM) - Compatible with all model sizes
<a href="#">TCB-PSFC551VMY-E</a>	High Performance Filter (Epm1 55%) - (0351)

\*All [Accessories](#) / [Controls](#)

Compatible R410a outdoor condensers:

[Mini SMMS-e](#), [SMMS-u](#), [SHRM-e](#)

Compatible R32 outdoor condensers:

[Mini SMMS](#), [SHRM-a](#)

Related items:

- [Full specification](#)
- [BIM files](#)
- [CAD files](#)
- [Airflow/ fan curve](#)
- [Dimensional drawing](#)
- [Wiring diagram](#)
- [Noise curve data](#)
- [Installation manual](#)



\*Awaiting Factory Confirmation

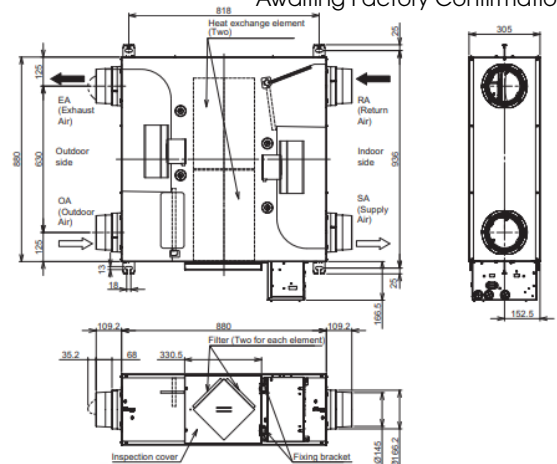

## VRF Air-to-Air Heat Exchanger: VN - U00501SY-E

- Expanded operating temperature range.
- Can be linked to the air conditioning system.
- Optional high performance air filter available.
- New DC Fan Motor provides flexible air volume.
- Complies ENTR lot 6 tier 2 requirements for the EU Market.



Hi - Res Image 



### Performance Data

Operating Range	Around Unit	°C - %RH	-10 to 50 - ≤ 80
	Outdoor Air	°C - %RH	-20 to 52 - ≤ 80
	Return Air	°C - %RH	5 to 40 - ≤ 80
Airflow	Standard Extra High - High - Low	l/s	138 - 111 - 72
	Standard Extra High - High - Low	m3/h	500 - 400 - 260
Fan	External Static Pressure Extra High - High - Low	Pa	125 - 80 - 39
	Specific Power Extra High - High - Low	W/l/s	1.3 - 0.9 - 0.7
Efficiency	Temperature Exchange Extra High - High - Low	%	74.0 - 74.5 - 77.0
	Enthalpy Exchange Efficiency Cooling Extra High - High - Low	%	79.0 - 79.5 - 80.5
	Enthalpy Exchange Efficiency Heating Extra High - High - Low	%	69.0 - 69.5 - 73.5
Sound	Pressure Extra High - High - Low	dB(A)	36.0 - 31.0 - 25.0
	Power Level Extra High - High - Low	dB(A)	51.0 - 46.0 - 40.0

### Indoor Data

Unit	Heat Exchanger		Special paper + Resin
	Filter Type		Non woven fabric
	Standard Air Filter		Gravitational method*
	High Efficiency Air Filter		Colorimetric method*
	Filtration Efficiency Grade (Collection Effect Weighing Method)	%	82
	Height x Width x Depth	mm	337 x 1020 x 920
Electrical	Weight	kg	47
	Duct Nominal Diameter Supply/Return	mm	200 x 2/200 x 2
	Power Input (Heat exchange mode) Extra High - High - Medium - Low	W	174 - 105 - 60 - 51
	Running Current Extra High - High - Medium - Low	Amps	1.32 - 0.85 - 0.51 - 0.43
	Maximum Run Current	Amps	1.32
	Power Supply	V/ph/Hz	220-240/1/50
	Suggested Fused Supply (with Heater Kit)	Amps	6 (16)
	Remote Controller Option		Wired 2-core non-polarity

### Accessories

<a href="#">NRC-01HE</a>	Dedicated air-to-air heat exchanger remote controller.
<a href="#">RBC-AMSU51-E</a>	Standard Remote Controller - Includes timer off, back light display, multilingual
<a href="#">RBC-AWSU52-E</a>	Premium Controller - Includes timer and back light display, multilingual (inc. Bluetooth)
<a href="#">RBC-VNMMH3</a>	Duct Heaters - For use with (0501, 0651)
<a href="#">TCB-SFMCA1V-E</a>	Multi Function Sensor (CO2/PM) - Compatible with all model sizes
<a href="#">TCB-PSFC551VLY-E</a>	High Performance Filter (Epm1 55%) - (0501, 0651)

\*All [Accessories](#) / [Controls](#)

Compatible R410a outdoor condensers:

[Mini SMMS-e](#), [SMMS-u](#), [SHRM-e](#)

Compatible R32 outdoor condensers:

[Mini SMMS](#), [SHRM-a](#)

Related items:

- [Full specification](#)
- [BIM files](#)
- [CAD files](#)
- [Airflow/ fan curve](#)
- [Dimensional drawing](#)
- [Wiring diagram](#)
- [Noise curve data](#)
- [Installation manual](#)



\*Awaiting Factory Confirmation

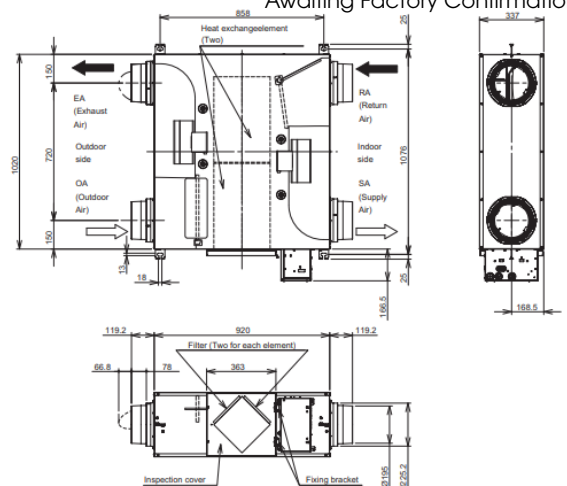

## VRF Air-to-Air Heat Exchanger: VN - U00651SY-E

- Expanded operating temperature range.
- Can be linked to the air conditioning system.
- Optional high performance air filter available.
- New DC Fan Motor provides flexible air volume.
- Complies ENTR lot 6 tier 2 requirements for the EU Market.



Hi - Res Image 



### Performance Data

Operating Range	Around Unit	°C - %RH	-10 to 50 - ≤ 80
	Outdoor Air	°C - %RH	-20 to 52 - ≤ 80
	Return Air	°C - %RH	5 to 40 - ≤ 80
Airflow	Standard Extra High - High - Low	l/s	180 - 144 - 88
	Standard Extra High - High - Low	m3/h	650 - 520 - 260
Fan	External Static Pressure Extra High - High - Low	Pa	150 - 100 - 29
	Specific Power Extra High - High - Low	W/l/s	1.7 - 1.2 - 0.6
Efficiency	Temperature Exchange Extra High - High - Low	%	70.0 - 72.0 - 76.0
	Enthalpy Exchange Efficiency Cooling Extra High - High - Low	%	77.0 - 77.5 - 79.0
	Enthalpy Exchange Efficiency Heating Extra High - High - Low	%	63.0 - 66.5 - 73.0
Sound	Pressure Extra High - High - Low	dB(A)	39.0 - 35.0 - 24.0
	Power Level Extra High - High - Low	dB(A)	54.0 - 50.0 - 39.0

### Indoor Data

Unit	Heat Exchanger		Special paper + Resin
	Filter Type		Non woven fabric
	Standard Air Filter		Gravitational method*
	High Efficiency Air Filter		Colorimetric method*
	Filtration Efficiency Grade (Collection Effect Weighing Method)	%	82
Electrical	Height x Width x Depth	mm	337 x 1020 x 920
	Weight	kg	47
	Duct Nominal Diameter Supply/Return	mm	200 x 2/200 x 2
	Power Input (Heat exchange mode) Extra High - High - Medium - Low	W	306 - 176 - 96 - 55
	Running Current Extra High - High - Medium - Low	Amps	2.16 - 1.33 - 0.78 - 0.46
	Maximum Run Current	Amps	2.16
	Power Supply	V/ph/Hz	220-240/1/50
	Suggested Fused Supply (with Heater Kit)	Amps	6 (16)
	Remote Controller Option		Wired 2-core non-polarity

### Accessories

<a href="#">NRC-01HE</a>	Dedicated air-to-air heat exchanger remote controller.
<a href="#">RBC-AMSU51-E</a>	Standard Remote Controller - Includes timer off, back light display, multilingual
<a href="#">RBC-AWSU52-E</a>	Premium Controller - Includes timer and back light display, multilingual (inc. Bluetooth)
<a href="#">RBC-VNMH3</a>	Duct Heaters - For use with (0501, 0651)
<a href="#">TCB-SFMCA1V-E</a>	Multi Function Sensor (CO2/PM) - Compatible with all model sizes
<a href="#">TCB-PSFC551VLY-E</a>	High Performance Filter (Epm1 55%) - (0501, 0651)

\*All [Accessories](#) / [Controls](#)

Compatible R410a outdoor condensers:

[Mini SMMS-e](#), [SMMS-u](#), [SHRM-e](#)

Compatible R32 outdoor condensers:

[Mini SMMS](#), [SHRM-a](#)

Related items:

- [Full specification](#)
- [BIM files](#)
- [CAD files](#)
- [Airflow/ fan curve](#)
- [Dimensional drawing](#)
- [Wiring diagram](#)
- [Noise curve data](#)
- [Installation manual](#)

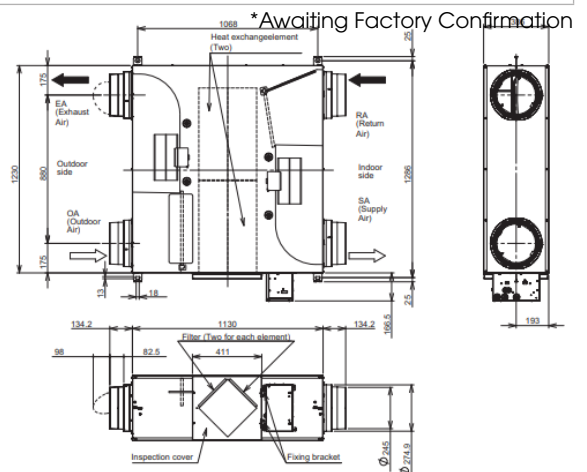



## VRF Air-to-Air Heat Exchanger: VN - U00801SY-E

- Expanded operating temperature range.
- Can be linked to the air conditioning system.
- Optional high performance air filter available.
- New DC Fan Motor provides flexible air volume.
- Complies ENTR lot 6 tier 2 requirements for the EU Market.



Hi - Res Image 



### Performance Data

Operating Range	Around Unit	°C - %RH	-10 to 50 - ≤ 80
	Outdoor Air	°C - %RH	-20 to 52 - ≤ 80
	Return Air	°C - %RH	5 to 40 - ≤ 80
Airflow	Standard Extra High - High - Low	l/s	222 - 177 - 111
	Standard Extra High - High - Low	m3/h	800 - 640 - 320
Fan	External Static Pressure Extra High - High - Low	Pa	145 - 92 - 28
	Specific Power Extra High - High - Low	W/l/s	1.5 - 1.1 - 0.6
Efficiency	Temperature Exchange Extra High - High - Low	%	72.5 - 74.5 - 88.5
	Enthalpy Exchange Efficiency Cooling Extra High - High - Low	%	78.0 - 79.0 - 91.0
	Enthalpy Exchange Efficiency Heating Extra High - High - Low	%	67.0 - 70.0 - 86.0
Sound	Pressure Extra High - High - Low	dB(A)	39.0 - 35.0 - 23.0
	Power Level Extra High - High - Low	dB(A)	54.0 - 50.0 - 38.0

### Indoor Data

Unit	Heat Exchanger		Special paper + Resin
	Filter Type		Non woven fabric
	Standard Air Filter		Gravitational method*
	High Efficiency Air Filter		Colorimetric method*
	Filtration Efficiency Grade (Collection Effect Weighing Method)	%	82
	Height x Width x Depth	mm	386 x 1230 x 1130
	Weight	kg	63
Electrical	Duct Nominal Diameter Supply/Return	mm	250 x 2/250 x 2
	Power Input (Heat exchange mode) Extra High - High - Medium - Low	W	328 - 196 - 114 - 62
	Running Current Extra High - High - Medium - Low	Amps	2.26 - 1.43 - 0.86 - 0.48
	Maximum Run Current	Amps	2.26
	Power Supply	V/ph/Hz	220-240/1/50
	Suggested Fused Supply (with Heater Kit)	Amps	6 (16)
	Remote Controller Option		Wired 2-core non-polarity

### Accessories

<a href="#">NRC-01HE</a>	Dedicated air-to-air heat exchanger remote controller.
<a href="#">RBC-AMSU51-E</a>	Standard Remote Controller - Includes timer off, back light display, multilingual
<a href="#">RBC-AWSU52-E</a>	Premium Controller - Includes timer and back light display, multilingual (inc. Bluetooth)
<a href="#">RBC-VNMH4</a>	Duct Heaters - For use with (0801, 1001)
<a href="#">TCB-SFMC1V-E</a>	Multi Function Sensor (CO2/PM) - Compatible with all model sizes
<a href="#">TCB-PSFC551VXY-E</a>	High Performance Filter (Epm1 55%) - (0801, 1001)

\*All [Accessories](#) / [Controls](#)

Compatible R410a outdoor condensers:

[Mini SMMS-e](#), [SMMS-u](#), [SHRM-e](#)

Compatible R32 outdoor condensers:

[Mini SMMS](#), [SHRM-a](#)

Related items:

- [Full specification](#)
- [BIM files](#)
- [CAD files](#)
- [Airflow/ fan curve](#)
- [Dimensional drawing](#)
- [Wiring diagram](#)
- [Noise curve data](#)
- [Installation manual](#)



\*Awaiting Factory Confirmation

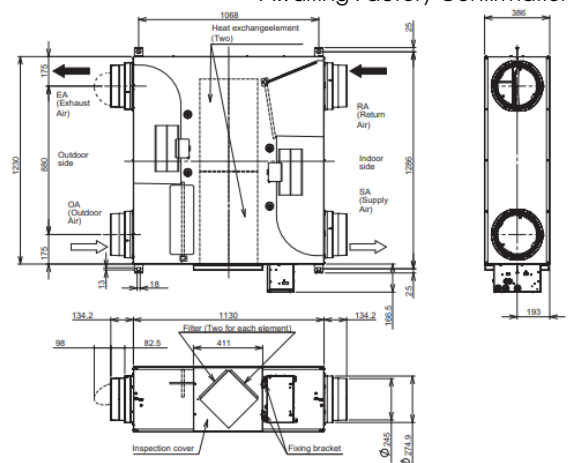

## VRF Air-to-Air Heat Exchanger: VN - U01001SY-E

- Expanded operating temperature range.
- Can be linked to the air conditioning system.
- Optional high performance air filter available.
- New DC Fan Motor provides flexible air volume.
- Complies ENTR lot 6 tier 2 requirements for the EU Market.



Hi - Res Image



### Performance Data

Operating Range	Around Unit	°C - %RH	-10 to 50 - ≤ 80
	Outdoor Air	°C - %RH	-20 to 52 - ≤ 80
	Return Air	°C - %RH	5 to 40 - ≤ 80
Airflow	Standard Extra High - High - Low	l/s	277 - 222 - 194
	Standard Extra High - High - Low	m3/h	1000 - 800 - 400
Fan	External Static Pressure Extra High - High - Low	Pa	170 - 110 - 30
	Specific Power Extra High - High - Low	W/l/s	1.9 - 1.3 - 0.4
Efficiency	Temperature Exchange Extra High - High - Low	%	70.5 - 71 - 84.0
	Enthalpy Exchange Efficiency Cooling Extra High - High - Low	%	78.0 - 78.5 - 87.0
	Enthalpy Exchange Efficiency Heating Extra High - High - Low	%	63.0 - 63.5 - 81.0
Sound	Pressure Extra High - High - Low	dB(A)	41.0 - 38.0 - 24.0
	Power Level Extra High - High - Low	dB(A)	56.0 - 53.0 - 39.0

### Indoor Data

Unit	Heat Exchanger		Special paper + Resin
	Filter Type		Non woven fabric
	Standard Air Filter		Gravitational method*
	High Efficiency Air Filter		Colorimetric method*
	Filtration Efficiency Grade (Collection Effect Weighing Method)	%	82
	Height x Width x Depth	mm	386 x 1230 x 1130
	Weight	kg	63
Electrical	Duct Nominal Diameter Supply/Return	mm	250 x 2/250 x 2
	Power Input (Heat exchange mode) Extra High - High - Medium - Low	W	541 - 291 - 151 - 74
	Running Current Extra High - High - Medium - Low	Amps	3.48 - 2.04 - 1.12 - 0.57
	Maximum Run Current	Amps	3.48
	Power Supply	V/ph/Hz	220-240/1/50
	Suggested Fused Supply (with Heater Kit)	Amps	10 (16)
	Remote Controller Option		Wired 2-core non-polarity

### Accessories

<a href="#">NRC-01HE</a>	Dedicated air-to-air heat exchanger remote controller.
<a href="#">RBC-AMSU51-E</a>	Standard Remote Controller - Includes timer off, back light display, multilingual.
<a href="#">RBC-AWSU52-E</a>	Premium Controller - Includes timer and back light display, multilingual (inc. Bluetooth)
<a href="#">RBC-VNMH4</a>	Duct Heaters - For use with (0801, 1001)
<a href="#">TCB-SFMC1V-E</a>	Multi Function Sensor (CO2/PM) - Compatible with all model sizes
<a href="#">TCB-PSFC551VXY-E</a>	High Performance Filter (Epm1 55%) - (0801, 1001)

\*All [Accessories](#) / [Controls](#)

Compatible R410a outdoor condensers:

[Mini SMMS-e, SMMS-u, SHRM-e](#)

Compatible R32 outdoor condensers:

[Mini SMMS, SHRM-a](#)

Related items:

- [Full specification](#)
- [BIM files](#)
- [CAD files](#)
- [Airflow/ fan curve](#)
- [Dimensional drawing](#)
- [Wiring diagram](#)
- [Noise curve data](#)
- [Installation manual](#)



\*Awaiting Factory Confirmation

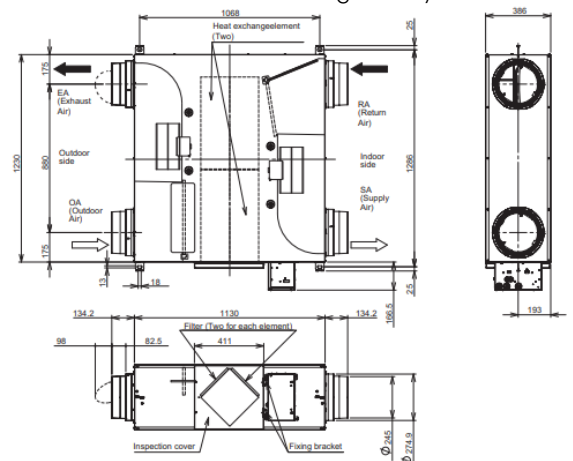

## VRF Air-to-Air Heat Exchanger: VN - M1500HE1

- Low noise level down to 36dB(A).
- Reclaims 20-50% of the energy lost by ventilation.
- Recovery of up to 75% heat from the outgoing air.
- Changes temperature and humidity of entering fresh air.
- Can be integrated into air conditioning systems, reduces size of overall system.



Hi - Res Image 



### Performance Data

Operating Range	Around Unit	°C - %RH	-10 to 40 - ≤ 80
	Outdoor Air	°C - %RH	-15 to 43 - ≤ 80
	Return Air	°C - %RH	5 to 40 - ≤ 80
Airflow	Standard Extra High - High - Low	l/s	417 - 417 - 333
	Standard Extra High - High - Low	m3/h	1500 - 1500 - 1200
Fan	External Static Pressure Extra High - High - Low	Pa	140 - 110 - 80
	Specific Power Extra High - High - Low	W/l/s	1.5 - 1.4 - 1.0
Efficiency	Temperature Exchange Extra High - High - Low	%	76.5 - 76.5 - 79.0
	Enthalpy Exchange Efficiency Cooling Extra High - High - Low	%	64.0 - 64.0 - 67.0
	Enthalpy Exchange Efficiency Heating Extra High - High - Low	%	71.0 - 71.0 - 73.5
Sound	Pressure Extra High - High - Low	dB(A)	41.0 - 40.0 - 36.0
	Power Level Extra High - High - Low	dB(A)	56.0 - 55.0 - 51.0

### Indoor Data

Unit	Heat Exchanger		Special paper + Resin
	Filter Type		Non woven fabric
	Standard Air Filter		Gravitational method*
	High Efficiency Air Filter		Colorimetric method*
	Filtration Efficiency Grade (Collection Effect Weighing Method)	%	82
	Height x Width x Depth	mm	1189 x 1189 x 810
	Weight	kg	126
Electrical	Duct Nominal Diameter Supply/Return	mm	250 x 4/283 x 730 x 2
	Power Input (Heat exchange mode) Extra High - High - Medium - Low	W	640 - 570 - 320
	Running Current Extra High - High - Medium - Low	Amps	4.32
	Maximum Run Current	Amps	5.08
	Power Supply	V/ph/Hz	220-240/1/50
	Suggested Fused Supply (with Heater Kit)	Amps	10 (16)
	Remote Controller Option		Wired 2-core non-polarity

### Accessories

<a href="#">NRC-01HE</a>	Dedicated air-to-air heat exchanger remote controller.
<a href="#">RBC-AMSU51-E</a>	Standard Remote Controller - Includes timer off, back light display, multilingual.
<a href="#">RBC-AMTU31-E</a>	Standard Remote Controller - Full control including service functions
<a href="#">RBC-SMCN61</a>	Remote switch on/off and lock functions (for use with VN-M1500HE1, VN-M200HE1)
<a href="#">RBC-VNMC-HE1</a>	Heater Kit Controller
<a href="#">TCB-PCUC2E</a>	Indoor Control Interface

\*All [Accessories](#) / [Controls](#)

Compatible R410a outdoor condensers:

[Mini SMMS-e](#), [SMMS-u](#), [SHRM-e](#)

Compatible R32 outdoor condensers:

[Mini SMMS](#), [SHRM-a](#)

Related items:

- [Full specification](#)
- [BIM files](#)
- [CAD files](#)
- [Airflow/ fan curve](#)
- [Dimensional drawing](#)
- [Wiring diagram](#)
- [Noise curve data](#)
- [Installation manual](#)

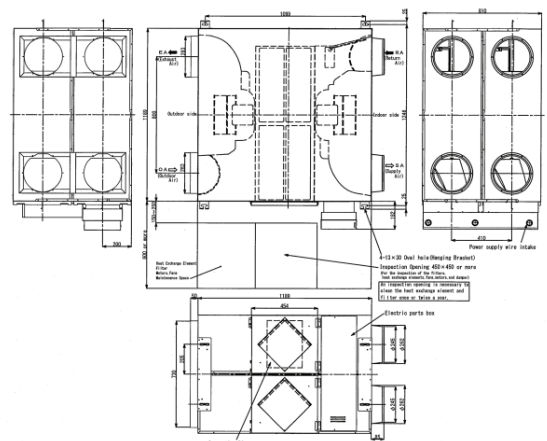

## VRF Air-to-Air Heat Exchanger: VN - M2000HE1

- Low noise level down to 36dB(A).
- Reclaims 20-50% of the energy lost by ventilation.
- Recovery of up to 75% heat from the outgoing air.
- Changes temperature and humidity of entering fresh air.
- Can be integrated into air conditioning systems, reduces size of overall system.



Hi - Res Image



### Performance Data

Operating Range	Around Unit	°C - %RH	-10 to 40 - ≤ 80
	Outdoor Air	°C - %RH	-15 to 43 - ≤ 80
	Return Air	°C - %RH	5 to 40 - ≤ 80
Airflow	Standard Extra High - High - Low	l/s	555 - 555 - 388
	Standard Extra High - High - Low	m3/h	2000 - 2000 - 1400
Fan	External Static Pressure Extra High - High - Low	Pa	105 - 80 - 70
	Specific Power Extra High - High - Low	W/l/s	1.4 - 1.2 - 1.0
Efficiency	Temperature Exchange Extra High - High - Low	%	73.5 - 73.5 - 77.5
	Enthalpy Exchange Efficiency Cooling Extra High - High - Low	%	60.5 - 60.5 - 65.5
	Enthalpy Exchange Efficiency Heating Extra High - High - Low	%	68.5 - 68.5 - 72.0
Sound	Pressure Extra High - High - Low	dB(A)	41.5 - 40.5 - 36.5
	Power Level Extra High - High - Low	dB(A)	56.5 - 55.5 - 51.5

### Indoor Data

Unit	Heat Exchanger		Special paper + Resin
	Filter Type		Non woven fabric
	Standard Air Filter		Gravitational method*
	High Efficiency Air Filter		Colorimetric method*
	Filtration Efficiency Grade (Collection Effect Weighing Method)	%	82
	Height x Width x Depth	mm	1189 x 1189 x 810
	Weight	kg	126
Electrical	Duct Nominal Diameter Supply/Return	mm	250 x 4/283 x 730 x 2
	Power Input (Heat exchange mode) Extra High - High - Medium - Low	W	780 - 680 - 380
	Running Current Extra High - High - Medium - Low	Amps	4.8
	Maximum Run Current	Amps	5.08
	Power Supply	V/ph/Hz	220-240/1/50
	Suggested Fused Supply (with Heater Kit)	Amps	10 (20)
	Remote Controller Option		Wired 2-core non-polarity

### Accessories

<a href="#">NRC-01HE</a>	Dedicated air-to-air heat exchanger remote controller.
<a href="#">RBC-AMSU51-E</a>	Standard Remote Controller - Includes timer off, back light display, multilingual.
<a href="#">RBC-AMTU31-E</a>	Standard Remote Controller - Full control including service functions
<a href="#">RBC-SMCN61</a>	Remote switch on/off and lock functions (for use with VN-M1500HE1, VN-M200HE1)
<a href="#">RBC-VNMC-HE1</a>	Heater Kit Controller
<a href="#">TCB-PCUC2E</a>	Indoor Control Interface

\*All [Accessories](#) / [Controls](#)

Compatible R410a outdoor condensers:

[Mini SMMS-e](#), [SMMS-u](#), [SHRM-e](#)

Compatible R32 outdoor condensers:

[Mini SMMS](#), [SHRM-a](#)

Related items:

- [Full specification](#)
- [BIM files](#)
- [CAD files](#)
- [Airflow/ fan curve](#)
- [Dimensional drawing](#)
- [Wiring diagram](#)
- [Noise curve data](#)
- [Installation manual](#)

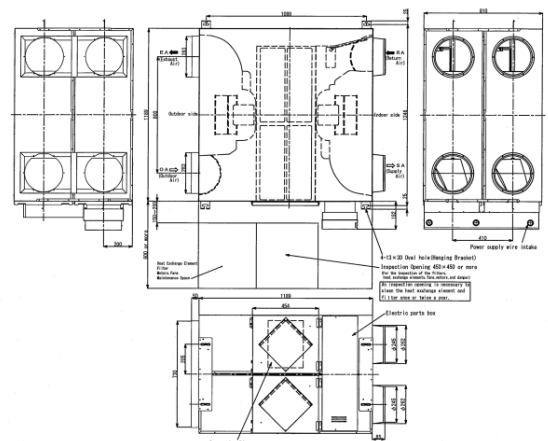

# HOT WATER MODULE



## VRF MID TEMPERATURE HOT WATER MODULE: MMW - UP0271LQ-E

- Operating range from -25°C WB to 19°C WB.
- Up to 200% diversity indoor units & hot water module.
- Compatible with both space heating and domestic hot water applications.
- Light and compact chassis to simplify the handling and the project integration.
- Designed to produce hot water from 25°C up to 50°C outlet water temperature.



Hi - Res Image



### Performance Data

Capacity Code		HP	2.5
Nominal	<b>Heating Capacity</b>		<b>8.0</b>
Operating Modes		HEATING	
Heating	Operating Ambient Range	°C WB	-25 - 19
	Water inlet	°C	15 - 45
	Operation Water Side (min. - max.)	°C	25 - 50
Electrical	Power Input	kW	0.014
	Run Current	Amps	0.080

### Indoor Data

Sound Pressure		dB(A)	25
Unit	Height x Width x Depth	mm	580 x 400 x 250
	Weight	kg	18
Pipe Connection	Flare Connections (gas - liquid)	inch	5/8 - 3/8
	Water Flow & Return	mm	R1-1/4 (PT1-1/4 Screw)
Refrigerant	Type		R410A
	Charge Amount (liquid pipe length)	kg	Std VRF calculation
	Circulating Pump (not included)		Local Procurement
	Heat Exchanger Type		Plate
Water	Design Pressure Refrigerant	mPa	3.73
	Design Pressure Water	mPa	1
	Nominal Flow Rate	l/min	22.9
	Min. - Max. Flow Rate	l/min	19.5 - 26.3
	Pressure Drop Min. - Std. - Max.	Kpa	28.5 - 40.5 - 53.5
	ΔT	°C	5
Power Supply	Suggested Fuse Size	V/ph/Hz-A	220-240/1/50-5

### Accessories

<a href="#">RBC-AMTU31-E</a>	Standard Remote Controller - Full control including service functions
<a href="#">RBC-ASCU11-E</a>	Compact Remote Controller - Includes timer off, back light display, multilingual
<a href="#">RBC-AWSU52-E</a>	Premium Controller - Includes timer and back light display, multilingual (inc. Bluetooth)
<a href="#">RBC-MTSC1</a>	Mini Touch Screen Controller - with configurable icons for indoor units
<a href="#">RBC-MTSC2</a>	Mini Touch Screen Controller - with Schedule Timer, configurable icons for indoor units

\*All [Accessories](#) / [Controls](#)

Compatible R410a outdoor condensers:

[Mini SMMS-e](#), [SMMS-u](#), [SHRM-e](#)

Compatible R32 outdoor condensers:

[Mini SMMS](#), [SHRM-a](#)

Related items:

- [Full specification](#)
- [BIM files](#)
- [CAD files](#)
- [Flow rate and pressure loss](#)
- [Booster heater selection](#)
- [Dimensional drawing](#)
- [Wiring diagram](#)
- [Noise curve data](#)
- [Installation manual](#)

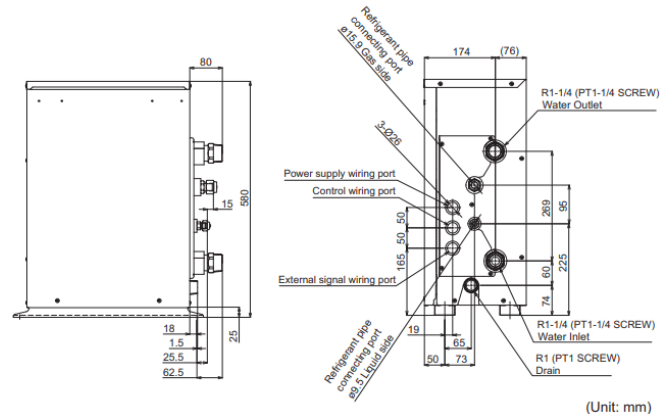

(Unit: mm)

## VRF MID TEMPERATURE HOT WATER MODULE: MMW - UP0561LQ-E

- Operating range from -25°C WB to 19°C WB.
- Up to 200% diversity indoor units & hot water module.
- Compatible with both space heating and domestic hot water applications.
- Light and compact chassis to simplify the handling and the project integration.
- Designed to produce hot water from 25°C up to 50°C outlet water temperature.



Hi - Res Image

### Performance Data

Capacity Code		HP	5.0
Nominal	<b>Heating Capacity</b>		<b>16.0</b>
Operating Modes		HEATING	
Heating	Operating Ambient Range	°C WB	-25 - 19
	Water inlet	°C	15 - 45
	Operation Water Side (min. - max.)	°C	25 - 50
Electrical	Power Input	kW	0.014
	Run Current	Amps	0.080

### Indoor Data

Sound Pressure		dB(A)	27
Unit	Height x Width x Depth	mm	580 x 400 x 250
	Weight	kg	20
Pipe Connection	Flare Connections (gas - liquid)	inch	5/8 - 3/8
	Water Flow & Return	mm	R1-1/4 (PT1-1/4 Screw)
Refrigerant	Type		R410A
	Charge Amount (liquid pipe length)	kg	Std VRF calculation
	Circulating Pump (not included)		Local Procurement
	Heat Exchanger Type		Plate
Water	Design Pressure Refrigerant	mPa	3.73
	Design Pressure Water	mPa	1
	Nominal Flow Rate	l/min	45.8
	Min. - Max. Flow Rate	l/min	38.9 - 52.6
	Pressure Drop Min. - Std. - Max.	Kpa	35.2 - 44.2 - 58.2
	ΔT	°C	5
Power Supply	Suggested Fuse Size	V/ph/Hz-A	220-240/1/50-5

### Accessories

<a href="#">RBC-AMTU31-E</a>	Standard Remote Controller - Full control including service functions
<a href="#">RBC-ASCU11-E</a>	Compact Remote Controller - Includes timer off, back light display, multilingual
<a href="#">RBC-AWSU52-E</a>	Premium Controller - Includes timer and back light display, multilingual (inc. Bluetooth)
<a href="#">RBC-MTSC1</a>	Mini Touch Screen Controller - with configurable icons for indoor units
<a href="#">RBC-MTSC2</a>	Mini Touch Screen Controller - with Schedule Timer, configurable icons for indoor units

\*All [Accessories](#) / [Controls](#)

Compatible R410a outdoor condensers:

[Mini SMMS-e](#), [SMMS-u](#), [SHRM-e](#)

Compatible R32 outdoor condensers:

[Mini SMMS](#), [SHRM-a](#)

Related items:

- [Full specification](#)
- [BIM files](#)
- [CAD files](#)
- [Flow rate and pressure loss](#)
- [Booster heater selection](#)
- [Dimensional drawing](#)
- [Wiring diagram](#)
- [Noise curve data](#)
- [Installation manual](#)

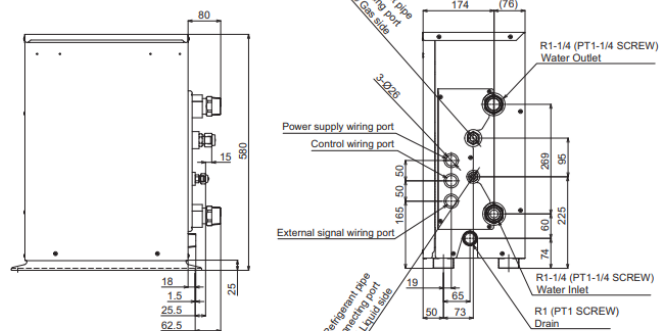

(Unit: mm)

## VRF HIGH TEMPERATURE HOT WATER MODULE: MMW - AP0481CHQ-E

- For use with SHRMe.
- Operating range from -25°C to +46°C DB ambient condition.
- Still maintaining the performance and efficiency levels of the rest of the system.
- Designed to produce hot water from 25°C up to 82°C outlet water temperature.
- Suited for hot water sanitary production for residential and business applications.



Hi - Res Image

### Performance Data

Capacity Code	HP	4.5	
	Nominal Capacity	kW	14.0
	Water Temperature (up to)	°C	85
	Operating Ambient Range	°C	-25 - 46
	Operation Indoor (min. - max.)	°C	5 - 32
Electrical	Power Input	kW	4.15
	Run Current	Amps	17.5

### Indoor Data

Sound Pressure		dB(A)	44
Unit	Height x Width x Depth	mm	700 x 900 x 320
	Weight	kg	100
Pipe Connection	Flare Connections (gas - liquid)	inch	5/8 - 3/8
	Water Flow & Return	mm	R1-1/4 (PT1-1/4 Screw)
Refrigerant	Type		R134A
	Charge Amount (liquid pipe length)	kg	2.1
Water	Circulating Pump (not included)		Local Procurement
	Hydronic Components		Local Procurement
	Design Pressure	mPa	1.00
	Nominal Flow Rate	l/min	40.0
Power Supply	Suggested Fuse Size	V/ph/Hz-A	220-240/1/50-5

\* Model MMW-AP0481CHQ-E not connectable to SMMS-u or SHRM-Advance

### Accessories

<a href="#">RBC-AMTU31-E</a>	Standard Remote Controller - Full control including service functions
<a href="#">RBC-ASCU11-E</a>	Compact Remote Controller - Includes timer off, back light display, multilingual
<a href="#">RBC-AWSU52-E</a>	Premium Controller - Includes timer and back light display, multilingual (inc. Bluetooth)
<a href="#">RBC-MTSC1</a>	Mini Touch Screen Controller - with configurable icons for indoor units
<a href="#">RBC-MTSC2</a>	Mini Touch Screen Controller - with Schedule Timer, configurable icons for indoor units

\*All [Accessories](#) / [Controls](#)

Compatible R410a outdoor condensers:

[Mini SMMS-e](#), [SHRM-e](#)

Compatible R32 outdoor condensers:

[Mini SMMS](#)

Related items:

- [Full specification](#)
- [BIM files](#)
- [CAD files](#)
- [Flow rate and pressure loss](#)
- [Booster heater selection](#)
- [Dimensional drawing](#)
- [Wiring diagram](#)
- [Noise curve data](#)
- [Installation manual](#)

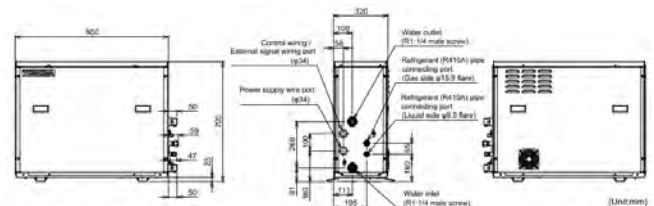





# MINI SMMSe



## VRF MINI SMMS<sub>e</sub> R410A: MCY - MHP0406HT-E

### STAND ALONE - SINGLE FAN

- SEER up to: 8.08 COP up to: 3.88.
- Compact and lightweight outdoor unit.
- High-efficiency DC twin rotary compressor.
- Extended refrigerant piping capability (90m).
- Operates up to 8 indoor units from a choice of over 80 models.



Hi - Res Image 

### Performance & Outdoor Data

Capacity Range		HP	4
Maximum Number of Indoor Units		QTY	8
Cooling Capacity		kW	12.1
Heating Capacity		kW	12.5
Operating Range	Cooling	°C	-5.0 to 46.0
	Heating		-20.0 to 15.0
Cooling	Power Consumption	kW	3.24
	EER/SEER/Energy Efficiency Class (or nsc %)		3.73/8.08/320.2
Heating	Power Consumption	kW	2.83
	COP/SCOP/Energy Efficiency Class (or nsc (A) %)		4.42/3.83/150.2
Fan(s)	Standard Air Flow	l/s	1117
	Standard Air Flow	m <sup>3</sup> /h	4020
Sound	Pressure Level C/H	dB(A)	54/57
	Power Level C/H	dB(A)	71/74
Unit(s)	Height x Width x Depth	mm	910 x 990 x 390
	Weight	kg	100
Pipe Connections	Refrigerant Base Charge	kg	3.3
	Suction Gas Pipe Flare	inch	5/8
	Liquid Pipe Flare	inch	3/8
	Equivalent Length	m	60
	Real Length	m	50
	Total Pipe Length (Liquid Line Real Length)	m	90
	Length To First Branch	m	30
Maximum	Real Length of Indoor Unit Connecting Piping	m	10
	Height Difference Outdoor Higher Than Indoor Units	m	15
	Height Difference Outdoor Lower Than Indoor Units	m	15
	Height Difference Between Indoor Units	m	10
	Electrical Characteristic Running Current Cooling/Heating	A	14.4/13.4
Electrical	Power Supply Wiring Starting Current	A	Soft Start
	Power Supply	V-ph-Hz	220/240-1-50
	Suggested Fused Supply(s)	A	20

\*All [Accessories](#) / [Controls](#)

### Related items:

- [Full specification](#)
- [BIM files](#)
- [CAD files](#)
- [Refrigerant Cycle](#)
- [Dimensional drawing](#)
- [Wiring diagram](#)
- [Noise curve data](#)
- [Installation manual](#)

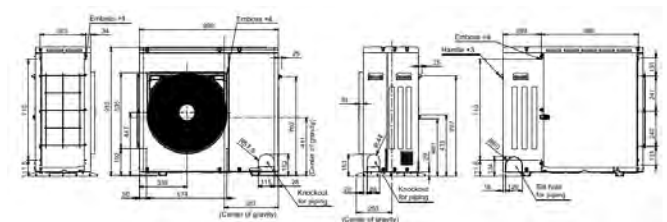

## VRF MINI SMMS<sub>e</sub> R410A: MCY - MHP0506HT-E1

### STAND ALONE - SINGLE FAN

- SEER up to: 7.77 COP up to: 3.86.
- Compact and lightweight outdoor unit.
- High-efficiency DC twin rotary compressor.
- Extended refrigerant piping capability (90m).
- Operates up to 10 indoor units from a choice of over 80 models.



Hi - Res Image 

### Performance & Outdoor Data

Capacity Range		HP	5
Maximum Number of Indoor Units		QTY	10
Cooling Capacity		kW	14.0
Heating Capacity		kW	16.0
Operating Range	Cooling	°C	-5.0 to 46.0
	Heating		-20.0 to 15.0
Cooling	Power Consumption	kW	4.34
	EER/SEER/Energy Efficiency Class (or nsc %)		3.23/7.77/307.8
Heating	Power Consumption	kW	3.86
	COP/SCOP/Energy Efficiency Class (or nsc (A) %)		4.00/3.86/152.2
Fan(s)	Standard Air Flow	l/s	1183
	Standard Air Flow	m <sup>3</sup> /h	4260
Sound	Pressure Level C/H	dB(A)	54/58
	Power Level C/H	dB(A)	71/75
Unit(s)	Height x Width x Depth	mm	910 x 990 x 390
	Weight	kg	100
Pipe Connections	Refrigerant Base Charge	kg	3.3
	Suction Gas Pipe Flare	inch	5/8
	Liquid Pipe Flare	inch	3/8
	Equivalent Length	m	60
	Real Length	m	50
	Total Pipe Length (Liquid Line Real Length)	m	90
	Length To First Branch	m	30
Maximum	Real Length of Indoor Unit Connecting Piping	m	10
	Height Difference Outdoor Higher Than Indoor Units	m	15
	Height Difference Outdoor Lower Than Indoor Units	m	15
	Height Difference Between Indoor Units	m	10
Electrical	Electrical Characteristic Running Current Cooling/Heating	A	21.0/19.1
	Power Supply Wiring Starting Current	A	Soft Start
	Power Supply	V-ph-Hz	220/240-1-50
	Suggested Fused Supply(s)	A	25

\*All [Accessories](#) / [Controls](#)

### Related items:

- [Full specification](#)
- [BIM files](#)
- [CAD files](#)
- [Refrigerant Cycle](#)
- [Dimensional drawing](#)
- [Wiring diagram](#)
- [Noise curve data](#)
- [Installation manual](#)

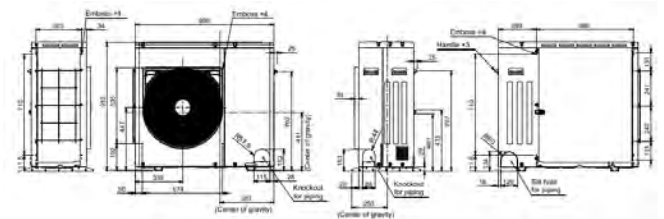

## VRF MINI SMMS<sub>e</sub> R410A: MCY - MHP0404HS-E

### STAND ALONE - TWIN FAN

- SEER up to: 9.42 COP up to: 4.17.
- High-efficiency DC twin rotary compressor.
- Extended refrigerant piping capability (180m).
- Compact twin fan chassis and lightweight outdoor unit.
- Operates up to 8 indoor units from a choice of over 80 models.



Hi - Res Image 

### Performance & Outdoor Data

Capacity Range		HP	4
Maximum Number of Indoor Units		QTY	8
Cooling Capacity		kW	12.1
Heating Capacity		kW	12.5
Operating Range	Cooling	°C	-5.0 to 46.0
	Heating		-20.0 to 15.0
Cooling	Power Consumption	kW	2.83
	EER/SEER/Energy Efficiency Class (or nsc %)		4.28/9.42/373.8
Heating	Power Consumption	kW	2.59
	COP/SCOP/Energy Efficiency Class (or nsc (A) %)		4.83/4.17/163.8
Fan(s)	Standard Air Flow	l/s	1572
	Standard Air Flow	m <sup>3</sup> /h	5660
Sound	Pressure Level C/H	dB(A)	49/52
	Power Level C/H	dB(A)	66/69
Unit(s)	Height x Width x Depth	mm	1235 x 990 x 390
	Weight	kg	127
Pipe Connections	Refrigerant Base Charge	kg	6.4
	Suction Gas Pipe Flare	inch	5/8
Maximum	Liquid Pipe Flare	inch	3/8
	Equivalent Length	m	125
	Real Length	m	100
	Total Pipe Length (Liquid Line Real Length)	m	180
	Length To First Branch	m	65
	Real Length of Indoor Unit Connecting Piping	m	15
	Height Difference Outdoor Higher Than Indoor Units	m	30
Electrical	Height Difference Outdoor Lower Than Indoor Units	m	20
	Height Difference Between Indoor Units	m	15
Electrical	Electrical Characteristic Running Current Cooling/Heating	A	13.0/12.0
	Power Supply Wiring Starting Current	A	Soft Start
	Power Supply	V-ph-Hz	220/240-1-50
	Suggested Fused Supply(s)	A	20

\*All [Accessories](#) / [Controls](#)

### Related items:

- [Full specification](#)
- [BIM files](#)
- [Refrigerant Cycle](#)
- [Dimensional drawing](#)
- [Wiring diagram](#)
- [Noise curve data](#)
- [Installation manual](#)

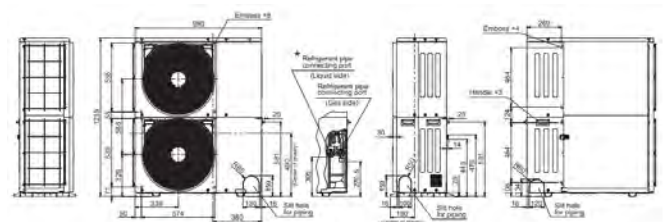

## VRF MINI SMMS<sub>e</sub> R410A: MCY - MHP0504HS-E

### STAND ALONE - TWIN FAN

- SEER up to: 9.23 COP up to: 4.24.
- High-efficiency DC twin rotary compressor.
- Extended refrigerant piping capability (180m).
- Compact twin fan chassis and lightweight outdoor unit.
- Operates up to 8 indoor units from a choice of over 80 models.



Hi - Res Image

### Performance & Outdoor Data

Capacity Range		HP	5
Maximum Number of Indoor Units		QTY	10
Cooling Capacity		kW	14.0
Heating Capacity		kW	16.0
Operating Range	Cooling	°C	-5.0 to 46.0
	Heating		-20.0 to 15.0
Cooling	Power Consumption	kW	3.50
	EER/SEER/Energy Efficiency Class (or nsc %)		4.00/9.23/366.2
Heating	Power Consumption	kW	3.75
	COP/SCOP/Energy Efficiency Class (or nsc (A) %)		4.27/4.24/166.6
Fan(s)	Standard Air Flow	l/s	1617
	Standard Air Flow	m <sup>3</sup> /h	5820
Sound	Pressure Level C/H	dB(A)	50/53
	Power Level C/H	dB(A)	68/70
Unit(s)	Height x Width x Depth	mm	1235 x 990 x 390
	Weight	kg	127
Pipe Connections	Refrigerant Base Charge	kg	6.4
	Suction Gas Pipe Flare	inch	5/8
Maximum	Liquid Pipe Flare	inch	3/8
	Equivalent Length	m	125
	Real Length	m	100
	Total Pipe Length (Liquid Line Real Length)	m	180
	Length To First Branch	m	65
	Real Length of Indoor Unit Connecting Piping	m	15
	Height Difference Outdoor Higher Than Indoor Units	m	30
Electrical	Height Difference Outdoor Lower Than Indoor Units	m	20
	Height Difference Between Indoor Units	m	15
Electrical	Electrical Characteristic Running Current Cooling/Heating	A	15.9/17.0
	Power Supply Wiring Starting Current	A	Soft Start
	Power Supply	V-ph-Hz	220/240-1-50
	Suggested Fused Supply(s)	A	25

\*All [Accessories](#) / [Controls](#)

### Related items:

- [Full specification](#)
- [BIM files](#)
- [Refrigerant Cycle](#)
- [Dimensional drawing](#)
- [Wiring diagram](#)
- [Noise curve data](#)
- [Installation manual](#)

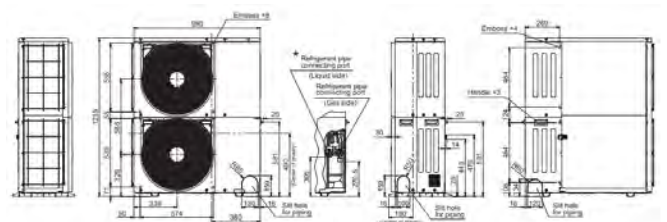

## VRF MINI SMMS<sub>e</sub> R410A: MCY - MHP0604HS-E

### STAND ALONE - TWIN FAN

- SEER up to: 9.42 COP up to: 4.17.
- High-efficiency DC twin rotary compressor.
- Extended refrigerant piping capability (180m).
- Compact twin fan chassis and lightweight outdoor unit.
- Operates up to 13 indoor units from a choice of over 80 models.



Hi - Res Image

### Performance & Outdoor Data

Capacity Range		HP	6
Maximum Number of Indoor Units		QTY	13
Cooling Capacity		kW	15.5
Heating Capacity		kW	18.0
Operating Range	Cooling	°C	-5.0 to 46.0
	Heating		-20.0 to 15.0
Cooling	Power Consumption	kW	4.29
	EER/SEER/Energy Efficiency Class (or nsc %)		3.61/9.68/384.2
Heating	Power Consumption	kW	4.31
	COP/SCOP/Energy Efficiency Class (or nsc (A) %)		4.18/4.37/171.8
Fan(s)	Standard Air Flow	l/s	1681
	Standard Air Flow	m <sup>3</sup> /h	6050
Sound	Pressure Level C/H	dB(A)	51/54
	Power Level C/H	dB(A)	68/71
Unit(s)	Height x Width x Depth	mm	1235 x 990 x 390
	Weight	kg	127
Pipe Connections	Refrigerant Base Charge	kg	6.4
	Suction Gas Pipe Flare	inch	3/4
Maximum	Liquid Pipe Flare	inch	3/8
	Equivalent Length	m	125
	Real Length	m	100
	Total Pipe Length (Liquid Line Real Length)	m	180
	Length To First Branch	m	65
	Real Length of Indoor Unit Connecting Piping	m	15
	Height Difference Outdoor Higher Than Indoor Units	m	30
	Height Difference Outdoor Lower Than Indoor Units	m	20
Electrical	Height Difference Between Indoor Units	m	15
	Electrical Characteristic Running Current Cooling/Heating	A	19.2/19.3
	Power Supply Wiring Starting Current	A	Soft Start
	Power Supply	V-ph-Hz	220/240-1-50
	Suggested Fused Supply(s)	A	25

\*All [Accessories](#) / [Controls](#)

### Related items:

- [Full specification](#)
- [BIM files](#)
- [Refrigerant Cycle](#)
- [Dimensional drawing](#)
- [Wiring diagram](#)
- [Noise curve data](#)
- [Installation manual](#)

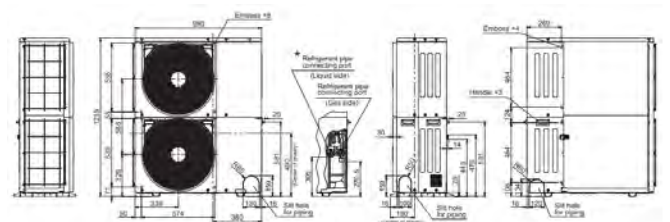

## VRF MINI SMMS<sub>e</sub> R410A: MCY - MHP0404HS8-E

### STAND ALONE - TWIN FAN

- SEER up to: 9.47 COP up to: 4.19.
- High-efficiency DC twin rotary compressor.
- Extended refrigerant piping capability (180m).
- Compact twin fan chassis and lightweight outdoor unit.
- Operates up to 8 indoor units from a choice of over 80 models.



Hi - Res Image 

Performance & Outdoor Data		
Capacity Range	HP	4
Maximum Number of Indoor Units	QTY	8
Cooling Capacity	kW	12.1
Heating Capacity	kW	12.5
Operating Range	Cooling	°C
	Heating	
Cooling	Power Consumption	kW
	EER/SEER/Energy Efficiency Class (or nsc %)	
Heating	Power Consumption	kW
	COP/SCOP/Energy Efficiency Class (or nsc (A) %)	
Fan(s)	Standard Air Flow	l/s
	Standard Air Flow	m <sup>3</sup> /h
Sound	Pressure Level C/H	dB(A)
	Power Level C/H	dB(A)
Unit(s)	Height x Width x Depth	mm
	Weight	kg
Pipe Connections	Refrigerant Base Charge	kg
	Suction Gas Pipe Flare	inch
Maximum	Liquid Pipe Flare	inch
	Equivalent Length	m
	Real Length	m
	Total Pipe Length (Liquid Line Real Length)	m
	Length To First Branch	m
	Real Length of Indoor Unit Connecting Piping	m
	Height Difference Outdoor Higher Than Indoor Units	m
	Height Difference Outdoor Lower Than Indoor Units	m
	Height Difference Between Indoor Units	m
	Electrical	Electrical Characteristic Running Current Cooling/Heating
Power Supply Wiring Starting Current		A
Power Supply		V-ph-Hz
Suggested Fused Supply(s)		A

\*All [Accessories](#) / [Controls](#)

### Related items:

- [Full specification](#)
- [BIM files](#)
- [CAD files](#)
- [Refrigerant Cycle](#)
- [Dimensional drawing](#)
- [Wiring diagram](#)
- [Noise curve data](#)
- [Installation manual](#)

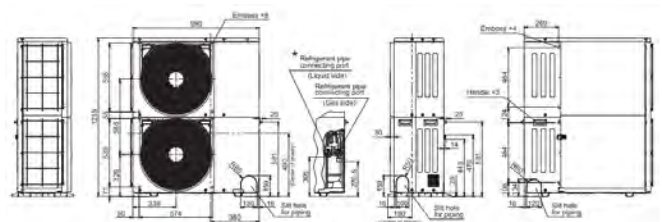

## VRF MINI SMMS<sub>e</sub> R410A: MCY - MHP0504HS8-E

### STAND ALONE - TWIN FAN

- SEER up to: 9.29 COP up to: 4.25.
- High-efficiency DC twin rotary compressor.
- Extended refrigerant piping capability (180m).
- Compact twin fan chassis and lightweight outdoor unit.
- Operates up to 13 indoor units from a choice of over 80 models.



Hi - Res Image 

### Performance & Outdoor Data

Capacity Range		HP	5
Maximum Number of Indoor Units		QTY	10
Cooling Capacity		kW	14
Heating Capacity		kW	16
Operating Range	Cooling	°C	-5.0 to 46.0
	Heating		-20.0 to 15.0
Cooling	Power Consumption	kW	3.47
	EER/SEER/Energy Efficiency Class (or nsc %)		4.03/9.29/167.0
Heating	Power Consumption	kW	3.72
	COP/SCOP/Energy Efficiency Class (or nsc (A) %)		4.30/4.25/167.0
Fan(s)	Standard Air Flow	l/s	1617
	Standard Air Flow	m <sup>3</sup> /h	5820
Sound	Pressure Level C/H	dB(A)	50/53
	Power Level C/H	dB(A)	68/69
Unit(s)	Height x Width x Depth	mm	1235 x 990 x 390
	Weight	kg	125
Pipe Connections	Refrigerant Base Charge	kg	6.4
	Suction Gas Pipe Flare	inch	5/8
Maximum	Liquid Pipe Flare	inch	3/8
	Equivalent Length	m	125
	Real Length	m	100
	Total Pipe Length (Liquid Line Real Length)	m	180
	Length To First Branch	m	65
	Real Length of Indoor Unit Connecting Piping	m	15
	Height Difference Outdoor Higher Than Indoor Units	m	30
	Height Difference Outdoor Lower Than Indoor Units	m	20
Electrical	Height Difference Between Indoor Units	m	15
	Electrical Characteristic Running Current Cooling/Heating	A	5.40/5.80
	Power Supply Wiring Starting Current	A	Soft Start
	Power Supply	V-ph-Hz	380-415/3/50
	Suggested Fused Supply(s)	A	16

\*All [Accessories](#) / [Controls](#)

### Related items:

- [Full specification](#)
- [BIM files](#)
- [CAD files](#)
- [Refrigerant Cycle](#)
- [Dimensional drawing](#)
- [Wiring diagram](#)
- [Noise curve data](#)
- [Installation manual](#)

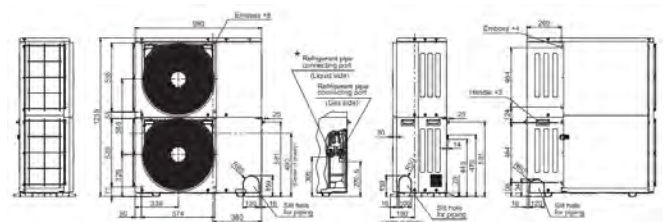



## VRF MINI SMMS<sub>e</sub> R410A: MCY - MHP0604HS8-E

### STAND ALONE - TWIN FAN

- SEER up to: 9.74 COP up to: 4.38.
- High-efficiency DC twin rotary compressor.
- Extended refrigerant piping capability (180m).
- Compact twin fan chassis and lightweight outdoor unit.
- Operates up to 13 indoor units from a choice of over 80 models.



Hi - Res Image 

### Performance & Outdoor Data

Capacity Range		HP	6
Maximum Number of Indoor Units		QTY	13
Cooling Capacity		kW	15.5
Heating Capacity		kW	18
Operating Range	Cooling	°C	-5.0 to 46.0
	Heating		-20.0 to 15.0
Cooling	Power Consumption	kW	4.25
	EER/SEER/Energy Efficiency Class (or nsc %)		3.65/9.74/172.2
Heating	Power Consumption	kW	4.27
	COP/SCOP/Energy Efficiency Class (or nsc (A) %)		4.22/4.38/172.2
Fan(s)	Standard Air Flow	l/s	1681
	Standard Air Flow	m <sup>3</sup> /h	6050
Sound	Pressure Level C/H	dB(A)	51/54
	Power Level C/H	dB(A)	68/70
Unit(s)	Height x Width x Depth	mm	1235 x 990 x 390
	Weight	kg	125
Pipe Connections	Refrigerant Base Charge	kg	6.4
	Suction Gas Pipe Flare	inch	3/4
Maximum	Liquid Pipe Flare	inch	3/8
	Equivalent Length	m	125
	Real Length	m	100
	Total Pipe Length (Liquid Line Real Length)	m	180
	Length To First Branch	m	65
	Real Length of Indoor Unit Connecting Piping	m	15
	Height Difference Outdoor Higher Than Indoor Units	m	30
	Height Difference Outdoor Lower Than Indoor Units	m	20
	Height Difference Between Indoor Units	m	15
	Electrical	Electrical Characteristic Running Current Cooling/Heating	A
Power Supply Wiring Starting Current		A	Soft Start
Power Supply		V-ph-Hz	380-415/3/50
Suggested Fused Supply(s)		A	16

\*All [Accessories](#) / [Controls](#)

### Related items:

- [Full specification](#)
- [BIM files](#)
- [CAD files](#)
- [Refrigerant Cycle](#)
- [Dimensional drawing](#)
- [Wiring diagram](#)
- [Noise curve data](#)
- [Installation manual](#)

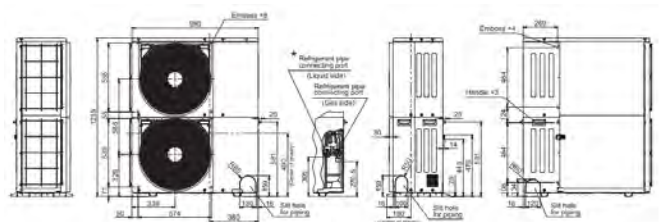

## VRF MINI SMMS<sub>e</sub> R410A: MCY - MHP0806HS8-E

### STAND ALONE - TWIN FAN

- SEER up to: 8.09 COP up to: 3.88.
- Suited for wide range of applications.
- High-efficiency DC twin rotary compressor.
- Extended refrigerant piping capability (300m).
- Operates up to 12 indoor units from a choice of over 80 models.



Hi - Res Image

### Performance & Outdoor Data

Capacity Range		HP	8
Maximum Number of Indoor Units		QTY	12
Cooling Capacity		kW	22.4
Heating Capacity		kW	22.4
Operating Range	Cooling	°C	-5.0 to 46.0
	Heating		-20.0 to 15.0
Cooling	Power Consumption	kW	6.67
	EER/SEER/Energy Efficiency Class (or nsc %)		3.36/8.09/320.6
Heating	Power Consumption	kW	5.20
	COP/SCOP/Energy Efficiency Class (or nsc (A) %)		4.31/4.50/177.0
Fan(s)	Standard Air Flow	l/s	2350
	Standard Air Flow	m <sup>3</sup> /h	8460
Sound	Pressure Level C/H	dB(A)	58/59
	Power Level C/H	dB(A)	75/75
Unit(s)	Height x Width x Depth	mm	1740 x 990 x 390
	Weight	kg	147
Pipe Connections	Refrigerant Base Charge	kg	4.4
	Suction Gas Pipe Flare	inch	3/4
	Liquid Pipe Flare	inch	3/8
	Equivalent Length	m	150
	Real Length	m	120
	Total Pipe Length (Liquid Line Real Length)	m	300
Maximum	Length To First Branch	m	80
	Real Length of Indoor Unit Connecting Piping	m	15
	Height Difference Outdoor Higher Than Indoor Units	m	30
	Height Difference Outdoor Lower Than Indoor Units	m	30
	Height Difference Between Indoor Units	m	15
Electrical	Electrical Characteristic Running Current Cooling/Heating	A	11.1/8.7
	Power Supply Wiring Starting Current	A	Soft Start
	Power Supply	V-ph-Hz	380-415/3/50
	Suggested Fused Supply(s)	A	20

\*All [Accessories](#) / [Controls](#)

### Related items:

- [Full specification](#)
- [BIM files](#)
- [CAD files](#)
- [Refrigerant cycle](#)
- [Dimensional drawing](#)
- [Wiring diagram](#)
- [Noise curve data](#)
- [Installation manual](#)

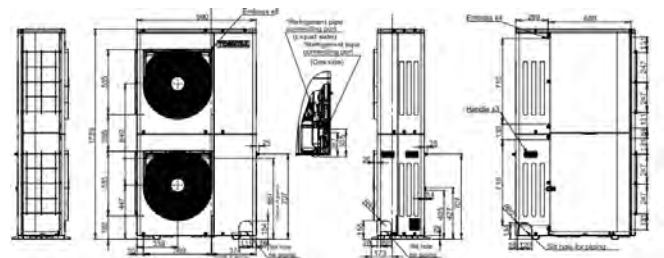

## VRF MINI SMMS<sub>e</sub> R410A: MCY - MHP1006HS8-E

### STAND ALONE - TWIN FAN

- SEER up to: 7.40 COP up to: 4.38.
- Suited for wide range of applications.
- High-efficiency DC twin rotary compressor.
- Extended refrigerant piping capability (300m).
- Operates up to 16 indoor units from a choice of over 80 models.



Hi - Res Image 

### Performance & Outdoor Data

Capacity Range		HP	10
Maximum Number of Indoor Units		QTY	16
Cooling Capacity		kW	28.0
Heating Capacity		kW	28.0
Operating Range	Cooling	°C	-5.0 to 46.0
	Heating		-20.0 to 15.0
Cooling	Power Consumption	kW	9.34
	EER/SEER/Energy Efficiency Class (or nsc %)		3.00/7.40/293.0
Heating	Power Consumption	kW	7.00
	COP/SCOP/Energy Efficiency Class (or nsc (A) %)		4.00/4.38/172.2
Fan(s)	Standard Air Flow	l/s	2450
	Standard Air Flow	m <sup>3</sup> /h	8820
Sound	Pressure Level C/H	dB(A)	59/60
	Power Level C/H	dB(A)	77/77
Unit(s)	Height x Width x Depth	mm	1740 x 990 x 390
	Weight	kg	147
Pipe Connections	Refrigerant Base Charge	kg	4.4
	Suction Gas Pipe Flare	inch	3/4
	Liquid Pipe Flare	inch	3/8
	Equivalent Length	m	150
	Real Length	m	120
	Total Pipe Length (Liquid Line Real Length)	m	300
Maximum	Length To First Branch	m	80
	Real Length of Indoor Unit Connecting Piping	m	15
	Height Difference Outdoor Higher Than Indoor Units	m	30
	Height Difference Outdoor Lower Than Indoor Units	m	30
	Height Difference Between Indoor Units	m	15
	Electrical Characteristic Running Current Cooling/Heating	A	15.3/11.4
Electrical	Power Supply Wiring Starting Current	A	Soft Start
	Power Supply	V-ph-Hz	380-415/3/50
	Suggested Fused Supply(s)	A	25

\*All [Accessories](#) / [Controls](#)

### Related items:

- [Full specification](#)
- [BIM files](#)
- [CAD files](#)
- [Refrigerant cycle](#)
- [Dimensional drawing](#)
- [Wiring diagram](#)
- [Noise curve data](#)
- [Installation manual](#)

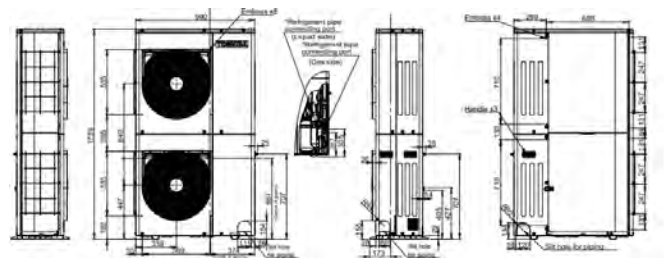



# SMMSu



## VRF SMMSu R410a: MMY - MUP0801HT8P-E

### STAND ALONE

- Single module from 8 to 24HP.
- Operating conditions from -25°C to +52°C.
- Up to 128 indoor units connected per system.
- New A3 twin rotary compressor and a totally redesigned chassis.
- Up to 500m total piping length with 100m from outdoor to the farthest indoor unit.



Hi - Res Image 

Performance & Outdoor Data			
Capacity Range		HP	8
Maximum Number of Indoor Units		QTY	18
Cooling Capacity		kW	22.4
Heating Capacity		kW	22.4
Operating Range	Cooling	°C	-10.0 to 52.0
	Heating		-25.0 to 15.5
Cooling	Power Consumption	kW	5.64
	EER/SEER/Energy Efficiency Class (or nsc %)		3.97/7.44/294.6
Heating	Power Consumption	kW	5.28
	COP/SCOP/Energy Efficiency Class (or nsc(A) %)		4.24/4.50/177.0
Fan(s)	Standard Air Flow H	l/s	2750
	Standard Air Flow H	m <sup>3</sup> /h	9900
	External Static Pressure	Pa	80
Sound	Pressure Level C/H	dB(A)	53/56
	Power Level C/H	dB(A)	75/76
Unit(s)	Height x Width x Depth	mm	1690 x 990 x 780
	Weight	kg	228
Pipe Connections	Refrigerant Base Charge	kg	6
	Suction Gas Pipe Brazing	inch	3/4
	Liquid Pipe Flare	inch	1/2
	Equivalent Length	m	210
	Real Length	m	170
	Total Pipe Length (Liquid Line Real Length)	m	500
	Length To First Branch	m	100
Maximum	Equivalent Length Of Outdoor Unit Connecting Pipe	m	10
	Real Length Of Indoor Unit Connecting Piping	m	30
	Equivalent Length Between Branches	m	50
	Height Difference Outdoor Higher Than Indoor Units	m	70 (110*)
	Height Difference Outdoor Lower Than Indoor Units	m	40 (110*)
	Height Difference Between Indoor Units	m	40
	Height Difference Between Outdoor Units	m	5
Electrical	Voltage Range Minimum/Maximum	V	342/456
	Electrical Characteristic Running Current Cooling/Heating	A	9.15/8.56
	Power Supply Wiring Starting Current	A	Soft Start
	Power Supply	V/ph/Hz	380-415/3/50
	Suggested Fused Supply(s)	A	20

\*All [Accessories](#) / [Controls](#)

Related items:

- [Full specification](#)
- [BIM files](#)
- [CAD files](#)
- [Refrigerant cycle](#)
- [Dimensional drawing](#)
- [Wiring diagram](#)
- [Noise curve data](#)
- [Installation manual](#)

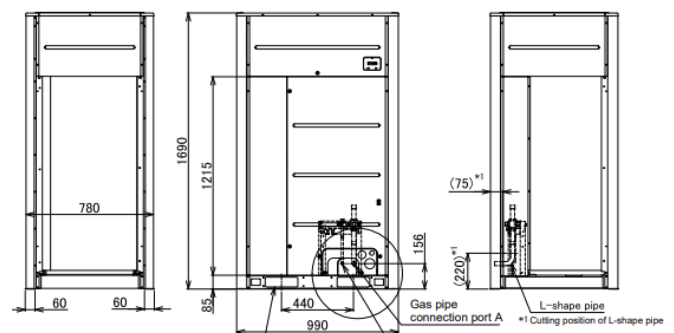

## VRF SMMSu R410a: MMY - MUP1001HT8P-E

### STAND ALONE

- Single module from 8 to 24HP.
- Operating conditions from -25°C to +52°C.
- Up to 128 indoor units connected per system.
- New A3 twin rotary compressor and a totally redesigned chassis.
- Up to 500m total piping length with 100m from outdoor to the farthest indoor unit.



Hi - Res Image

### Performance & Outdoor Data

Capacity Range		HP	10
Maximum Number of Indoor Units		QTY	22
Cooling Capacity		kW	28.0
Heating Capacity		kW	28.0
Operating Range	Cooling	°C	-10.0 to 52.0
	Heating		-25.0 to 15.5
Cooling	Power Consumption	kW	8.36
	EER/SEER/Energy Efficiency Class (or nsc %)		3.35/7.73/306.2
Heating	Power Consumption	kW	7.20
	COP/SCOP/Energy Efficiency Class (or nsc(A) %)		3.89/4.78/188.2
Fan(s)	Standard Air Flow H	l/s	2917
	Standard Air Flow H	m <sup>3</sup> /h	10500
	External Static Pressure	Pa	80
Sound	Pressure Level C/H	dB(A)	55/58
	Power Level C/H	dB(A)	77/77
Unit(s)	Height x Width x Depth	mm	1690 x 990 x 780
	Weight	kg	228
Pipe Connections	Refrigerant Base Charge	kg	6
	Suction Gas Pipe Brazing	inch	7/8
	Liquid Pipe Flare	inch	1/2
	Equivalent Length	m	210
	Real Length	m	170
	Total Pipe Length (Liquid Line Real Length)	m	500
	Length To First Branch	m	100
Maximum	Equivalent Length Of Outdoor Unit Connecting Pipe	m	10
	Real Length Of Indoor Unit Connecting Piping	m	30
	Equivalent Length Between Branches	m	50
	Height Difference Outdoor Higher Than Indoor Units	m	70 (110*)
	Height Difference Outdoor Lower Than Indoor Units	m	40 (110*)
	Height Difference Between Indoor Units	m	40
Electrical	Height Difference Between Outdoor Units	m	5
	Voltage Range Minimum/Maximum	V	342/456
	Electrical Characteristic Running Current Cooling/Heating	A	13.40/11.50
	Power Supply Wiring Starting Current	A	Soft Start
	Power Supply	V/ph/Hz	380-415/3/50
Suggested Fused Supply(s)	A	25	

\*All [Accessories](#) / [Controls](#)

Related items:

- [Full specification](#)
- [BIM files](#)
- [CAD files](#)
- [Refrigerant cycle](#)
- [Dimensional drawing](#)
- [Wiring diagram](#)
- [Noise curve data](#)
- [Installation manual](#)

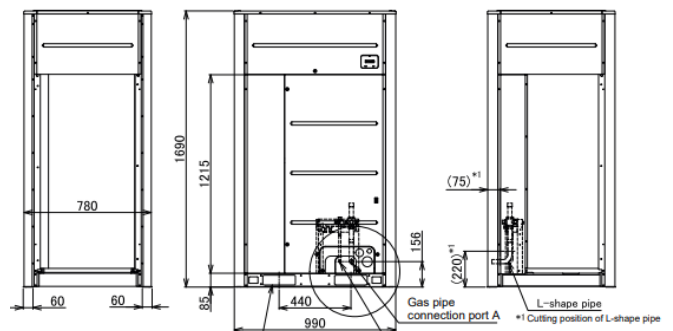

## VRF SMMSu R410a: MMY - MUP1201HT8P-E

### STAND ALONE

- Single module from 8 to 24HP.
- Operating conditions from -25°C to +52°C.
- Up to 128 indoor units connected per system.
- New A3 twin rotary compressor and a totally redesigned chassis.
- Up to 500m total piping length with 100m from outdoor to the farthest indoor unit.



Hi - Res Image

### Performance & Outdoor Data

Capacity Range		HP	12
Maximum Number of Indoor Units		QTY	27
Cooling Capacity		kW	33.5
Heating Capacity		kW	33.5
Operating Range	Cooling	°C	-10.0 to 52.0
	Heating		-25.0 to 15.5
Cooling	Power Consumption	kW	10.34
	EER/SEER/Energy Efficiency Class (or nsc %)		3.24/7.32/289.8
Heating	Power Consumption	kW	7.77
	COP/SCOP/Energy Efficiency Class (or nsc(A) %)		4.31/4.75/187.0
Fan(s)	Standard Air Flow H	l/s	3250
	Standard Air Flow H	m <sup>3</sup> /h	11700
	External Static Pressure	Pa	80
Sound	Pressure Level C/H	dB(A)	58/62
	Power Level C/H	dB(A)	79/81
Unit(s)	Height x Width x Depth	mm	1690 x 990 x 780
	Weight	kg	228
Pipe Connections	Refrigerant Base Charge	kg	6
	Suction Gas Pipe Brazing	inch	1 1/8
	Liquid Pipe Flare	inch	1/2
	Equivalent Length	m	210
	Real Length	m	170
	Total Pipe Length (Liquid Line Real Length)	m	500
	Length To First Branch	m	100
Maximum	Equivalent Length Of Outdoor Unit Connecting Pipe	m	10
	Real Length Of Indoor Unit Connecting Piping	m	30
	Equivalent Length Between Branches	m	50
	Height Difference Outdoor Higher Than Indoor Units	m	70 (110*)
	Height Difference Outdoor Lower Than Indoor Units	m	40 (110*)
	Height Difference Between Indoor Units	m	40
Electrical	Height Difference Between Outdoor Units	m	5
	Voltage Range Minimum/Maximum	V	342/456
	Electrical Characteristic Running Current Cooling/Heating	A	16.00/12.10
	Power Supply Wiring Starting Current	A	Soft Start
	Power Supply	V/ph/Hz	380-415/3/50
Suggested Fused Supply(s)	A	32	

### \*All Accessories / Controls

#### Related items:

- [Full specification](#)
- [BIM files](#)
- [CAD files](#)
- [Refrigerant cycle](#)
- [Dimensional drawing](#)
- [Wiring diagram](#)
- [Noise curve data](#)
- [Installation manual](#)

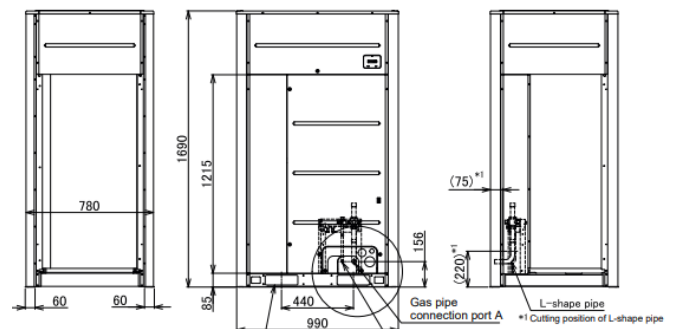

## VRF SMMSu R410a: MMY - MUP1401HT8P-E

### STAND ALONE

- Single module from 8 to 24HP.
- Operating conditions from -25°C to +52°C.
- Up to 128 indoor units connected per system.
- New A3 twin rotary compressor and a totally redesigned chassis.
- Up to 500m total piping length with 100m from outdoor to the farthest indoor unit.



Hi - Res Image

### Performance & Outdoor Data

Capacity Range		HP	14	
Maximum Number of Indoor Units		QTY	31	
Cooling Capacity		kW	40.0	
Heating Capacity		kW	40.0	
Operating Range	Cooling	°C	-10.0 to 52.0	
	Heating		-25.0 to 15.5	
Cooling	Power Consumption	kW	14.55	
	EER/SEER/Energy Efficiency Class (or nsc %)		2.75/7.05/279.0	
Heating	Power Consumption	kW	10.00	
	COP/SCOP/Energy Efficiency Class (or nsc(A) %)		4.00/4.60/181.0	
Fan(s)	Standard Air Flow H	l/s	3300	
	Standard Air Flow H	m <sup>3</sup> /h	11880	
	External Static Pressure	Pa	80	
Sound	Pressure Level C/H	dB(A)	58/62	
	Power Level C/H	dB(A)	79/82	
Unit(s)	Height x Width x Depth	mm	1690 x 990 x 780	
	Weight	kg	228	
Pipe Connections	Refrigerant Base Charge	kg	6	
	Suction Gas Pipe Brazing	inch	1 1/8	
	Liquid Pipe Flare	inch	5/8	
	Equivalent Length	m	210	
	Real Length	m	170	
	Total Pipe Length (Liquid Line Real Length)	m	500	
	Length To First Branch	m	100	
	Equivalent Length Of Outdoor Unit Connecting Pipe	m	10	
	Real Length Of Indoor Unit Connecting Piping	m	30	
	Equivalent Length Between Branches	m	50	
Maximum	Height Difference Outdoor Higher Than Indoor Units	m	70 (110*)	
	Height Difference Outdoor Lower Than Indoor Units	m	40 (110*)	
	Height Difference Between Indoor Units	m	40	
	Height Difference Between Outdoor Units	m	5	
	Electrical	Voltage Range Minimum/Maximum	V	342/456
		Electrical Characteristic Running Current Cooling/Heating	A	22.60/15.50
Power Supply Wiring Starting Current		A	Soft Start	
Power Supply		V/ph/Hz	380-415/3/50	
Suggested Fused Supply(s)		A	40	

\*All [Accessories / Controls](#)

Related items:

- [Full specification](#)
- [BIM files](#)
- [CAD files](#)
- [Refrigerant cycle](#)
- [Dimensional drawing](#)
- [Wiring diagram](#)
- [Noise curve data](#)
- [Installation manual](#)

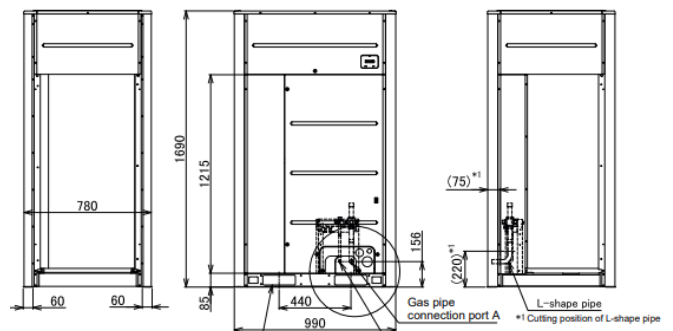



## VRF SMMSu R410a: MMY - MUP1601HT8P-E

### STAND ALONE

- Single module from 8 to 24HP.
- Operating conditions from -25°C to +52°C.
- Up to 128 indoor units connected per system.
- Unique Triple Rotary Compressor and a totally redesigned chassis.
- Up to 500m total piping length with 100m from outdoor to the farthest indoor unit.



Hi - Res Image

Performance & Outdoor Data		
Capacity Range		HP 16
Maximum Number of Indoor Units		QTY 36
Cooling Capacity		kW 45.0
Heating Capacity		kW 45.0
Operating Range	Cooling	°C -10.0 to 52.0
	Heating	
Cooling	Power Consumption	kW 14.06
	EER/SEER/Energy Efficiency Class (or nsc %)	3.20/7.71/305.4
Heating	Power Consumption	kW 11.94
	COP/SCOP/Energy Efficiency Class (or nsc(A) %)	3.77/4.79/188.6
Fan(s)	Standard Air Flow H	l/s 4250
	Standard Air Flow H	m <sup>3</sup> /h 15300
	External Static Pressure	Pa 80
Sound	Pressure Level C/H	dB(A) 60/63
	Power Level C/H	dB(A) 83/86
Unit(s)	Height x Width x Depth	mm 1690 x 1290 x 780
	Weight	kg 312
Pipe Connections	Refrigerant Base Charge	kg 9
	Suction Gas Pipe Brazing	inch 1 1/8
	Liquid Pipe Flare	inch 5/8
	Equivalent Length	m 210
	Real Length	m 170
	Total Pipe Length (Liquid Line Real Length)	m 500
	Length To First Branch	m 100
	Equivalent Length Of Outdoor Unit Connecting Pipe	m 10
Maximum	Real Length Of Indoor Unit Connecting Piping	m 30
	Equivalent Length Between Branches	m 50
	Height Difference Higher Than Indoor Units	m 70 (110*)
	Height Difference Outdoor Lower Than Indoor Units	m 40 (110*)
	Height Difference Between Indoor Units	m 40
	Height Difference Between Outdoor Units	m 5
Electrical	Voltage Range Minimum/Maximum	V 342/456
	Electrical Characteristic Running Current Cooling/Heating	A 21.60/18.30
	Power Supply Wiring Starting Current	A Soft Start
	Power Supply	V/ph/Hz 380-415/3/50
	Suggested Fused Supply(s)	A 40

\*All [Accessories](#) / [Controls](#)

Related items:

- [Full specification](#)
- [BIM files](#)
- [CAD files](#)
- [Refrigerant cycle](#)
- [Dimensional drawing](#)
- [Wiring diagram](#)
- [Noise curve data](#)
- [Installation manual](#)

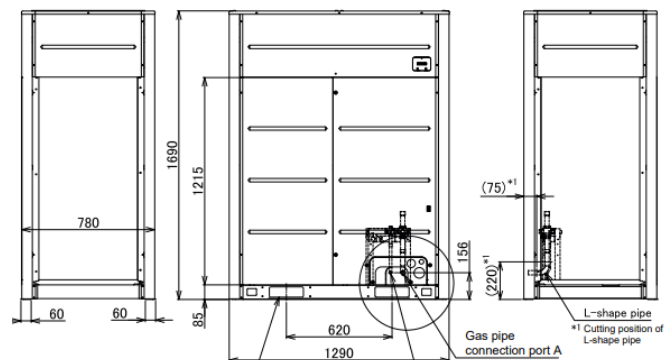

## VRF SMMSu R410a: MMY - MUP1801HT8P-E

### STAND ALONE

- Single module from 8 to 24HP.
- Operating conditions from -25°C to +52°C.
- Up to 128 indoor units connected per system.
- Unique Triple Rotary Compressor and a totally redesigned chassis.
- Up to 500m total piping length with 100m from outdoor to the farthest indoor unit.



Hi - Res Image

### Performance & Outdoor Data

Capacity Range		HP	18	
Maximum Number of Indoor Units		QTY	40	
Cooling Capacity		kW	50.4	
Heating Capacity		kW	50.4	
Operating Range	Cooling	°C	-10.0 to 52.0	
	Heating		-25.0 to 15.5	
Cooling	Power Consumption	kW	15.90	
	EER/SEER/Energy Efficiency Class (or nsc %)		3.17/7.68/304.2	
Heating	Power Consumption	kW	12.54	
	COP/SCOP/Energy Efficiency Class (or nsc(A) %)		4.02/4.75/187.0	
Fan(s)	Standard Air Flow H	l/s	4667	
	Standard Air Flow H	m <sup>3</sup> /h	16800	
	External Static Pressure	Pa	80	
Sound	Pressure Level C/H	dB(A)	61/67	
	Power Level C/H	dB(A)	84/89	
Unit(s)	Height x Width x Depth	mm	1690 x 1290 x 780	
	Weight	kg	312	
Pipe Connections	Refrigerant Base Charge	kg	9	
	Suction Gas Pipe Brazing	inch	1 1/8	
	Liquid Pipe Flare	inch	5/8	
	Equivalent Length	m	210	
	Real Length	m	170	
	Total Pipe Length (Liquid Line Real Length)	m	500	
	Length To First Branch	m	100	
	Equivalent Length Of Outdoor Unit Connecting Pipe	m	10	
	Real Length Of Indoor Unit Connecting Piping	m	30	
	Equivalent Length Between Branches	m	50	
Maximum	Height Difference Outdoor Higher Than Indoor Units	m	70 (110*)	
	Height Difference Outdoor Lower Than Indoor Units	m	40 (110*)	
	Height Difference Between Indoor Units	m	40	
	Height Difference Between Outdoor Units	m	5	
	Electrical	Voltage Range Minimum/Maximum	V	342/456
		Electrical Characteristic Running Current Cooling/Heating	A	24.40/19.30
Power Supply Wiring Starting Current		A	Soft Start	
Power Supply		V/ph/Hz	380-415/3/50	
Suggested Fused Supply(s)		A	40	

### \*All Accessories / Controls

#### Related items:

- [Full specification](#)
- [BIM files](#)
- [CAD files](#)
- [Refrigerant cycle](#)
- [Dimensional drawing](#)
- [Wiring diagram](#)
- [Noise curve data](#)
- [Installation manual](#)

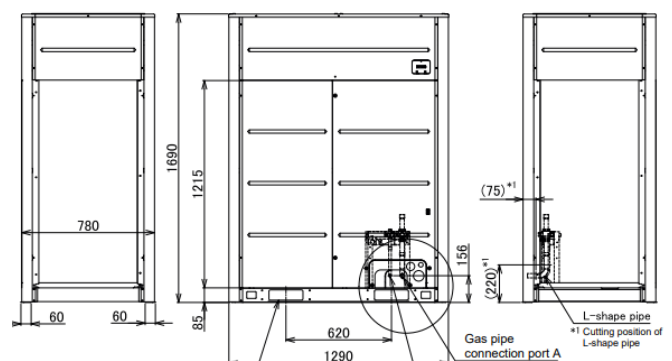

## VRF SMMSu R410a: MMY - MUP2001HT8P-E

### STAND ALONE

- Single module from 8 to 24HP.
- Operating conditions from -25°C to +52°C.
- Up to 128 indoor units connected per system.
- New A3 twin rotary compressor and a totally redesigned chassis.
- Up to 500m total piping length with 100m from outdoor to the farthest indoor unit.



Hi - Res Image

### Performance & Outdoor Data

Capacity Range		HP	20
Maximum Number of Indoor Units		QTY	45
Cooling Capacity		kW	56.0
Heating Capacity		kW	56.0
Operating Range	Cooling	°C	-10.0 to 52.0
	Heating		-25.0 to 15.5
Cooling	Power Consumption	kW	18.01
	EER/SEER/Energy Efficiency Class (or nsc %)		3.11/7.62/301.8
Heating	Power Consumption	kW	14.93
	COP/SCOP/Energy Efficiency Class (or nsc(A) %)		3.75/4.43/174.2
Fan(s)	Standard Air Flow H	l/s	4417
	Standard Air Flow H	m <sup>3</sup> /h	15900
	External Static Pressure	Pa	80
Sound	Pressure Level C/H	dB(A)	63/67
	Power Level C/H	dB(A)	86/90
Unit(s)	Height x Width x Depth	mm	1690 x 1290 x 780
	Weight	kg	334
Pipe Connections	Refrigerant Base Charge	kg	9
	Suction Gas Pipe Brazing	inch	1 1/8
	Liquid Pipe Flare	inch	5/8
	Equivalent Length	m	210
	Real Length	m	170
	Total Pipe Length (Liquid Line Real Length)	m	500
	Length To First Branch	m	100
	Equivalent Length Of Outdoor Unit Connecting Pipe	m	10
Maximum	Real Length Of Indoor Unit Connecting Piping	m	30
	Equivalent Length Between Branches	m	50
	Height Difference Outdoor Higher Than Indoor Units	m	70 (110*)
	Height Difference Outdoor Lower Than Indoor Units	m	40 (110*)
	Height Difference Between Indoor Units	m	40
	Height Difference Between Outdoor Units	m	5
Electrical	Voltage Range Minimum/Maximum	V	342/456
	Electrical Characteristic Running Current Cooling/Heating	A	27.70/22.90
	Power Supply Wiring Starting Current	A	Soft Start
	Power Supply	V/ph/Hz	380-415/3/50
	Suggested Fused Supply(s)	A	40

\*All [Accessories](#) / [Controls](#)

### Related items:

- [Full specification](#)
- [BIM files](#)
- [CAD files](#)
- [Refrigerant cycle](#)
- [Dimensional drawing](#)
- [Wiring diagram](#)
- [Noise curve data](#)
- [Installation manual](#)

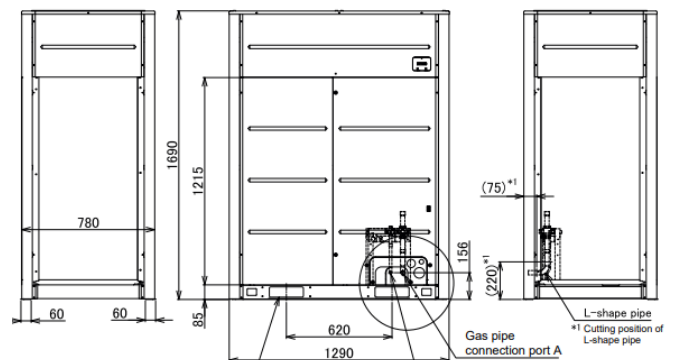

## VRF SMMSu R410a: MMY - MUP2201HT8P-E

### STAND ALONE

- Single module from 8 to 24HP.
- Operating conditions from -25°C to +52°C.
- Up to 128 indoor units connected per system.
- New A3 twin rotary compressor and a totally redesigned chassis.
- Up to 500m total piping length with 100m from outdoor to the farthest indoor unit.



Hi - Res Image

### Performance & Outdoor Data

Capacity Range		HP	22
Maximum Number of Indoor Units		QTY	49
Cooling Capacity		kW	61.5
Heating Capacity		kW	61.5
Operating Range	Cooling	°C	-10.0 to 52.0
	Heating		-25.0 to 15.5
Cooling	Power Consumption	kW	20.43
	EER/SEER/Energy Efficiency Class (or nsc %)		3.01/7.23/286.2
Heating	Power Consumption	kW	16.18
	COP/SCOP/Energy Efficiency Class (or nsc(A) %)		3.80/4.44/174.6
Fan(s)	Standard Air Flow H	l/s	4583
	Standard Air Flow H	m <sup>3</sup> /h	16500
	External Static Pressure	Pa	80
Sound	Pressure Level C/H	dB(A)	63/67
	Power Level C/H	dB(A)	86/90
Unit(s)	Height x Width x Depth	mm	1690 x 1290 x 780
	Weight	kg	356
Pipe Connections	Refrigerant Base Charge	kg	9
	Suction Gas Pipe Brazing	inch	1 1/8
	Liquid Pipe Flare	inch	3/4
	Equivalent Length	m	210
	Real Length	m	170
	Total Pipe Length (Liquid Line Real Length)	m	500
	Length To First Branch	m	100
	Equivalent Length Of Outdoor Unit Connecting Pipe	m	10
Maximum	Real Length Of Indoor Unit Connecting Piping	m	30
	Equivalent Length Between Branches	m	50
	Height Difference Outdoor Higher Than Indoor Units	m	70 (110*)
	Height Difference Outdoor Lower Than Indoor Units	m	40 (110*)
	Height Difference Between Indoor Units	m	40
	Height Difference Between Outdoor Units	m	5
Electrical	Voltage Range Minimum/Maximum	V	342/456
	Electrical Characteristic Running Current Cooling/Heating	A	31.40/24.80
	Power Supply Wiring Starting Current	A	Soft Start
	Power Supply	V/ph/Hz	380-415/3/50
	Suggested Fused Supply(s)	A	50

\*All [Accessories](#) / [Controls](#)

Related items:

- [Full specification](#)
- [BIM files](#)
- [CAD files](#)
- [Refrigerant cycle](#)
- [Dimensional drawing](#)
- [Wiring diagram](#)
- [Noise curve data](#)
- [Installation manual](#)

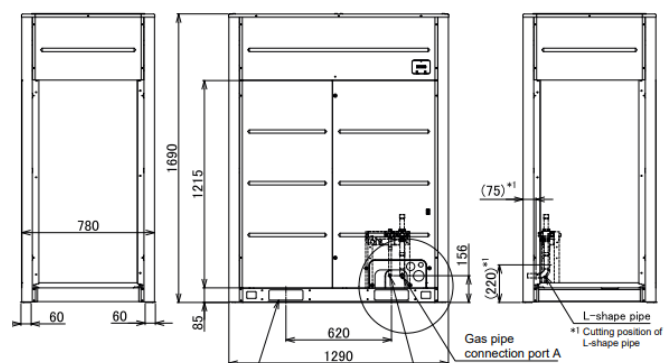

## VRF SMMSu R410a: MMY - MUP2401HT8P-E1

### STAND ALONE

- Single module from 8 to 24HP.
- Operating conditions from -25°C to +52°C.
- Up to 128 indoor units connected per system.
- New A3 twin rotary compressor and a totally redesigned chassis.
- Up to 500m total piping length with 100m from outdoor to the farthest indoor unit.



Hi - Res Image

### Performance & Outdoor Data

Capacity Range		HP	24
Maximum Number of Indoor Units		QTY	54
Cooling Capacity		kW	67.0
Heating Capacity		kW	67.0
Operating Range	Cooling	°C	-10.0 to 52.0
	Heating		-25.0 to 15.5
Cooling	Power Consumption	kW	24.19
	EER/SEER/Energy Efficiency Class (or nsc %)		2.77/6.87/271.8
Heating	Power Consumption	kW	18.98
	COP/SCOP/Energy Efficiency Class (or nsc(A) %)		3.53/4.17/163.8
Fan(s)	Standard Air Flow H	l/s	4583
	Standard Air Flow H	m <sup>3</sup> /h	16500
	External Static Pressure	Pa	80
Sound	Pressure Level C/H	dB(A)	63/67
	Power Level C/H	dB(A)	86/90
Unit(s)	Height x Width x Depth	mm	1690 x 1290 x 780
	Weight	kg	356
Pipe Connections	Refrigerant Base Charge	kg	9
	Suction Gas Pipe Brazing	inch	1 3/8
	Liquid Pipe Flare	inch	3/4
	Equivalent Length	m	210
	Real Length	m	170
	Total Pipe Length (Liquid Line Real Length)	m	500
	Length To First Branch	m	100
Maximum	Equivalent Length Of Outdoor Unit Connecting Pipe	m	10
	Real Length Of Indoor Unit Connecting Piping	m	30
	Equivalent Length Between Branches	m	50
	Height Difference Outdoor Higher Than Indoor Units	m	70 (110*)
	Height Difference Outdoor Lower Than Indoor Units	m	40 (110*)
	Height Difference Between Indoor Units	m	40
Electrical	Height Difference Between Outdoor Units	m	5
	Voltage Range Minimum/Maximum	V	342/456
	Electrical Characteristic Running Current Cooling/Heating	A	37.10/29.10
	Power Supply Wiring Starting Current	A	Soft Start
	Power Supply	V/ph/Hz	380-415/3/50
Suggested Fused Supply(s)	A	63	

\*All [Accessories](#) / [Controls](#)

Related items:

- [Full specification](#)
- [BIM files](#)
- [CAD files](#)
- [Refrigerant cycle](#)
- [Dimensional drawing](#)
- [Wiring diagram](#)
- [Noise curve data](#)
- [Installation manual](#)

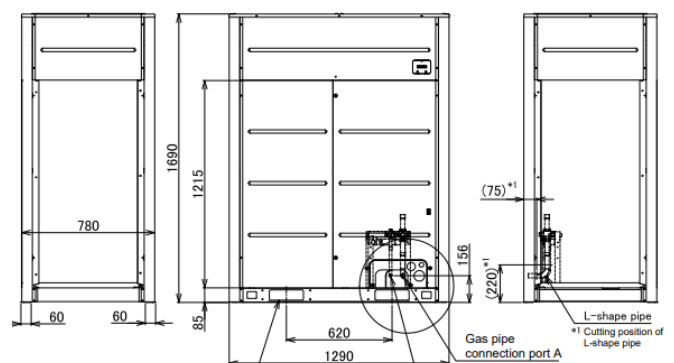

## VRF SMMSu R410a: **UP2611HT8P-E**

### COMBINATIONS

- Operating conditions from -25°C to +52°C.
- Up to 128 indoor units connected per system.
- Possibility to combine up to 5 outdoor units to achieve 120HP.
- Unique Triple Rotary Compressor and a totally redesigned chassis.
- Up to 1,200m total piping length with 250m from outdoor to the farthest indoor unit.



Hi - Res Image

### Performance & Outdoor Data

Model & Combination		UP2611HT8P-E MUP1401HT8P-E MUP1201HT8P-E	
Capacity Range		HP	26
Maximum Number of Indoor Units		QTY	58
Cooling Capacity		kW	73.5
Heating Capacity		kW	73.5
Operating Range	Cooling	°C	-5.0 to 52.0
	Heating		-25.0 to 15.5
Cooling	Power Consumption	kW	24.89
	EER/SEER/Energy Efficiency Class (or nsc %)		2.95/7.17/283.8
Heating	Power Consumption	kW	17.77
	COP/SCOP/Energy Efficiency Class (or nsc(A) %)		4.14/4.67/183.8
Fan(s)	Standard Air Flow H	l/s	6550*
	Standard Air Flow H	m3/h	23580*
	External Static Pressure	Pa	80
Sound	Pressure Level C/H	dB(A)	61.5/65.5
	Power Level C/H	dB(A)	82.5/85
Unit(s)	Height x Width x Depth	mm	1690 x 2000 x 780
	Weight	kg	456*
Pipe Connections	Refrigerant Base Charge	kg	6 x 2
	Suction Gas Pipe Brazing	inch	1 3/8
Maximum	Liquid Pipe Flare	inch	3/4
	Equivalent Length	m	220
	Real Length	m	180
	Total Pipe Length (Liquid Line Real Length)	m	1200
	Length To First Branch	m	100
	Equivalent Length Of Outdoor Unit Connecting Pipe	m	10
	Real Length Of Indoor Unit Connecting Piping	m	30
	Equivalent Length Between Branches	m	50
	Height Difference Outdoor Higher Than Indoor Units	m	70 (110*)
	Height Difference Outdoor Lower Than Indoor Units	m	40 (110*)
Electrical	Height Difference Between Indoor Units	m	40
	Height Difference Between Outdoor Units	m	5
	Voltage Range Minimum/Maximum	V	342/456
	Electrical Characteristic Running Current Cooling/Heating	A	38.60/27.60
	Power Supply Wiring Starting Current	A	Soft Start
Electrical	Power Supply	V/ph/Hz	380-415/3/50
	Suggested Fused Supply(s)	A	40 + 32

\*Combination combined value, see stand alone for individual data

\*All [Accessories](#) / [Controls](#)

Related items:

- [Full specification](#)
- [CAD files](#)
- [Dimensional drawing](#)
- [Connection diagram](#)
- [Noise curve data](#)

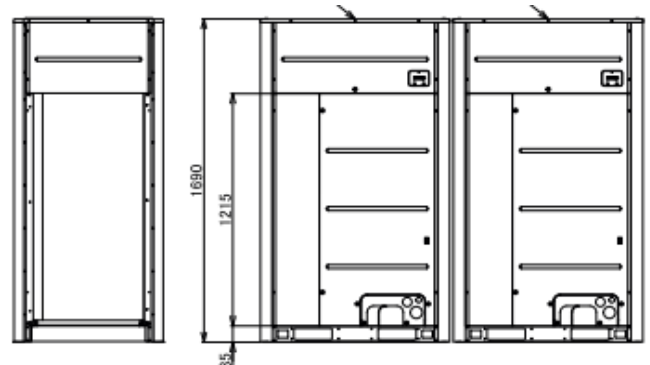

\*For further information see stand alone data

## VRF SMMSu R410a: **UP2811HT8P-E**

### COMBINATIONS

- Operating conditions from -25°C to +52°C.
- Up to 128 indoor units connected per system.
- Possibility to combine up to 5 outdoor units to achieve 120HP.
- Unique Triple Rotary Compressor and a totally redesigned chassis.
- Up to 1,200m total piping length with 250m from outdoor to the farthest indoor unit.



Hi - Res Image

### Performance & Outdoor Data

Model & Combination		UP2811HT8P-E	
		MUP1401HT8P-E x 2	
Capacity Range		HP	28
Maximum Number of Indoor Units		QTY	63
Cooling Capacity		kW	80.0
Heating Capacity		kW	80.0
Operating Range	Cooling	°C	-5.0 to 52.0
	Heating		-25.0 to 15.5
Cooling	Power Consumption	kW	29.10
	EER/SEER/Energy Efficiency Class (or nsc %)		2.75/7.05/279.0
Heating	Power Consumption	kW	20.00
	COP/SCOP/Energy Efficiency Class (or nsc(A) %)		4.00/4.60/181.0
Fan(s)	Standard Air Flow H	l/s	6600*
	Standard Air Flow H	m3/h	23760*
	External Static Pressure	Pa	80
Sound	Pressure Level C/H	dB(A)	61.5/65.5
	Power Level C/H	dB(A)	82.5/85.5
Unit(s)	Height x Width x Depth	mm	1690 x 2000 x 780
	Weight	kg	456*
Pipe Connections	Refrigerant Base Charge	kg	6 x 2
	Suction Gas Pipe Brazing	inch	1 3/8
	Liquid Pipe Flare	inch	3/4
	Equivalent Length	m	220
	Real Length	m	180
	Total Pipe Length (Liquid Line Real Length)	m	1200
	Length To First Branch	m	100
	Equivalent Length Of Outdoor Unit Connecting Pipe	m	10
	Real Length Of Indoor Unit Connecting Piping	m	30
	Equivalent Length Between Branches	m	50
Maximum	Height Difference Outdoor Higher Than Indoor Units	m	70 (110*)
	Height Difference Outdoor Lower Than Indoor Units	m	40 (110*)
	Height Difference Between Indoor Units	m	40
	Height Difference Between Outdoor Units	m	5
	Voltage Range Minimum/Maximum	V	342/456
	Electrical Characteristic Running Current Cooling/Heating	A	45.20/31.00
	Power Supply Wiring Starting Current	A	Soft Start
Electrical	Power Supply	V/ph/Hz	380-415/3/50
	Suggested Fused Supply(s)	A	40 x 2

\*Combination combined value, see stand alone for individual data

\*All [Accessories](#) / [Controls](#)

Related items:

- [Full specification](#)
- [CAD files](#)
- [Dimensional drawing](#)
- [Connection diagram](#)
- [Noise curve data](#)

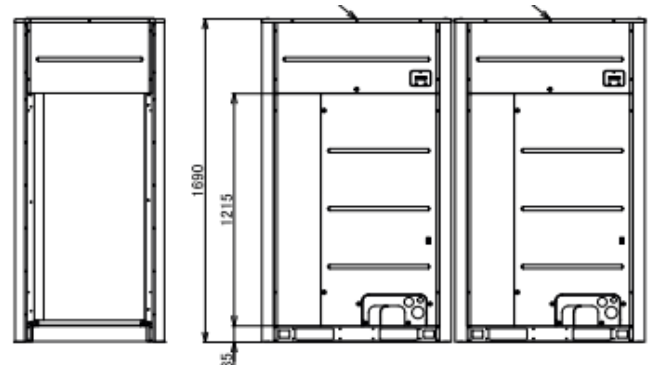

\*For further information see stand alone data

## VRF SMMSu R410a: UP3011HT8P-E

### COMBINATIONS

- Operating conditions from -25°C to +52°C.
- Up to 128 indoor units connected per system.
- Possibility to combine up to 5 outdoor units to achieve 120HP.
- Unique Triple Rotary Compressor and a totally redesigned chassis.
- Up to 1,200m total piping length with 250m from outdoor to the farthest indoor unit.



Hi - Res Image

### Performance & Outdoor Data

Model & Combination		UP3011HT8P-E	
		MUP1401HT8P-E	MUP1201HT8P-E
Capacity Range		HP	30
Maximum Number of Indoor Units		QTY	64
Cooling Capacity		kW	83.9
Heating Capacity		kW	83.9
Operating Range	Cooling	°C	-5.0 to 52.0
	Heating		-25.0 to 15.5
Cooling	Power Consumption	kW	26.24
	EER/SEER/Energy Efficiency Class (or nsc %)		3.20/7.52/297.8
Heating	Power Consumption	kW	20.31
	COP/SCOP/Energy Efficiency Class (or nsc(A) %)		4.13/4.75/187.0
Fan(s)	Standard Air Flow H	l/s	7917*
	Standard Air Flow H	m3/h	28500*
	External Static Pressure	Pa	80
Sound	Pressure Level C/H	dB(A)	63/68.5
	Power Level C/H	dB(A)	85.5/90
Unit(s)	Height x Width x Depth	mm	1690 x 2300 x 780
	Weight	kg	540*
Pipe Connections	Refrigerant Base Charge	kg	9 + 6
	Suction Gas Pipe Brazing	inch	1 3/8
Maximum	Liquid Pipe Flare	inch	3/4
	Equivalent Length	m	220
	Real Length	m	180
	Total Pipe Length (Liquid Line Real Length)	m	1200
	Length To First Branch	m	100
	Equivalent Length Of Outdoor Unit Connecting Pipe	m	10
	Real Length Of Indoor Unit Connecting Piping	m	30
	Equivalent Length Between Branches	m	50
	Height Difference Outdoor Higher Than Indoor Units	m	70 (110*)
	Height Difference Outdoor Lower Than Indoor Units	m	40 (110*)
	Height Difference Between Indoor Units	m	40
	Height Difference Between Outdoor Units	m	5
Electrical	Voltage Range Minimum/Maximum	V	342/456
	Electrical Characteristic Running Current Cooling/Heating	A	40.40/31.40
	Power Supply Wiring Starting Current	A	Soft Start
	Power Supply	V/ph/Hz	380-415/3/50
	Suggested Fused Supply(s)	A	40 + 32

\*Combination combined value, see stand alone for individual data

\*All [Accessories](#) / [Controls](#)

Related items:

- [Full specification](#)
- [CAD files](#)
- [Dimensional drawing](#)
- [Connection diagram](#)
- [Noise curve data](#)

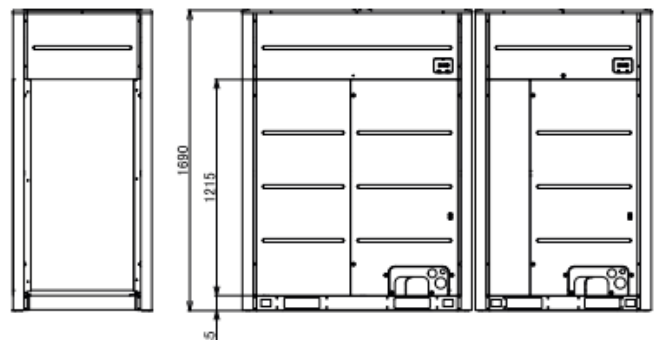

\*For further information see stand alone data



## VRF SMMSu R410a: UP3211HT8P-E

### COMBINATIONS

- Operating conditions from -25°C to +52°C.
- Up to 128 indoor units connected per system.
- Possibility to combine up to 5 outdoor units to achieve 120HP.
- Unique Triple Rotary Compressor and a totally redesigned chassis.
- Up to 1,200m total piping length with 250m from outdoor to the farthest indoor unit.



Hi - Res Image

### Performance & Outdoor Data

Model & Combination		UP3211HT8P-E MUP2001HT8P-E MUP1201HT8P-E	
Capacity Range		HP	32
Maximum Number of Indoor Units		QTY	65
Cooling Capacity		kW	89.5
Heating Capacity		kW	89.5
Operating Range	Cooling	°C	-5.0 to 52.0
	Heating		-25.0 to 15.5
Cooling	Power Consumption	kW	28.35
	EER/SEER/Energy Efficiency Class (or nsc %)		3.16/7.50/297.0
Heating	Power Consumption	kW	22.70
	COP/SCOP/Energy Efficiency Class (or nsc(A) %)		3.94/4.55/179.0
Fan(s)	Standard Air Flow H	l/s	7667*
	Standard Air Flow H	m <sup>3</sup> /h	27600*
Sound	External Static Pressure	Pa	80
	Pressure Level C/H	dB(A)	64.5/68.5
	Power Level C/H	dB(A)	87/91
Unit(s)	Height x Width x Depth	mm	1690 x 2300 x 780
	Weight	kg	562*
Pipe Connections	Refrigerant Base Charge	kg	9 + 6
	Suction Gas Pipe Brazing	inch	1 3/8
Maximum	Liquid Pipe Flare	inch	3/4
	Equivalent Length	m	220
	Real Length	m	180
	Total Pipe Length (Liquid Line Real Length)	m	1200
	Length To First Branch	m	100
	Equivalent Length Of Outdoor Unit Connecting Pipe	m	10
	Real Length Of Indoor Unit Connecting Piping	m	30
	Equivalent Length Between Branches	m	50
	Height Difference Outdoor Higher Than Indoor Units	m	70 (110*)
	Height Difference Outdoor Lower Than Indoor Units	m	40 (110*)
Electrical	Height Difference Between Indoor Units	m	40
	Height Difference Between Outdoor Units	m	5
	Voltage Range Minimum/Maximum	V	342/456
	Electrical Characteristic Running Current Cooling/Heating	A	43.70/35.00
	Power Supply Wiring Starting Current	A	Soft Start
Electrical	Power Supply	V/ph/Hz	380-415/3/50
	Suggested Fused Supply(s)	A	40 + 32

\*Combination combined value, see stand alone for individual data

\*All [Accessories](#) / [Controls](#)

Related items:

- [Full specification](#)
- [CAD files](#)
- [Dimensional drawing](#)
- [Connection diagram](#)
- [Noise curve data](#)

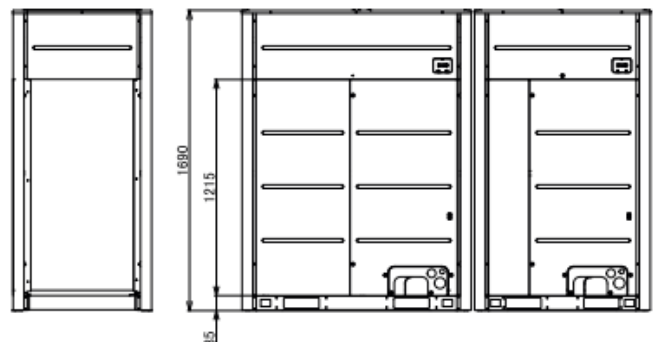

\*For further information see stand alone data

## VRF SMMSu R410a: UP3411HT8P-E

### COMBINATIONS

- Operating conditions from -25°C to +52°C.
- Up to 128 indoor units connected per system.
- Possibility to combine up to 5 outdoor units to achieve 120HP.
- Unique Triple Rotary Compressor and a totally redesigned chassis.
- Up to 1,200m total piping length with 250m from outdoor to the farthest indoor unit.



Hi - Res Image

### Performance & Outdoor Data

Model & Combination		UP3411HT8P-E	
		MUP2001HT8P-E	
		MUP1401HT8P-E	
Capacity Range		HP	34
Maximum Number of Indoor Units		QTY	66
Cooling Capacity		kW	96.0
Heating Capacity		kW	96.0
Operating Range	Cooling	°C	-5.0 to 52.0
	Heating		-25.0 to 15.5
Cooling	Power Consumption	kW	32.56
	EER/SEER/Energy Efficiency Class (or nsc %)		2.95/7.38/292.2
Heating	Power Consumption	kW	24.93
	COP/SCOP/Energy Efficiency Class (or nsc(A) %)		3.85/4.50/177.0
Fan(s)	Standard Air Flow H	l/s	7717*
	Standard Air Flow H	m3/h	27780*
	External Static Pressure	Pa	80
Sound	Pressure Level C/H	dB(A)	64.5/68.5
	Power Level C/H	dB(A)	87/91
Unit(s)	Height x Width x Depth	mm	1690 x 2300 x 780
	Weight	kg	562
Pipe Connections	Refrigerant Base Charge	kg	9 + 6
	Suction Gas Pipe Brazing	inch	1 3/8
Maximum	Liquid Pipe Flare	inch	3/4
	Equivalent Length	m	220
	Real Length	m	180
	Total Pipe Length (Liquid Line Real Length)	m	1200
	Length To First Branch	m	100
	Equivalent Length Of Outdoor Unit Connecting Pipe	m	10
	Real Length Of Indoor Unit Connecting Piping	m	30
	Equivalent Length Between Branches	m	50
	Height Difference Outdoor Higher Than Indoor Units	m	70 (110*)
	Height Difference Outdoor Lower Than Indoor Units	m	40 (110*)
	Height Difference Between Indoor Units	m	40
	Height Difference Between Outdoor Units	m	5
Electrical	Voltage Range Minimum/Maximum	V	342/456
	Electrical Characteristic Running Current Cooling/Heating	A	50.30/38.40
	Power Supply Wiring Starting Current	A	Soft Start
	Power Supply	V/ph/Hz	380-415/3/50
	Suggested Fused Supply(s)	A	40 x 2

\*Combination combined value, see stand alone for individual data

\*All [Accessories](#) / [Controls](#)

Related items:

- [Full specification](#)
- [CAD files](#)
- [Dimensional drawing](#)
- [Connection diagram](#)
- [Noise curve data](#)

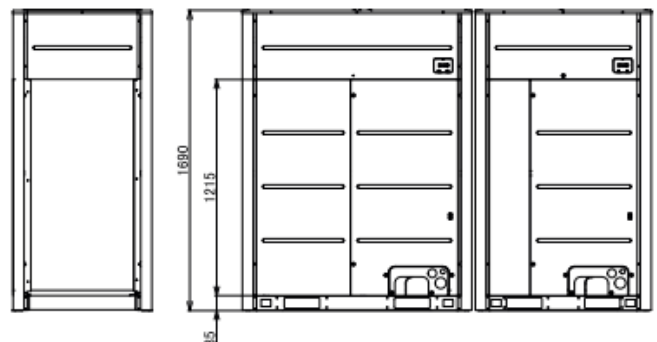

\*For further information see stand alone data

## VRF SMMSu R410a: UP3611HT8P-E

### COMBINATIONS

- Operating conditions from -25°C to +52°C.
- Up to 128 indoor units connected per system.
- Possibility to combine up to 5 outdoor units to achieve 120HP.
- Unique Triple Rotary Compressor and a totally redesigned chassis.
- Up to 1,200m total piping length with 250m from outdoor to the farthest indoor unit.



Hi - Res Image

### Performance & Outdoor Data

Model & Combination		UP3611HT8P-E MUP2401HT8P-E MUP1201HT8P-E	
Capacity Range		HP	36
Maximum Number of Indoor Units		QTY	67
Cooling Capacity		kW	100.5
Heating Capacity		kW	100.5
Operating Range	Cooling	°C	-5.0 to 52.0
	Heating		-25.0 to 15.5
Cooling	Power Consumption	kW	34.53
	EER/SEER/Energy Efficiency Class (or nsc %)		2.91/7.01/277.4
Heating	Power Consumption	kW	26.75
	COP/SCOP/Energy Efficiency Class (or nsc(A) %)		3.76/4.38/172.2
Fan(s)	Standard Air Flow H	l/s	7833*
	Standard Air Flow H	m <sup>3</sup> /h	28200*
	External Static Pressure	Pa	80
Sound	Pressure Level C/H	dB(A)	64.5/68.5
	Power Level C/H	dB(A)	87/91
Unit(s)	Height x Width x Depth	mm	1690 x 2300 x 780
	Weight	kg	584
Pipe Connections	Refrigerant Base Charge	kg	9 + 6
	Suction Gas Pipe Brazing	inch	1 5/8
	Liquid Pipe Flare	inch	7/8
Maximum	Equivalent Length	m	220
	Real Length	m	180
	Total Pipe Length (Liquid Line Real Length)	m	1200
	Length To First Branch	m	100
	Equivalent Length Of Outdoor Unit Connecting Pipe	m	10
	Real Length Of Indoor Unit Connecting Piping	m	30
	Equivalent Length Between Branches	m	50
	Height Difference Outdoor Higher Than Indoor Units	m	70 (110*)
	Height Difference Outdoor Lower Than Indoor Units	m	40 (110*)
	Height Difference Between Indoor Units	m	40
	Height Difference Between Outdoor Units	m	5
	Electrical	Voltage Range Minimum/Maximum	V
Electrical Characteristic Running Current Cooling/Heating		A	53.10/41.20
Power Supply Wiring Starting Current		A	Soft Start
Power Supply		V/ph/Hz	380-415/3/50
	Suggested Fused Supply(s)	A	63 + 32

\*Combination combined value, see stand alone for individual data

\*All [Accessories](#) / [Controls](#)

Related items:

- [Full specification](#)
- [CAD files](#)
- [Dimensional drawing](#)
- [Connection diagram](#)
- [Noise curve data](#)

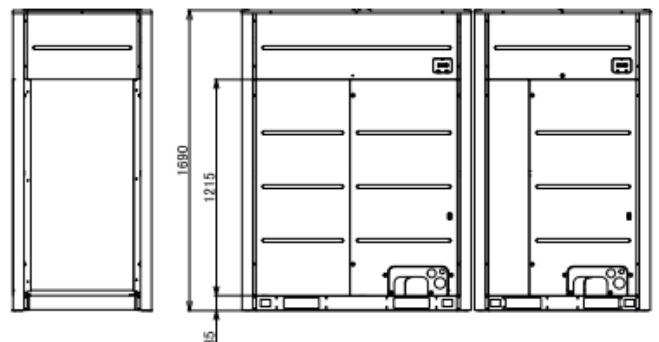

\*For further information see stand alone data

## VRF SMMSu R410a: **UP3811HT8P-E**

### COMBINATIONS

- Operating conditions from -25°C to +52°C.
- Up to 128 indoor units connected per system.
- Possibility to combine up to 5 outdoor units to achieve 120HP.
- Unique Triple Rotary Compressor and a totally redesigned chassis.
- Up to 1,200m total piping length with 250m from outdoor to the farthest indoor unit.



Hi - Res Image

### Performance & Outdoor Data

Model & Combination		UP3811HT8P-E MUP2401HT8P-E MUP1401HT8P-E	
Capacity Range		HP	38
Maximum Number of Indoor Units		QTY	68
Cooling Capacity		kW	107.0
Heating Capacity		kW	107.0
Operating Range	Cooling	°C	-5.0 to 52.0
	Heating		-25.0 to 15.5
Cooling	Power Consumption	kW	38.74
	EER/SEER/Energy Efficiency Class (or nsc %)		2.76/6.93/274.2
Heating	Power Consumption	kW	28.98
	COP/SCOP/Energy Efficiency Class (or nsc(A) %)		3.69/4.33/170.2
Fan(s)	Standard Air Flow H	l/s	7883*
	Standard Air Flow H	m <sup>3</sup> /h	28380*
	External Static Pressure	Pa	80
Sound	Pressure Level C/H	dB(A)	64.5/68.5
	Power Level C/H	dB(A)	87/91
Unit(s)	Height x Width x Depth	mm	1690 x 2300 x 780
	Weight	kg	584*
Pipe Connections	Refrigerant Base Charge	kg	9 + 6
	Suction Gas Pipe Brazing	inch	1 5/8
	Liquid Pipe Flare	inch	7/8
	Equivalent Length	m	220
	Real Length	m	180
	Total Pipe Length (Liquid Line Real Length)	m	1200
	Length To First Branch	m	100
	Equivalent Length Of Outdoor Unit Connecting Pipe	m	10
	Real Length Of Indoor Unit Connecting Piping	m	30
	Equivalent Length Between Branches	m	50
Maximum	Height Difference Outdoor Higher Than Indoor Units	m	70 (110*)
	Height Difference Outdoor Lower Than Indoor Units	m	40 (110*)
	Height Difference Between Indoor Units	m	40
	Height Difference Between Outdoor Units	m	5
	Electrical	Voltage Range Minimum/Maximum	V
	Electrical Characteristic Running Current Cooling/Heating	A	59.70/44.60
	Power Supply Wiring Starting Current	A	Soft Start
	Power Supply	V/ph/Hz	380-415/3/50
	Suggested Fused Supply(s)	A	63 + 40

\*Combination combined value, see stand alone for individual data

\*All [Accessories](#) / [Controls](#)

Related items:

- [Full specification](#)
- [CAD files](#)
- [Dimensional drawing](#)
- [Connection diagram](#)
- [Noise curve data](#)

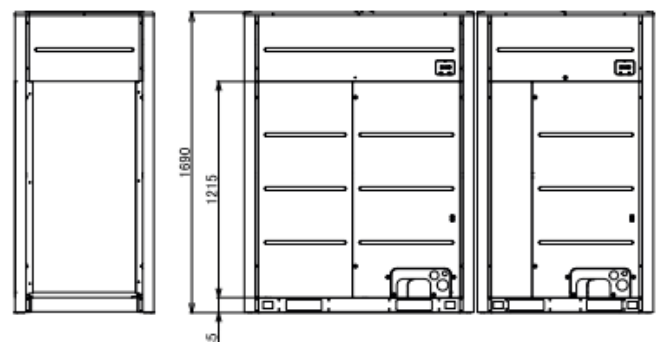

\*For further information see stand alone data

## VRF SMMSu R410a: UP4011HT8P-E

### COMBINATIONS

- Operating conditions from -25°C to +52°C.
- Up to 128 indoor units connected per system.
- Possibility to combine up to 5 outdoor units to achieve 120HP.
- Unique Triple Rotary Compressor and a totally redesigned chassis.
- Up to 1,200m total piping length with 250m from outdoor to the farthest indoor unit.



Hi - Res Image

### Performance & Outdoor Data

Model & Combination		UP4011HT8P-E MUP2001HT8P-E x 2		
Capacity Range		HP	40	
Maximum Number of Indoor Units		QTY	69	
Cooling Capacity		kW	112.0	
Heating Capacity		kW	112.0	
Operating Range	Cooling	°C	-5.0 to 52.0	
	Heating		-25.0 to 15.5	
Cooling	Power Consumption	kW	36.02	
	EER/SEER/Energy Efficiency Class (or nsc %)		3.11/7.62/301.8	
Heating	Power Consumption	kW	29.86	
	COP/SCOP/Energy Efficiency Class (or nsc(A) %)		3.75/4.43/174.2	
Fan(s)	Standard Air Flow H	l/s	8834*	
	Standard Air Flow H	m3/h	31800*	
	External Static Pressure	Pa	80	
Sound	Pressure Level C/H	dB(A)	66.5/70.5	
	Power Level C/H	dB(A)	89.5/93.5	
Unit(s)	Height x Width x Depth	mm	1690 x 2600 x 780	
	Weight	kg	668	
	Refrigerant Base Charge	kg	9 x 2	
Pipe Connections	Suction Gas Pipe Brazing	inch	1 5/8	
	Liquid Pipe Flare	inch	7/8	
	Equivalent Length	m	220	
Maximum	Real Length	m	180	
	Total Pipe Length (Liquid Line Real Length)	m	1200	
	Length To First Branch	m	100	
	Equivalent Length Of Outdoor Unit Connecting Pipe	m	10	
	Real Length Of Indoor Unit Connecting Piping	m	30	
	Equivalent Length Between Branches	m	50	
	Height Difference Outdoor Higher Than Indoor Units	m	70 (110*)	
	Height Difference Outdoor Lower Than Indoor Units	m	40 (110*)	
	Height Difference Between Indoor Units	m	40	
	Height Difference Between Outdoor Units	m	5	
	Electrical	Voltage Range Minimum/Maximum	V	342/456
		Electrical Characteristic Running Current Cooling/Heating	A	55.40/45.80
Power Supply Wiring Starting Current		A	Soft Start	
Power Supply		V/ph/Hz	380-415/3/50	
Suggested Fused Supply(s)		A	40 x 2	

\*Combination combined value, see stand alone for individual data

\*All [Accessories](#) / [Controls](#)

Related items:

- [Full specification](#)
- [CAD files](#)
- [Dimensional drawing](#)
- [Connection diagram](#)
- [Noise curve data](#)

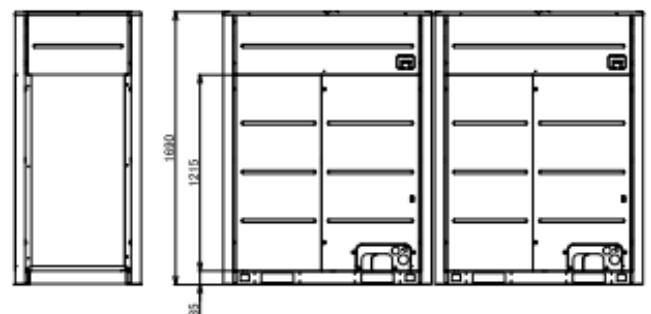

\*For further information see stand alone data

## VRF SMMSu R410a: UP4211HT8P-E

### COMBINATIONS

- Operating conditions from -25°C to +52°C.
- Up to 128 indoor units connected per system.
- Possibility to combine up to 5 outdoor units to achieve 120HP.
- Unique Triple Rotary Compressor and a totally redesigned chassis.
- Up to 1,200m total piping length with 250m from outdoor to the farthest indoor unit.



Hi - Res Image

### Performance & Outdoor Data

Model & Combination		UP4211HT8P-E MUP2401HT8P-E MUP1801HT8P-E	
Capacity Range		HP	42
Maximum Number of Indoor Units		QTY	70
Cooling Capacity		kW	117.4
Heating Capacity		kW	117.4
Operating Range	Cooling	°C	-5.0 to 52.0
	Heating		-25.0 to 15.5
Cooling	Power Consumption	kW	40.09
	EER/SEER/Energy Efficiency Class (or nsc %)		2.93/7.22/285.8
Heating	Power Consumption	kW	31.52
	COP/SCOP/Energy Efficiency Class (or nsc(A) %)		3.72/4.43/174.2
Fan(s)	Standard Air Flow H	l/s	9250*
	Standard Air Flow H	m <sup>3</sup> /h	33300*
	External Static Pressure	Pa	80
Sound	Pressure Level C/H	dB(A)	65.5/70.5
	Power Level C/H	dB(A)	88.5/93
Unit(s)	Height x Width x Depth	mm	1690 x 2600 x 780
	Weight	kg	668
Pipe Connections	Refrigerant Base Charge	kg	9 x 2
	Suction Gas Pipe Brazing	inch	1 5/8
Maximum	Liquid Pipe Flare	inch	7/8
	Equivalent Length	m	220
	Real Length	m	180
	Total Pipe Length (Liquid Line Real Length)	m	1200
	Length To First Branch	m	100
	Equivalent Length Of Outdoor Unit Connecting Pipe	m	10
	Real Length Of Indoor Unit Connecting Piping	m	30
	Equivalent Length Between Branches	m	50
	Height Difference Outdoor Higher Than Indoor Units	m	70 (110*)
	Height Difference Outdoor Lower Than Indoor Units	m	40 (110*)
	Height Difference Between Indoor Units	m	40
	Height Difference Between Outdoor Units	m	5
Electrical	Voltage Range Minimum/Maximum	V	342/456
	Electrical Characteristic Running Current Cooling/Heating	A	61.50/48.40
	Power Supply Wiring Starting Current	A	Soft Start
	Power Supply	V/ph/Hz	380-415/3/50
	Suggested Fused Supply(s)	A	63 + 40

\*Combination combined value, see stand alone for individual data

\*All [Accessories](#) / [Controls](#)

Related items:

- [Full specification](#)
- [CAD files](#)
- [Dimensional drawing](#)
- [Connection diagram](#)
- [Noise curve data](#)

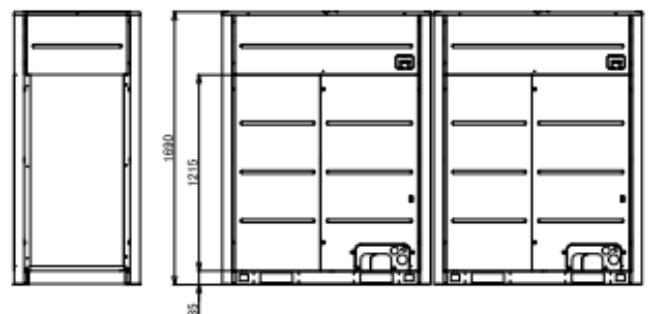

\*For further information see stand alone data

## VRF SMMSu R410a: UP4411HT8P-E

### COMBINATIONS

- Operating conditions from -25°C to +52°C.
- Up to 128 indoor units connected per system.
- Possibility to combine up to 5 outdoor units to achieve 120HP.
- Unique Triple Rotary Compressor and a totally redesigned chassis.
- Up to 1,200m total piping length with 250m from outdoor to the farthest indoor unit.



Hi - Res Image

### Performance & Outdoor Data

Model & Combination		UP4411HT8P-E MUP2401HT8P-E MUP2001HT8P-E	
Capacity Range		HP	44
Maximum Number of Indoor Units		QTY	71
Cooling Capacity		kW	123.0
Heating Capacity		kW	123.0
Operating Range	Cooling	°C	-5.0 to 52.0
	Heating		-25.0 to 15.5
Cooling	Power Consumption	kW	42.20
	EER/SEER/Energy Efficiency Class (or nsc %)		2.91/7.21/285.4
Heating	Power Consumption	kW	33.91
	COP/SCOP/Energy Efficiency Class (or nsc(A) %)		3.63/4.30/169.0
Fan(s)	Standard Air Flow H	l/s	9000*
	Standard Air Flow H	m <sup>3</sup> /h	32400*
	External Static Pressure	Pa	80
Sound	Pressure Level C/H	dB(A)	66.5/70.5
	Power Level C/H	dB(A)	89.5/93.5
Unit(s)	Height x Width x Depth	mm	1690 x 2600 x 780
	Weight	kg	690
	Refrigerant Base Charge	kg	9 x2
Pipe Connections	Suction Gas Pipe Brazing	inch	1 5/8
	Liquid Pipe Flare	inch	7/8
Maximum	Equivalent Length	m	220
	Real Length	m	180
	Total Pipe Length (Liquid Line Real Length)	m	1200
	Length To First Branch	m	100
	Equivalent Length Of Outdoor Unit Connecting Pipe	m	10
	Real Length Of Indoor Unit Connecting Piping	m	30
	Equivalent Length Between Branches	m	50
	Height Difference Outdoor Higher Than Indoor Units	m	70 (110*)
	Height Difference Outdoor Lower Than Indoor Units	m	40 (110*)
	Height Difference Between Indoor Units	m	40
	Height Difference Between Outdoor Units	m	5
	Electrical	Voltage Range Minimum/Maximum	V
Electrical Characteristic Running Current Cooling/Heating		A	64.80/52.00
Power Supply Wiring Starting Current		A	Soft Start
Power Supply		V/ph/Hz	380-415/3/50
	Suggested Fused Supply(s)	A	63 + 40

\*Combination combined value, see stand alone for individual data

\*All [Accessories](#) / [Controls](#)

Related items:

- [Full specification](#)
- [CAD files](#)
- [Dimensional drawing](#)
- [Connection diagram](#)
- [Noise curve data](#)

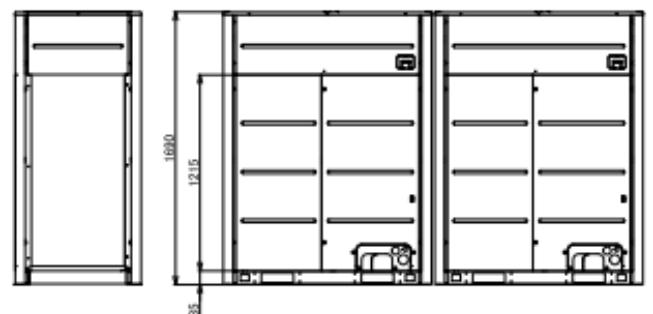

\*For further information see stand alone data

## VRF SMMSu R410a: **UP4611HT8P-E**

### COMBINATIONS

- Operating conditions from -25°C to +52°C.
- Up to 128 indoor units connected per system.
- Possibility to combine up to 5 outdoor units to achieve 120HP.
- Unique Triple Rotary Compressor and a totally redesigned chassis.
- Up to 1,200m total piping length with 250m from outdoor to the farthest indoor unit.



Hi - Res Image

### Performance & Outdoor Data

Model & Combination		UP4611HT8P-E MUP2401HT8P-E MUP2201HT8P-E	
Capacity Range		HP	46
Maximum Number of Indoor Units		QTY	72
Cooling Capacity		kW	128.5
Heating Capacity		kW	128.5
Operating Range	Cooling	°C	-5.0 to 52.0
	Heating		-25.0 to 15.5
Cooling	Power Consumption	kW	44.62
	EER/SEER/Energy Efficiency Class (or nsc %)		2.88/7.04/278.6
Heating	Power Consumption	kW	35.16
	COP/SCOP/Energy Efficiency Class (or nsc(A) %)		3.65/4.31/169.4
Fan(s)	Standard Air Flow H	l/s	9166*
	Standard Air Flow H	m3/h	33000*
Sound	External Static Pressure	Pa	80
	Pressure Level C/H	dB(A)	66.5/70.5
	Power Level C/H	dB(A)	89.5/93.5
Unit(s)	Height x Width x Depth	mm	1690 x 2600 x 780
	Weight	kg	712
Pipe Connections	Refrigerant Base Charge	kg	9 x 2
	Suction Gas Pipe Brazing	inch	1 5/8
	Liquid Pipe Flare	inch	7/8
Maximum	Equivalent Length	m	220
	Real Length	m	180
	Total Pipe Length (Liquid Line Real Length)	m	1200
	Length To First Branch	m	100
	Equivalent Length Of Outdoor Unit Connecting Pipe	m	10
	Real Length Of Indoor Unit Connecting Piping	m	30
	Equivalent Length Between Branches	m	50
	Height Difference Outdoor Higher Than Indoor Units	m	70 (110*)
	Height Difference Outdoor Lower Than Indoor Units	m	40 (110*)
	Height Difference Between Indoor Units	m	40
	Height Difference Between Outdoor Units	m	5
Electrical	Voltage Range Minimum/Maximum	V	342/456
	Electrical Characteristic Running Current Cooling/Heating	A	68.50/53.90
	Power Supply Wiring Starting Current	A	Soft Start
	Power Supply	V/ph/Hz	380-415/3/50
	Suggested Fused Supply(s)	A	63 + 50

\*Combination combined value, see stand alone for individual data

\*All [Accessories](#) / [Controls](#)

Related items:

- [Full specification](#)
- [CAD files](#)
- [Dimensional drawing](#)
- [Connection diagram](#)
- [Noise curve data](#)

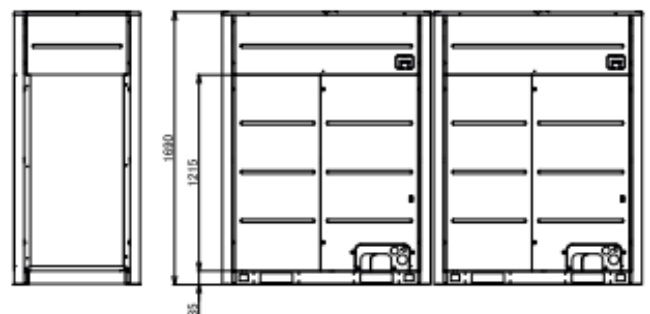

\*For further information see stand alone data



## VRF SMMSu R410a: **UP4811HT8P-E**

### COMBINATIONS

- Operating conditions from -25°C to +52°C.
- Up to 128 indoor units connected per system.
- Possibility to combine up to 5 outdoor units to achieve 120HP.
- Unique Triple Rotary Compressor and a totally redesigned chassis.
- Up to 1,200m total piping length with 250m from outdoor to the farthest indoor unit.



Hi - Res Image

### Performance & Outdoor Data

Model & Combination		UP4811HT8P-E MUP2401HT8P-E x 2	
Capacity Range		HP	48
Maximum Number of Indoor Units		QTY	73
Cooling Capacity		kW	134.0
Heating Capacity		kW	134.0
Operating Range	Cooling	°C	-5.0 to 52.0
	Heating		-25.0 to 15.5
Cooling	Power Consumption	kW	48.38
	EER/SEER/Energy Efficiency Class (or nsc %)		2.77/6.87/271.8
Heating	Power Consumption	kW	37.96
	COP/SCOP/Energy Efficiency Class (or nsc(A) %)		3.53/4.17/163.8
Fan(s)	Standard Air Flow H	l/s	9166*
	Standard Air Flow H	m <sup>3</sup> /h	33000*
	External Static Pressure	Pa	80
Sound	Pressure Level C/H	dB(A)	66.5/70.5
	Power Level C/H	dB(A)	89.5/93.5
Unit(s)	Height x Width x Depth	mm	1690 x 2600 x 780
	Weight	kg	712
Pipe Connections	Refrigerant Base Charge	kg	9 x2
	Suction Gas Pipe Brazing	inch	1 5/8
Maximum	Liquid Pipe Flare	inch	7/8
	Equivalent Length	m	220
	Real Length	m	180
	Total Pipe Length (Liquid Line Real Length)	m	1200
	Length To First Branch	m	100
	Equivalent Length Of Outdoor Unit Connecting Pipe	m	10
	Real Length Of Indoor Unit Connecting Piping	m	30
	Equivalent Length Between Branches	m	50
	Height Difference Outdoor Higher Than Indoor Units	m	70 (110*)
	Height Difference Outdoor Lower Than Indoor Units	m	40 (110*)
Electrical	Height Difference Between Indoor Units	m	40
	Height Difference Between Outdoor Units	m	5
	Voltage Range Minimum/Maximum	V	342/456
	Electrical Characteristic Running Current Cooling/Heating	A	74.20/58.20
	Power Supply Wiring Starting Current	A	Soft Start
Electrical	Power Supply	V/ph/Hz	380-415/3/50
	Suggested Fused Supply(s)	A	63 x2

\*Combination combined value, see stand alone for individual data

\*All [Accessories](#) / [Controls](#)

Related items:

- [Full specification](#)
- [CAD files](#)
- [Dimensional drawing](#)
- [Connection diagram](#)
- [Noise curve data](#)

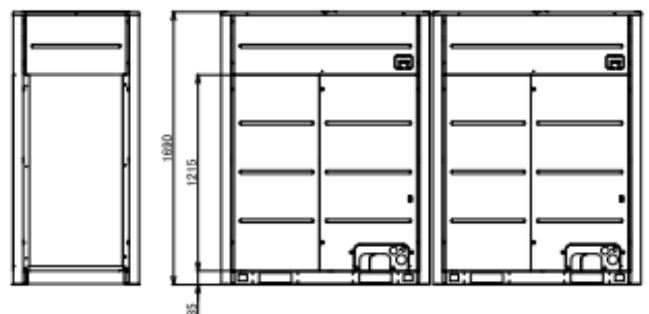

\*For further information see stand alone data

## VRF SMMSu R410a: **UP5011HT8P-E**

### COMBINATIONS

- Operating conditions from -25°C to +52°C.
- Up to 128 indoor units connected per system.
- Possibility to combine up to 5 outdoor units to achieve 120HP.
- Unique Triple Rotary Compressor and a totally redesigned chassis.
- Up to 1,200m total piping length with 250m from outdoor to the farthest indoor unit.



Hi - Res Image

### Performance & Outdoor Data

Model & Combination		UP5011HT8P-E MUP2401HT8P-E MUP1401HT8P-E MUP1201HT8P-E	
Capacity Range		HP	50
Maximum Number of Indoor Units		QTY	74
Cooling Capacity		kW	140.5
Heating Capacity		kW	140.5
Operating Range	Cooling	°C	-5.0 to 52.0
	Heating		-25.0 to 15.5
Cooling	Power Consumption	kW	49.08
	EER/SEER/Energy Efficiency Class (or nsc %)		2.86/7.02/277.8
Heating	Power Consumption	kW	36.75
	COP/SCOP/Energy Efficiency Class (or nsc(A) %)		3.82/4.44/174.6
Fan(s)	Standard Air Flow H	l/s	11133*
	Standard Air Flow H	m3/h	40080*
	External Static Pressure	Pa	80
Sound	Pressure Level C/H	dB(A)	65.5/69.5
	Power Level C/H	dB(A)	87.5/91.5
Unit(s)	Height x Width x Depth	mm	1690 x 3310 x 780
	Weight	kg	812
Pipe Connections	Refrigerant Base Charge	kg	9 + 6 x2
	Suction Gas Pipe Brazing	inch	1 5/8
	Liquid Pipe Flare	inch	7/8
	Equivalent Length	m	250
	Real Length	m	210
	Total Pipe Length (Liquid Line Real Length)	m	1200
	Length To First Branch	m	100
	Equivalent Length Of Outdoor Unit Connecting Pipe	m	10
	Real Length Of Indoor Unit Connecting Piping	m	30
Maximum	Equivalent Length Between Branches	m	50
	Height Difference Outdoor Higher Than Indoor Units	m	70 (110*)
	Height Difference Outdoor Lower Than Indoor Units	m	40 (110*)
	Height Difference Between Indoor Units	m	40
	Height Difference Between Outdoor Units	m	5
	Electrical	Voltage Range Minimum/Maximum	V
Electrical Characteristic Running Current Cooling/Heating		A	75.70/56.70
Power Supply Wiring Starting Current		A	Soft Start
Power Supply		V/ph/Hz	380-415/3/50
Suggested Fused Supply(s)		A	63 + 40 + 32

\*Combination combined value, see stand alone for individual data

\*All [Accessories](#) / [Controls](#)

Related items:

- [Full specification](#)
- [CAD files](#)
- [Dimensional drawing](#)
- [Connection diagram](#)
- [Noise curve data](#)

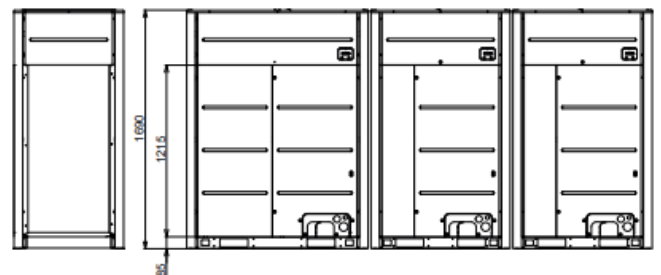

\*For further information see stand alone data

## VRF SMMSu R410a: UP5211HT8P-E

### COMBINATIONS

- Operating conditions from -25°C to +52°C.
- Up to 128 indoor units connected per system.
- Possibility to combine up to 5 outdoor units to achieve 120HP.
- Unique Triple Rotary Compressor and a totally redesigned chassis.
- Up to 1,200m total piping length with 250m from outdoor to the farthest indoor unit.



### Performance & Outdoor Data

Model & Combination		UP5211HT8P-E MUP2401HT8P-E MUP1401HT8P-E x 2		
Capacity Range		HP	52	
Maximum Number of Indoor Units		QTY	75	
Cooling Capacity		kW	147.0	
Heating Capacity		kW	147.0	
Operating Range	Cooling	°C	-5.0 to 52.0	
	Heating		-25.0 to 15.5	
Cooling	Power Consumption	kW	53.29	
	EER/SEER/Energy Efficiency Class (or nsc %)		2.76/6.96/275.4	
Heating	Power Consumption	kW	38.98	
	COP/SCOP/Energy Efficiency Class (or nsc(A) %)		3.77/4.41/173.4	
Fan(s)	Standard Air Flow H	l/s	11183*	
	Standard Air Flow H	m <sup>3</sup> /h	40260*	
	External Static Pressure	Pa	80	
Sound	Pressure Level C/H	dB(A)	65.5/69.5	
	Power Level C/H	dB(A)	87.5/91.5	
Unit(s)	Height x Width x Depth	mm	1690 x 3310 x 780	
	Weight	kg	812	
Pipe Connections	Refrigerant Base Charge	kg	9 + 6 x 2	
	Suction Gas Pipe Brazing	inch	1 5/8	
	Liquid Pipe Flare	inch	7/8	
	Equivalent Length	m	250	
	Real Length	m	210	
	Total Pipe Length (Liquid Line Real Length)	m	1200	
	Length To First Branch	m	100	
	Equivalent Length Of Outdoor Unit Connecting Pipe	m	10	
	Real Length Of Indoor Unit Connecting Piping	m	30	
	Equivalent Length Between Branches	m	50	
Maximum	Height Difference Outdoor Higher Than Indoor Units	m	70 (110*)	
	Height Difference Outdoor Lower Than Indoor Units	m	40 (110*)	
	Height Difference Between Indoor Units	m	40	
	Height Difference Between Outdoor Units	m	5	
	Electrical	Voltage Range Minimum/Maximum	V	342/456
		Electrical Characteristic Running Current Cooling/Heating	A	82.30/60.10
Power Supply Wiring Starting Current		A	Soft Start	
Power Supply		V/ph/Hz	380-415/3/50	
Suggested Fused Supply(s)		A	63 + 40 x 2	

\*Combination combined value, see stand alone for individual data

\*All [Accessories](#) / [Controls](#)

Related items:

- [Full specification](#)
- [CAD files](#)
- [Dimensional drawing](#)
- [Connection diagram](#)
- [Noise curve data](#)

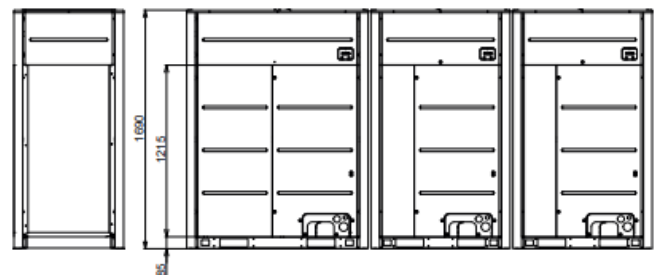

\*For further information see stand alone data

## VRF SMMSu R410a: UP5411HT8P-E

### COMBINATIONS

- Operating conditions from -25°C to +52°C.
- Up to 128 indoor units connected per system.
- Possibility to combine up to 5 outdoor units to achieve 120HP.
- Unique Triple Rotary Compressor and a totally redesigned chassis.
- Up to 1,200m total piping length with 250m from outdoor to the farthest indoor unit.



**SMMSu**  
SUPER MODULAR MULTI SYSTEM



Hi - Res Image

### Performance & Outdoor Data

Model & Combination		UP5411HT8P-E MUP2001HT8P-E x 2 MUP1401HT8P-E	
Capacity Range		HP	54
Maximum Number of Indoor Units		QTY	76
Cooling Capacity		kW	152.0
Heating Capacity		kW	152.0
Operating Range	Cooling	°C	-5.0 to 52.0
	Heating		-25.0 to 15.5
Cooling	Power Consumption	kW	50.57
	EER/SEER/Energy Efficiency Class (or nsc %)		3.01/7.49/296.6
Heating	Power Consumption	kW	39.86
	COP/SCOP/Energy Efficiency Class (or nsc(A) %)		3.81/4.47/175.8
Fan(s)	Standard Air Flow H	l/s	12134*
	Standard Air Flow H	m3/h	43680*
Sound	External Static Pressure	Pa	80
	Pressure Level C/H	dB(A)	67/71
Unit(s)	Power Level C/H	dB(A)	89.5/93.5
	Height x Width x Depth	mm	1690 x 3610 x 780
Pipe Connections	Weight	kg	896
	Refrigerant Base Charge	kg	9 x2 + 6
Maximum	Suction Gas Pipe Brazing	inch	1 5/8
	Liquid Pipe Flare	inch	7/8
Electrical	Equivalent Length	m	200
	Real Length	m	160
	Total Pipe Length (Liquid Line Real Length)	m	1200
	Length To First Branch	m	100
	Equivalent Length Of Outdoor Unit Connecting Pipe	m	10
	Real Length Of Indoor Unit Connecting Piping	m	30
	Equivalent Length Between Branches	m	50
	Height Difference Outdoor Higher Than Indoor Units	m	70 (110*)
	Height Difference Outdoor Lower Than Indoor Units	m	40 (110*)
	Height Difference Between Indoor Units	m	40
Electrical	Height Difference Between Outdoor Units	m	5
	Voltage Range Minimum/Maximum	V	342/456
	Electrical Characteristic Running Current Cooling/Heating	A	78.00/61.30
	Power Supply Wiring Starting Current	A	Soft Start
	Power Supply	V/ph/Hz	380-415/3/50
	Suggested Fused Supply(s)	A	40 x3

\*Combination combined value, see stand alone for individual data

\*All [Accessories](#) / [Controls](#)

Related items:

- [Full specification](#)
- [CAD files](#)
- [Dimensional drawing](#)
- [Connection diagram](#)
- [Noise curve data](#)

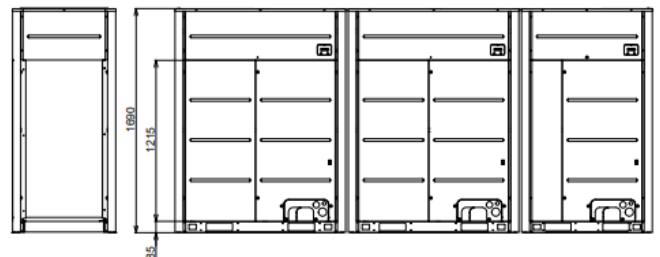

\*For further information see stand alone data

## VRF SMMSu R410a: **UP5611HT8P-E**

### COMBINATIONS

- Operating conditions from -25°C to +52°C.
- Up to 128 indoor units connected per system.
- Possibility to combine up to 5 outdoor units to achieve 120HP.
- Unique Triple Rotary Compressor and a totally redesigned chassis.
- Up to 1,200m total piping length with 250m from outdoor to the farthest indoor unit.



**SMMSu**  
SUPER MODULAR MULTI SYSTEM



Hi - Res Image

### Performance & Outdoor Data

Model & Combination		UP5611HT8P-E MUP2401HT8P-E MUP2001HT8P-E MUP1201HT8P-E	
Capacity Range		HP	56
Maximum Number of Indoor Units		QTY	77
Cooling Capacity		kW	156.5
Heating Capacity		kW	156.5
Operating Range	Cooling	°C	-5.0 to 52.0
	Heating		-25.0 to 15.5
Cooling	Power Consumption	kW	52.54
	EER/SEER/Energy Efficiency Class (or nsc %)		2.98/7.23/286.2
Heating	Power Consumption	kW	41.68
	COP/SCOP/Energy Efficiency Class (or nsc(A) %)		3.75/4.41/173.4
Fan(s)	Standard Air Flow H	l/s	12250*
	Standard Air Flow H	m3/h	44100*
	External Static Pressure	Pa	80
Sound	Pressure Level C/H	dB(A)	67/71
	Power Level C/H	dB(A)	89.5/93.5
Unit(s)	Height x Width x Depth	mm	1690 x 3610 x 780
	Weight	kg	918
Pipe Connections	Refrigerant Base Charge	kg	9 x 2 + 6
	Suction Gas Pipe Brazing	inch	1 5/8
	Liquid Pipe Flare	inch	7/8
	Equivalent Length	m	200
Maximum	Real Length	m	160
	Total Pipe Length (Liquid Line Real Length)	m	1200
	Length To First Branch	m	100
	Equivalent Length Of Outdoor Unit Connecting Pipe	m	10
	Real Length Of Indoor Unit Connecting Piping	m	30
	Equivalent Length Between Branches	m	50
	Height Difference Outdoor Higher Than Indoor Units	m	70 (110*)
	Height Difference Outdoor Lower Than Indoor Units	m	40 (110*)
	Height Difference Between Indoor Units	m	40
	Height Difference Between Outdoor Units	m	5
	Electrical	Voltage Range Minimum/Maximum	V
Electrical Characteristic Running Current Cooling/Heating		A	80.80/64.10
Power Supply Wiring Starting Current		A	Soft Start
Power Supply		V/ph/Hz	380-415/3/50
	Suggested Fused Supply(s)	A	63 + 40 + 32

\*Combination combined value, see stand alone for individual data

\*All [Accessories](#) / [Controls](#)

Related items:

- [Full specification](#)
- [CAD files](#)
- [Dimensional drawing](#)
- [Connection diagram](#)
- [Noise curve data](#)

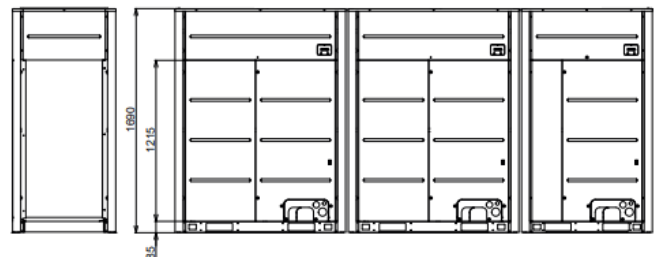

\*For further information see stand alone data

## VRF SMMSu R410a: **UP5811HT8P-E**

### COMBINATIONS

- Operating conditions from -25°C to +52°C.
- Up to 128 indoor units connected per system.
- Possibility to combine up to 5 outdoor units to achieve 120HP.
- Unique Triple Rotary Compressor and a totally redesigned chassis.
- Up to 1,200m total piping length with 250m from outdoor to the farthest indoor unit.



**SMMSu**  
SUPER MODULAR MULTI SYSTEM



Hi - Res Image

### Performance & Outdoor Data

Model & Combination		UP5811HT8P-E MUP2401HT8P-E MUP2001HT8P-E MUP1401HT8P-E	
Capacity Range		HP	58
Maximum Number of Indoor Units		QTY	78
Cooling Capacity		kW	163.0
Heating Capacity		kW	163.0
Operating Range	Cooling	°C	-5.0 to 52.0
	Heating		-25.0 to 15.5
Cooling	Power Consumption	kW	56.75
	EER/SEER/Energy Efficiency Class (or nsc %)		2.87/7.19/284.6
Heating	Power Consumption	kW	43.91
	COP/SCOP/Energy Efficiency Class (or nsc(A) %)		3.71/4.37/171.8
Fan(s)	Standard Air Flow H	l/s	12300*
	Standard Air Flow H	m3/h	44280*
	External Static Pressure	Pa	80
Sound	Pressure Level C/H	dB(A)	67/71
	Power Level C/H		89.5/93.5
Unit(s)	Height x Width x Depth	mm	1690 x 3610 x 780
	Weight		kg
Pipe Connections	Refrigerant Base Charge	kg	9 x 2 + 6
	Suction Gas Pipe Brazing	inch	1 5/8
	Liquid Pipe Flare	inch	7/8
	Equivalent Length	m	200
	Real Length	m	160
	Total Pipe Length (Liquid Line Real Length)	m	1200
	Length To First Branch	m	100
Maximum	Equivalent Length Of Outdoor Unit Connecting Pipe	m	10
	Real Length Of Indoor Unit Connecting Piping	m	30
	Equivalent Length Between Branches	m	50
	Height Difference Outdoor Higher Than Indoor Units	m	70 (110*)
	Height Difference Outdoor Lower Than Indoor Units	m	40 (110*)
	Height Difference Between Indoor Units	m	40
	Height Difference Between Outdoor Units	m	5
Electrical	Voltage Range Minimum/Maximum	V	342/456
	Electrical Characteristic Running Current Cooling/Heating	A	87.40/67.50
	Power Supply Wiring Starting Current	A	Soft Start
	Power Supply	V/ph/Hz	380-415/3/50
	Suggested Fused Supply(s)	A	63 + 40 x 2

\*Combination combined value, see stand alone for individual data

\*All [Accessories](#) / [Controls](#)

Related items:

- [Full specification](#)
- [CAD files](#)
- [Dimensional drawing](#)
- [Connection diagram](#)
- [Noise curve data](#)

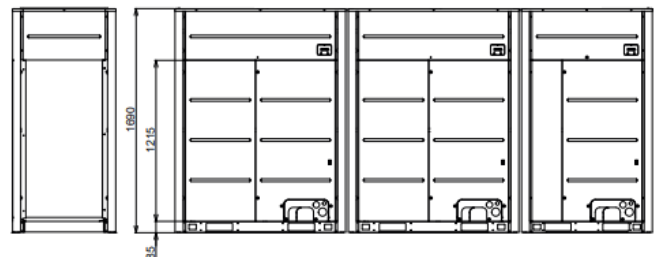

\*For further information see stand alone data

## VRF SMMSu R410a: **UP6011HT8P-E**

### COMBINATIONS

- Operating conditions from -25°C to +52°C.
- Up to 128 indoor units connected per system.
- Possibility to combine up to 5 outdoor units to achieve 120HP.
- Unique Triple Rotary Compressor and a totally redesigned chassis.
- Up to 1,200m total piping length with 250m from outdoor to the farthest indoor unit.



**SMMSu**  
SUPER MODULAR MULTI SYSTEM



Hi - Res Image

### Performance & Outdoor Data

Model & Combination		UP6011HT8P-E MUP2401HT8P-E x 2 MUP1201HT8P-E	
Capacity Range		HP	60
Maximum Number of Indoor Units		QTY	79
Cooling Capacity		kW	167.5
Heating Capacity		kW	167.5
Operating Range	Cooling	°C	-5.0 to 52.0
	Heating		-25.0 to 15.5
Cooling	Power Consumption	kW	58.72
	EER/SEER/Energy Efficiency Class (or nsc %)		2.85/6.95/275.0
Heating	Power Consumption	kW	45.73
	COP/SCOP/Energy Efficiency Class (or nsc(A) %)		3.66/4.30/169.0
Fan(s)	Standard Air Flow H	l/s	12416*
	Standard Air Flow H	m3/h	44700*
	External Static Pressure	Pa	80
Sound	Pressure Level C/H	dB(A)	67/71
	Power Level C/H	dB(A)	89.5/93.5
Unit(s)	Height x Width x Depth	mm	1690 x 3610 x 780
	Weight	kg	940
	Refrigerant Base Charge	kg	9 x2 + 6
Pipe Connections	Suction Gas Pipe Brazing	inch	1 5/8
	Liquid Pipe Flare	inch	7/8
	Equivalent Length	m	200
Maximum	Real Length	m	160
	Total Pipe Length (Liquid Line Real Length)	m	1200
	Length To First Branch	m	100
	Equivalent Length Of Outdoor Unit Connecting Pipe	m	10
	Real Length Of Indoor Unit Connecting Piping	m	30
	Equivalent Length Between Branches	m	50
	Height Difference Outdoor Higher Than Indoor Units	m	70 (110*)
	Height Difference Outdoor Lower Than Indoor Units	m	40 (110*)
	Height Difference Between Indoor Units	m	40
	Height Difference Between Outdoor Units	m	5
	Electrical	Voltage Range Minimum/Maximum	V
Electrical Characteristic Running Current Cooling/Heating		A	90.20/70.30
Power Supply Wiring Starting Current		A	Soft Start
Power Supply		V/ph/Hz	380-415/3/50
Suggested Fused Supply(s)		A	63 x2 + 32

\*Combination combined value, see stand alone for individual data

\*All [Accessories](#) / [Controls](#)

Related items:

- [Full specification](#)
- [CAD files](#)
- [Dimensional drawing](#)
- [Connection diagram](#)
- [Noise curve data](#)

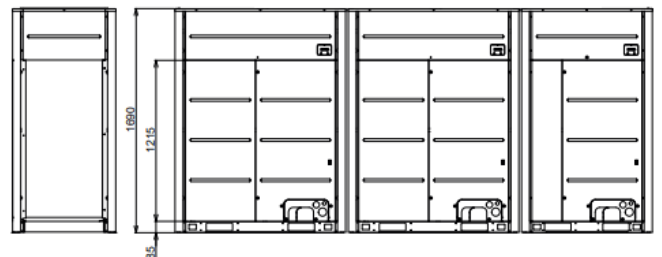

\*For further information see stand alone data

## VRF SMMSu R410a: **UP6211HT8P-E**

### COMBINATIONS

- Operating conditions from -25°C to +52°C.
- Up to 128 indoor units connected per system.
- Possibility to combine up to 5 outdoor units to achieve 120HP.
- Unique Triple Rotary Compressor and a totally redesigned chassis.
- Up to 1,200m total piping length with 250m from outdoor to the farthest indoor unit.



**SMMSu**  
SUPER MODULAR MULTI SYSTEM



Hi - Res Image

### Performance & Outdoor Data

Model & Combination		UP6211HT8P-E MUP2401HT8P-E x 2 MUP1401HT8P-E	
Capacity Range		HP	62
Maximum Number of Indoor Units		QTY	80
Cooling Capacity		kW	174.0
Heating Capacity		kW	174.0
Operating Range	Cooling	°C	-5.0 to 52.0
	Heating		-25.0 to 15.5
Cooling	Power Consumption	kW	62.93
	EER/SEER/Energy Efficiency Class (or nsc %)		2.76/6.92/273.8
Heating	Power Consumption	kW	47.96
	COP/SCOP/Energy Efficiency Class (or nsc(A) %)		3.63/4.27/167.8
Fan(s)	Standard Air Flow H	l/s	12466*
	Standard Air Flow H	m3/h	44880*
	External Static Pressure	Pa	80
Sound	Pressure Level C/H	dB(A)	67/71
	Power Level C/H	dB(A)	89.5/93.5
Unit(s)	Height x Width x Depth	mm	1690 x 3610 x 780
	Weight	kg	940
Pipe Connections	Refrigerant Base Charge	kg	9 x 2 + 6
	Suction Gas Pipe Brazing	inch	1 5/8
	Liquid Pipe Flare	inch	7/8
Maximum	Equivalent Length	m	200
	Real Length	m	160
	Total Pipe Length (Liquid Line Real Length)	m	1200
	Length To First Branch	m	100
	Equivalent Length Of Outdoor Unit Connecting Pipe	m	10
	Real Length Of Indoor Unit Connecting Piping	m	30
	Equivalent Length Between Branches	m	50
	Height Difference Outdoor Higher Than Indoor Units	m	70 (110*)
	Height Difference Outdoor Lower Than Indoor Units	m	40 (110*)
	Height Difference Between Indoor Units	m	40
	Height Difference Between Outdoor Units	m	5
Electrical	Voltage Range Minimum/Maximum	V	342/456
	Electrical Characteristic Running Current Cooling/Heating	A	96.80/73.70
	Power Supply Wiring Starting Current	A	Soft Start
	Power Supply	V/ph/Hz	380-415/3/50
	Suggested Fused Supply(s)	A	63 x 2 + 40

\*Combination combined value, see stand alone for individual data

\*All [Accessories](#) / [Controls](#)

Related items:

- [Full specification](#)
- [CAD files](#)
- [Dimensional drawing](#)
- [Connection diagram](#)
- [Noise curve data](#)

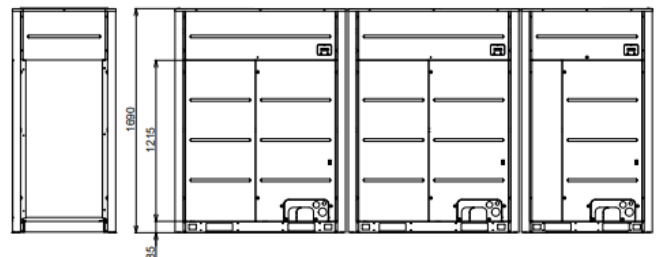

\*For further information see stand alone data



## VRF SMMSu R410a: UP6411HT8P-E

### COMBINATIONS

- Operating conditions from -25°C to +52°C.
- Up to 128 indoor units connected per system.
- Possibility to combine up to 5 outdoor units to achieve 120HP.
- Unique Triple Rotary Compressor and a totally redesigned chassis.
- Up to 1,200m total piping length with 250m from outdoor to the farthest indoor unit.



**SMMSu**  
SUPER MODULAR MULTI SYSTEM



Hi - Res Image

### Performance & Outdoor Data

Model & Combination		UP6411HT8P-E MUP2401HT8P-E MUP2001HT8P-E x 2	
Capacity Range		HP	64
Maximum Number of Indoor Units		QTY	81
Cooling Capacity		kW	179.0
Heating Capacity		kW	179.0
Operating Range	Cooling	°C	-5.0 to 52.0
	Heating		-25.0 to 15.5
Cooling	Power Consumption	kW	60.21
	EER/SEER/Energy Efficiency Class (or nsc %)		2.97/7.34/290.6
Heating	Power Consumption	kW	48.84
	COP/SCOP/Energy Efficiency Class (or nsc(A) %)		3.67/4.34/170.6
Fan(s)	Standard Air Flow H	l/s	13417*
	Standard Air Flow H	m3/h	48300*
Sound	External Static Pressure	Pa	80
	Pressure Level C/H	dB(A)	68/72
Unit(s)	Power Level C/H	dB(A)	91/95
	Height x Width x Depth	mm	1690 x 3910 x 780
Pipe Connections	Weight	kg	1024
	Refrigerant Base Charge	kg	9 x3
Maximum	Suction Gas Pipe Brazing	inch	1 5/8
	Liquid Pipe Flare	inch	7/8
Electrical	Equivalent Length	m	200
	Real Length	m	160
	Total Pipe Length (Liquid Line Real Length)	m	1200
	Length To First Branch	m	100
	Equivalent Length Of Outdoor Unit Connecting Pipe	m	10
	Real Length Of Indoor Unit Connecting Piping	m	30
	Equivalent Length Between Branches	m	50
	Height Difference Outdoor Higher Than Indoor Units	m	70 (110*)
	Height Difference Outdoor Lower Than Indoor Units	m	40 (110*)
	Height Difference Between Indoor Units	m	40
Electrical	Height Difference Between Outdoor Units	m	5
	Voltage Range Minimum/Maximum	V	342/456
	Electrical Characteristic Running Current Cooling/Heating	A	92.50/74.90
	Power Supply Wiring Starting Current	A	Soft Start
	Power Supply	V/ph/Hz	380-415/3/50
	Suggested Fused Supply(s)	A	63 + 40 x 2

\*Combination combined value, see stand alone for individual data

\*All [Accessories](#) / [Controls](#)

Related items:

- [Full specification](#)
- [CAD files](#)
- [Dimensional drawing](#)
- [Connection diagram](#)
- [Noise curve data](#)

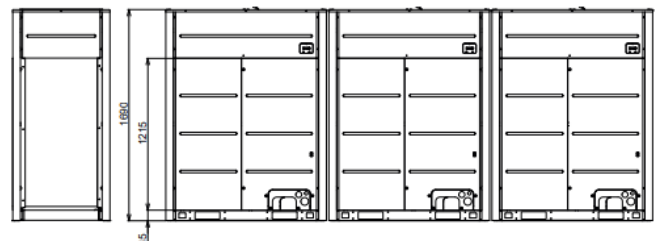

\*For further information see stand alone data

## VRF SMMSu R410a: **UP6611HT8P-E**

### COMBINATIONS

- Operating conditions from -25°C to +52°C.
- Up to 128 indoor units connected per system.
- Possibility to combine up to 5 outdoor units to achieve 120HP.
- Unique Triple Rotary Compressor and a totally redesigned chassis.
- Up to 1,200m total piping length with 250m from outdoor to the farthest indoor unit.



**SMMSu**  
SUPER MODULAR MULTI SYSTEM



Hi - Res Image

### Performance & Outdoor Data

Model & Combination		UP6611HT8P-E MUP2401HT8P-E MUP2201HT8P-E MUP2001HT8P-E	
Capacity Range		HP	66
Maximum Number of Indoor Units		QTY	82
Cooling Capacity		kW	184.5
Heating Capacity		kW	184.5
Operating Range	Cooling	°C	-5.0 to 52.0
	Heating		-25.0 to 15.5
Cooling	Power Consumption	kW	62.63
	EER/SEER/Energy Efficiency Class (or nsc %)		2.95/7.21/285.4
Heating	Power Consumption	kW	50.09
	COP/SCOP/Energy Efficiency Class (or nsc(A) %)		3.68/4.35/171.0
Fan(s)	Standard Air Flow H	l/s	13583*
	Standard Air Flow H	m3/h	48900*
	External Static Pressure	Pa	80
Sound	Pressure Level C/H	dB(A)	68/72
	Power Level C/H	dB(A)	91/95
Unit(s)	Height x Width x Depth	mm	1690 x 3910 x 780
	Weight	kg	1046
Pipe Connections	Refrigerant Base Charge	kg	9 x 3
	Suction Gas Pipe Brazing	inch	1 5/8
	Liquid Pipe Flare	inch	7/8
	Equivalent Length	m	200
	Real Length	m	160
	Total Pipe Length (Liquid Line Real Length)	m	1200
	Length To First Branch	m	100
	Equivalent Length Of Outdoor Unit Connecting Pipe	m	10
	Real Length Of Indoor Unit Connecting Piping	m	30
	Equivalent Length Between Branches	m	50
Maximum	Height Difference Outdoor Higher Than Indoor Units	m	70 (110*)
	Height Difference Outdoor Lower Than Indoor Units	m	40 (110*)
	Height Difference Between Indoor Units	m	40
	Height Difference Between Outdoor Units	m	5
	Electrical	Voltage Range Minimum/Maximum	V
	Electrical Characteristic Running Current Cooling/Heating	A	96.20/76.80
	Power Supply Wiring Starting Current	A	Soft Start
	Power Supply	V/ph/Hz	380-415/3/50
	Suggested Fused Supply(s)	A	63 + 50 + 40

\*Combination combined value, see stand alone for individual data

\*All [Accessories](#) / [Controls](#)

Related items:

- [Full specification](#)
- [CAD files](#)
- [Dimensional drawing](#)
- [Connection diagram](#)
- [Noise curve data](#)

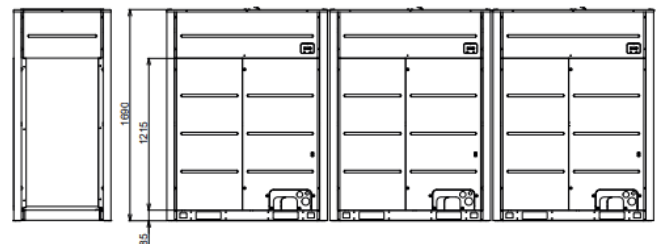

\*For further information see stand alone data

## VRF SMMSu R410a: **UP6811HT8P-E**

### COMBINATIONS

- Operating conditions from -25°C to +52°C.
- Up to 128 indoor units connected per system.
- Possibility to combine up to 5 outdoor units to achieve 120HP.
- Unique Triple Rotary Compressor and a totally redesigned chassis.
- Up to 1,200m total piping length with 250m from outdoor to the farthest indoor unit.



**SMMSu**  
SUPER MODULAR MULTI SYSTEM



Hi - Res Image

### Performance & Outdoor Data

Model & Combination		<b>UP6811HT8P-E</b> MUP2401HT8P-E x 2 MUP2001HT8P-E	
Capacity Range		HP	68
Maximum Number of Indoor Units		QTY	83
Cooling Capacity		kW	190.0
Heating Capacity		kW	190.0
Operating Range	Cooling	°C	-5.0 to 52.0
	Heating		-25.0 to 15.5
Cooling	Power Consumption	kW	66.39
	EER/SEER/Energy Efficiency Class (or nsc %)		2.86/7.09/280.6
Heating	Power Consumption	kW	52.89
	COP/SCOP/Energy Efficiency Class (or nsc(A) %)		3.59/4.26/167.4
Fan(s)	Standard Air Flow H	l/s	13583*
	Standard Air Flow H	m3/h	48900*
	External Static Pressure	Pa	80
Sound	Pressure Level C/H	dB(A)	68/72
	Power Level C/H	dB(A)	91/95
Unit(s)	Height x Width x Depth	mm	1690 x 3910 x 780
	Weight	kg	1046
Pipe Connections	Refrigerant Base Charge	kg	9 x 3
	Suction Gas Pipe Brazing	inch	1 5/8
	Liquid Pipe Flare	inch	7/8
	Equivalent Length	m	200
	Real Length	m	160
	Total Pipe Length (Liquid Line Real Length)	m	1200
	Length To First Branch	m	100
	Equivalent Length Of Outdoor Unit Connecting Pipe	m	10
	Real Length Of Indoor Unit Connecting Piping	m	30
	Equivalent Length Between Branches	m	50
Maximum	Height Difference Outdoor Higher Than Indoor Units	m	70 (110*)
	Height Difference Outdoor Lower Than Indoor Units	m	40 (110*)
	Height Difference Between Indoor Units	m	40
	Height Difference Between Outdoor Units	m	5
	Electrical	Voltage Range Minimum/Maximum	V
	Electrical Characteristic Running Current Cooling/Heating	A	101.90/81.10
	Power Supply Wiring Starting Current	A	Soft Start
	Power Supply	V/ph/Hz	380-415/3/50
	Suggested Fused Supply(s)	A	63 x 2 + 40

\*Combination combined value, see stand alone for individual data

\*All [Accessories](#) / [Controls](#)

Related items:

- [Full specification](#)
- [CAD files](#)
- [Dimensional drawing](#)
- [Connection diagram](#)
- [Noise curve data](#)

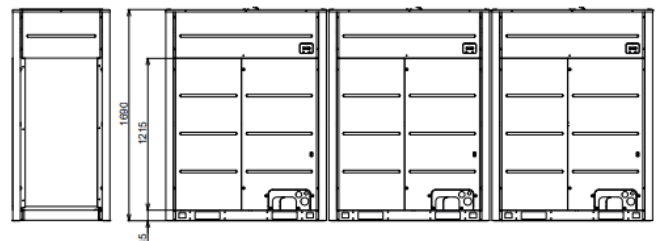

\*For further information see stand alone data

## VRF SMMSu R410a: **UP7011HT8P-E**

### COMBINATIONS

- Operating conditions from -25°C to +52°C.
- Up to 128 indoor units connected per system.
- Possibility to combine up to 5 outdoor units to achieve 120HP.
- Unique Triple Rotary Compressor and a totally redesigned chassis.
- Up to 1,200m total piping length with 250m from outdoor to the farthest indoor unit.



**SMMSu**  
SUPER MODULAR MULTI SYSTEM



Hi - Res Image

### Performance & Outdoor Data

Model & Combination		UP7011HT8P-E MUP2401HT8P-E x 2 MUP2201HT8P-E		
Capacity Range		HP	70	
Maximum Number of Indoor Units		QTY	84	
Cooling Capacity		kW	195.5	
Heating Capacity		kW	195.5	
Operating Range	Cooling	°C	-5.0 to 52.0	
	Heating		-25.0 to 15.5	
Cooling	Power Consumption	kW	68.81	
	EER/SEER/Energy Efficiency Class (or nsc %)		2.84/6.98/276.2	
Heating	Power Consumption	kW	54.14	
	COP/SCOP/Energy Efficiency Class (or nsc(A) %)		3.61/4.26/167.4	
Fan(s)	Standard Air Flow H	l/s	13749*	
	Standard Air Flow H	m3/h	49500*	
	External Static Pressure	Pa	80	
Sound	Pressure Level C/H	dB(A)	68/72	
	Power Level C/H	dB(A)	91/95	
Unit(s)	Height x Width x Depth	mm	1690 x 3910 x 780	
	Weight	kg	1068	
Pipe Connections	Refrigerant Base Charge	kg	9 x 3	
	Suction Gas Pipe Brazing	inch	1 5/8	
	Liquid Pipe Flare	inch	7/8	
Maximum	Equivalent Length	m	200	
	Real Length	m	160	
	Total Pipe Length (Liquid Line Real Length)	m	1200	
	Length To First Branch	m	100	
	Equivalent Length Of Outdoor Unit Connecting Pipe	m	10	
	Real Length Of Indoor Unit Connecting Piping	m	30	
	Equivalent Length Between Branches	m	50	
	Height Difference Outdoor Higher Than Indoor Units	m	70 (110*)	
	Height Difference Outdoor Lower Than Indoor Units	m	40 (110*)	
	Height Difference Between Indoor Units	m	40	
	Height Difference Between Outdoor Units	m	5	
	Electrical	Voltage Range Minimum/Maximum	V	342/456
		Electrical Characteristic Running Current Cooling/Heating	A	105.60/83.00
Power Supply Wiring Starting Current		A	Soft Start	
Power Supply		V/ph/Hz	380-415/3/50	
	Suggested Fused Supply(s)	A	63 x 2 + 50	

\*Combination combined value, see stand alone for individual data

\*All [Accessories / Controls](#)

Related items:

- [Full specification](#)
- [CAD files](#)
- [Dimensional drawing](#)
- [Connection diagram](#)
- [Noise curve data](#)

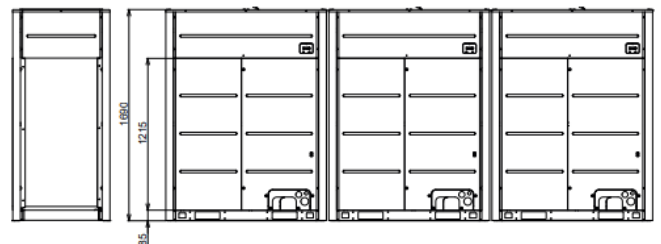

\*For further information see stand alone data

## VRF SMMSu R410a: **UP7211HT8P-E**

### COMBINATIONS

- Operating conditions from -25°C to +52°C.
- Up to 128 indoor units connected per system.
- Possibility to combine up to 5 outdoor units to achieve 120HP.
- Unique Triple Rotary Compressor and a totally redesigned chassis.
- Up to 1,200m total piping length with 250m from outdoor to the farthest indoor unit.



**SMMSu**  
SUPER MODULAR MULTI SYSTEM



Hi - Res Image

### Performance & Outdoor Data

Model & Combination		<b>UP7211HT8P-E</b> MUP2401HT8P-E x 3	
Capacity Range		HP	72
Maximum Number of Indoor Units		QTY	85
Cooling Capacity		kW	201.0
Heating Capacity		kW	201.0
Operating Range	Cooling	°C	-5.0 to 52.0
	Heating		-25.0 to 15.5
Cooling	Power Consumption	kW	72.57
	EER/SEER/Energy Efficiency Class (or nsc %)		2.77/6.87/271.8
Heating	Power Consumption	kW	56.94
	COP/SCOP/Energy Efficiency Class (or nsc(A) %)		3.53/4.17/163.8
Fan(s)	Standard Air Flow H	l/s	13749*
	Standard Air Flow H	m <sup>3</sup> /h	49500*
	External Static Pressure	Pa	80
Sound	Pressure Level C/H	dB(A)	68/72
	Power Level C/H	dB(A)	91/95
Unit(s)	Height x Width x Depth	mm	1690 x 3910 x 780
	Weight	kg	1068
Pipe Connections	Refrigerant Base Charge	kg	9 x 3
	Suction Gas Pipe Brazing	inch	1 5/8
Maximum	Liquid Pipe Flare	inch	7/8
	Equivalent Length	m	200
	Real Length	m	160
	Total Pipe Length (Liquid Line Real Length)	m	1200
	Length To First Branch	m	100
	Equivalent Length Of Outdoor Unit Connecting Pipe	m	10
	Real Length Of Indoor Unit Connecting Piping	m	30
	Equivalent Length Between Branches	m	50
	Height Difference Outdoor Higher Than Indoor Units	m	70 (110*)
	Height Difference Outdoor Lower Than Indoor Units	m	40 (110*)
	Height Difference Between Indoor Units	m	40
	Height Difference Between Outdoor Units	m	5
Electrical	Voltage Range Minimum/Maximum	V	342/456
	Electrical Characteristic Running Current Cooling/Heating	A	111.30/87.30
	Power Supply Wiring Starting Current	A	Soft Start
	Power Supply	V/ph/Hz	380-415/3/50
	Suggested Fused Supply(s)	A	63 x 3

\*Combination combined value, see stand alone for individual data

\*All [Accessories](#) / [Controls](#)

Related items:

- [Full specification](#)
- [CAD files](#)
- [Dimensional drawing](#)
- [Connection diagram](#)
- [Noise curve data](#)

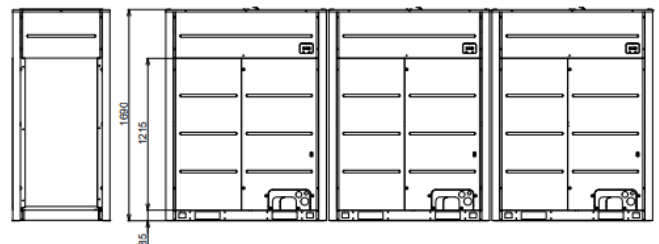

\*For further information see stand alone data

## VRF SMMSu R410a: UP7411HT8P-E

### COMBINATIONS

- Operating conditions from -25°C to +52°C.
- Up to 128 indoor units connected per system.
- Possibility to combine up to 5 outdoor units to achieve 120HP.
- Unique Triple Rotary Compressor and a totally redesigned chassis.
- Up to 1,200m total piping length with 250m from outdoor to the farthest indoor unit.



**SMMSu**  
SUPER MODULAR MULTI SYSTEM



Hi - Res Image

### Performance & Outdoor Data

Model & Combination		UP7411HT8P-E MUP2401HT8P-E x 2 MUP1401HT8P-E MUP1201HT8P-E		
Capacity Range		HP	74	
Maximum Number of Indoor Units		QTY	86	
Cooling Capacity		kW	207.5	
Heating Capacity		kW	207.5	
Operating Range	Cooling	°C	-5.0 to 52.0	
	Heating		-25.0 to 15.5	
Cooling	Power Consumption	kW	73.27	
	EER/SEER/Energy Efficiency Class (or nsc %)		2.83/6.97/275.8	
Heating	Power Consumption	kW	55.73	
	COP/SCOP/Energy Efficiency Class (or nsc(A) %)		3.72/4.36/171.4	
Fan(s)	Standard Air Flow H	l/s	15716*	
	Standard Air Flow H	m3/h	56580*	
	External Static Pressure	Pa	80	
Sound	Pressure Level C/H	dB(A)	67.5/71.5	
	Power Level C/H	dB(A)	90/94	
Unit(s)	Height x Width x Depth	mm	1690 x 4620 x 780	
	Weight	kg	1168	
	Refrigerant Base Charge	kg	9 x2 + 6 x2	
Pipe Connections	Suction Gas Pipe Brazing	inch	1 5/8	
	Liquid Pipe Flare	inch	7/8	
	Equivalent Length	m	200	
Maximum	Real Length	m	160	
	Total Pipe Length (Liquid Line Real Length)	m	1200	
	Length To First Branch	m	100	
	Equivalent Length Of Outdoor Unit Connecting Pipe	m	10	
	Real Length Of Indoor Unit Connecting Piping	m	30	
	Equivalent Length Between Branches	m	50	
	Height Difference Outdoor Higher Than Indoor Units	m	70 (110*)	
	Height Difference Outdoor Lower Than Indoor Units	m	40 (110*)	
	Height Difference Between Indoor Units	m	40	
	Height Difference Between Outdoor Units	m	5	
	Electrical	Voltage Range Minimum/Maximum	V	342/456
		Electrical Characteristic Running Current Cooling/Heating	A	112.80/85.80
Power Supply Wiring Starting Current		A	Soft Start	
Power Supply		V/ph/Hz	380-415/3/50	
Suggested Fused Supply(s)		A	63 x 2 + 40 + 32	

\*Combination combined value, see stand alone for individual data

\*All [Accessories](#) / [Controls](#)

Related items:

- [Full specification](#)
- [CAD files](#)
- [Dimensional drawing](#)
- [Connection diagram](#)
- [Noise curve data](#)

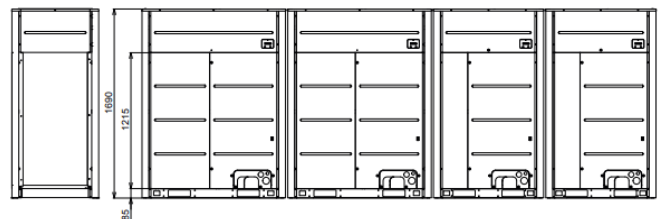

\*For further information see stand alone data

## VRF SMMSu R410a: UP7611HT8P-E

### COMBINATIONS

- Operating conditions from -25°C to +52°C.
- Up to 128 indoor units connected per system.
- Possibility to combine up to 5 outdoor units to achieve 120HP.
- Unique Triple Rotary Compressor and a totally redesigned chassis.
- Up to 1,200m total piping length with 250m from outdoor to the farthest indoor unit.



**SMMSu**  
SUPER MODULAR MULTI SYSTEM



Hi - Res Image

### Performance & Outdoor Data

Model & Combination		UP7611HT8P-E	
		MUP2401HT8P-E x 2 MUP1401HT8P-E x 2	
Capacity Range		HP	76
Maximum Number of Indoor Units		QTY	87
Cooling Capacity		kW	214.0
Heating Capacity		kW	214.0
Operating Range	Cooling	°C	-5.0 to 52.0
	Heating		-25.0 to 15.5
Cooling	Power Consumption	kW	77.48
	EER/SEER/Energy Efficiency Class (or nsc %)		2.76/6.93/274.2
Heating	Power Consumption	kW	57.96
	COP/SCOP/Energy Efficiency Class (or nsc(A) %)		3.69/4.33/170.2
Fan(s)	Standard Air Flow H	l/s	15766*
	Standard Air Flow H	m3/h	56760*
Sound	External Static Pressure	Pa	80
	Pressure Level C/H	dB(A)	67.5/71.5
Unit(s)	Power Level C/H	dB(A)	90/94
	Height x Width x Depth	mm	1690 x 4620 x 780
Pipe Connections	Weight	kg	1168
	Refrigerant Base Charge	kg	9 x2 + 6 x2
Maximum	Suction Gas Pipe Brazing	inch	2 1/8
	Liquid Pipe Flare	inch	7/8
Electrical	Equivalent Length	m	200
	Real Length	m	160
	Total Pipe Length (Liquid Line Real Length)	m	1200
	Length To First Branch	m	100
	Equivalent Length Of Outdoor Unit Connecting Pipe	m	10
	Real Length Of Indoor Unit Connecting Piping	m	30
	Equivalent Length Between Branches	m	50
	Height Difference Outdoor Higher Than Indoor Units	m	70 (110*)
	Height Difference Outdoor Lower Than Indoor Units	m	40 (110*)
	Height Difference Between Indoor Units	m	40
Electrical	Height Difference Between Outdoor Units	m	5
	Voltage Range Minimum/Maximum	V	342/456
	Electrical Characteristic Running Current Cooling/Heating	A	119.40/89.20
	Power Supply Wiring Starting Current	A	Soft Start
	Power Supply	V/ph/Hz	380-415/3/50
	Suggested Fused Supply(s)	A	63 x2 + 40 x2

\*Combination combined value, see stand alone for individual data

\*All [Accessories](#) / [Controls](#)

Related items:

- [Full specification](#)
- [CAD files](#)
- [Dimensional drawing](#)
- [Connection diagram](#)
- [Noise curve data](#)

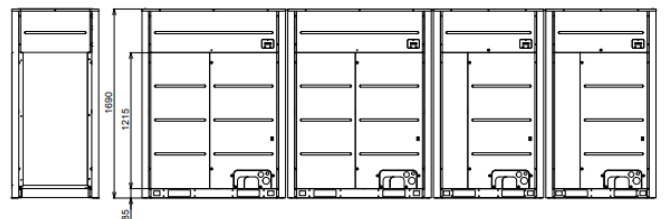

\*For further information see stand alone data

## VRF SMMSu R410a: **UP7811HT8P-E**

### COMBINATIONS

- Operating conditions from -25°C to +52°C.
- Up to 128 indoor units connected per system.
- Possibility to combine up to 5 outdoor units to achieve 120HP.
- Unique Triple Rotary Compressor and a totally redesigned chassis.
- Up to 1,200m total piping length with 250m from outdoor to the farthest indoor unit.



**SMMSu**  
SUPER MODULAR MULTI SYSTEM



Hi - Res Image

### Performance & Outdoor Data

Model & Combination		UP7811HT8P-E MUP2401HT8P-E MUP2001HT8P-E x 2 MUP1401HT8P-E	
Capacity Range		HP	78
Maximum Number of Indoor Units		QTY	88
Cooling Capacity		kW	219.0
Heating Capacity		kW	219.0
Operating Range	Cooling	°C	-5.0 to 52.0
	Heating		-25.0 to 15.5
Cooling	Power Consumption	kW	74.76
	EER/SEER/Energy Efficiency Class (or nsc %)		2.93/7.30/289.0
Heating	Power Consumption	kW	58.84
	COP/SCOP/Energy Efficiency Class (or nsc(A) %)		3.72/4.39/172.6
Fan(s)	Standard Air Flow H	l/s	16717*
	Standard Air Flow H	m3/h	60180*
	External Static Pressure	Pa	80
Sound	Pressure Level C/H	dB(A)	68.5/72.5
	Power Level C/H	dB(A)	91.5/95
Unit(s)	Height x Width x Depth	mm	1690 x 4920 x 780
	Weight	kg	1252
Pipe Connections	Refrigerant Base Charge	kg	9 x 3 + 6
	Suction Gas Pipe Brazing	inch	2 1/8
	Liquid Pipe Flare	inch	7/8
	Equivalent Length	m	200
	Real Length	m	160
	Total Pipe Length (Liquid Line Real Length)	m	1200
	Length To First Branch	m	100
	Equivalent Length Of Outdoor Unit Connecting Pipe	m	10
Maximum	Real Length Of Indoor Unit Connecting Piping	m	30
	Equivalent Length Between Branches	m	50
	Height Difference Outdoor Higher Than Indoor Units	m	70 (110*)
	Height Difference Outdoor Lower Than Indoor Units	m	40 (110*)
	Height Difference Between Indoor Units	m	40
	Height Difference Between Outdoor Units	m	5
Electrical	Voltage Range Minimum/Maximum	V	342/456
	Electrical Characteristic Running Current Cooling/Heating	A	115.10/90.40
	Power Supply Wiring Starting Current	A	Soft Start
	Power Supply	V/ph/Hz	380-415/3/50
	Suggested Fused Supply(s)	A	63 + 40 x 3

\*Combination combined value, see stand alone for individual data

\*All [Accessories / Controls](#)

Related items:

- [Full specification](#)
- [CAD files](#)
- [Dimensional drawing](#)
- [Connection diagram](#)
- [Noise curve data](#)

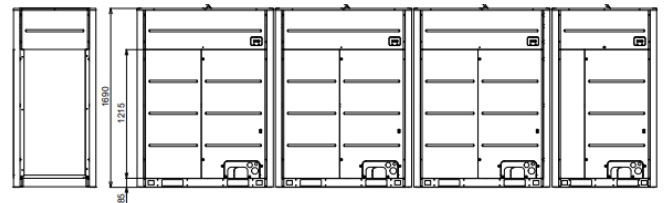

\*For further information see stand alone data



## VRF SMMSu R410a: **UP801 1HT8P-E**

### COMBINATIONS

- Operating conditions from -25°C to +52°C.
- Up to 128 indoor units connected per system.
- Possibility to combine up to 5 outdoor units to achieve 120HP.
- Unique Triple Rotary Compressor and a totally redesigned chassis.
- Up to 1,200m total piping length with 250m from outdoor to the farthest indoor unit.



**SMMSu**  
SUPER MODULAR MULTI SYSTEM



Hi - Res Image

### Performance & Outdoor Data

Model & Combination		<b>UP801 1HT8P-E</b> MUP2401HT8P-E x 2 MUP2001HT8P-E MUP1201HT8P-E	
Capacity Range		HP	80
Maximum Number of Indoor Units		QTY	90
Cooling Capacity		kW	223.5
Heating Capacity		kW	223.5
Operating Range	Cooling	°C	-5.0 to 52.0
	Heating		-25.0 to 15.5
Cooling	Power Consumption	kW	76.73
	EER/SEER/Energy Efficiency Class (or nsc %)		2.91/7.14/282.6
Heating	Power Consumption	kW	60.66
	COP/SCOP/Energy Efficiency Class (or nsc(A) %)		3.68/4.34/170.6
Fan(s)	Standard Air Flow H	l/s	16833*
	Standard Air Flow H	m3/h	60600*
	External Static Pressure	Pa	80
Sound	Pressure Level C/H	dB(A)	68.5/72.5
	Power Level C/H	dB(A)	91.5/95
Unit(s)	Height x Width x Depth	mm	1690 x 4920 x 780
	Weight	kg	1274
Pipe Connections	Refrigerant Base Charge	kg	9 x 3 + 6
	Suction Gas Pipe Brazing	inch	2 1/8
	Liquid Pipe Flare	inch	7/8
	Equivalent Length	m	200
	Real Length	m	160
	Total Pipe Length (Liquid Line Real Length)	m	1200
	Length To First Branch	m	100
	Equivalent Length Of Outdoor Unit Connecting Pipe	m	10
	Real Length Of Indoor Unit Connecting Piping	m	30
	Equivalent Length Between Branches	m	50
Maximum	Height Difference Outdoor Higher Than Indoor Units	m	70 (110*)
	Height Difference Outdoor Lower Than Indoor Units	m	40 (110*)
	Height Difference Between Indoor Units	m	40
	Height Difference Between Outdoor Units	m	5
	Electrical	Voltage Range Minimum/Maximum	V
	Electrical Characteristic Running Current Cooling/Heating	A	117.90/93.20
	Power Supply Wiring Starting Current	A	Soft Start
	Power Supply	V/ph/Hz	380-415/3/50
	Suggested Fused Supply(s)	A	63 x 2 + 40 + 32

\*Combination combined value, see stand alone for individual data

\*All [Accessories](#) / [Controls](#)

Related items:

- [Full specification](#)
- [CAD files](#)
- [Dimensional drawing](#)
- [Connection diagram](#)
- [Noise curve data](#)

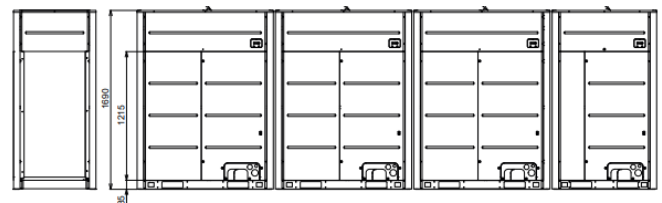

\*For further information see stand alone data

## VRF SMMSu R410a: UP821 1HT8P-E

### COMBINATIONS

- Operating conditions from -25°C to +52°C.
- Up to 128 indoor units connected per system.
- Possibility to combine up to 5 outdoor units to achieve 120HP.
- Unique Triple Rotary Compressor and a totally redesigned chassis.
- Up to 1,200m total piping length with 250m from outdoor to the farthest indoor unit.



**SMMSu**  
SUPER MODULAR MULTI SYSTEM

Hi - Res Image

### Performance & Outdoor Data

Model & Combination		UP821 1HT8P-E MUP2401HT8P-E x 2 MUP2001HT8P-E MUP1401HT8P-E	
Capacity Range		HP	82
Maximum Number of Indoor Units		QTY	92
Cooling Capacity		kW	230.0
Heating Capacity		kW	230.0
Operating Range	Cooling	°C	-5.0 to 52.0
	Heating		-25.0 to 15.5
Cooling	Power Consumption	kW	80.94
	EER/SEER/Energy Efficiency Class (or nsc %)		2.84/7.10/281.0
Heating	Power Consumption	kW	62.89
	COP/SCOP/Energy Efficiency Class (or nsc(A) %)		3.66/4.32/169.8
Fan(s)	Standard Air Flow H	l/s	16883*
	Standard Air Flow H	m3/h	60780*
	External Static Pressure	Pa	80
Sound	Pressure Level C/H	dB(A)	68.5/72.5
	Power Level C/H	dB(A)	91.5/95
Unit(s)	Height x Width x Depth	mm	1690 x 4920 x 780
	Weight	kg	1274
Pipe Connections	Refrigerant Base Charge	kg	9 x3 + 6
	Suction Gas Pipe Brazing	inch	2 1/8
	Liquid Pipe Flare	inch	7/8
	Equivalent Length	m	200
	Real Length	m	160
	Total Pipe Length (Liquid Line Real Length)	m	1200
	Length To First Branch	m	100
	Equivalent Length Of Outdoor Unit Connecting Pipe	m	10
	Real Length Of Indoor Unit Connecting Piping	m	30
	Equivalent Length Between Branches	m	50
Maximum	Height Difference Outdoor Higher Than Indoor Units	m	70 (110*)
	Height Difference Outdoor Lower Than Indoor Units	m	40 (110*)
	Height Difference Between Indoor Units	m	40
	Height Difference Between Outdoor Units	m	5
	Electrical	Voltage Range Minimum/Maximum	V
	Electrical Characteristic Running Current Cooling/Heating	A	124.50/96.60
	Power Supply Wiring Starting Current	A	Soft Start
	Power Supply	V/ph/Hz	380-415/3/50
	Suggested Fused Supply(s)	A	63 x 2 + 40 x 2

\*Combination combined value, see stand alone for individual data

\*All [Accessories](#) / [Controls](#)

Related items:

- [Full specification](#)
- [CAD files](#)
- [Dimensional drawing](#)
- [Connection diagram](#)
- [Noise curve data](#)

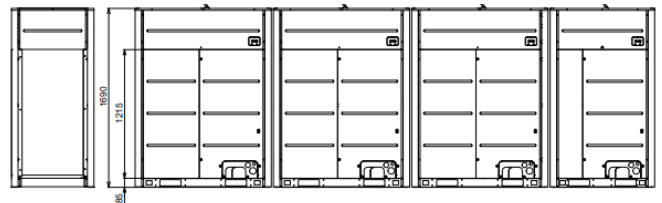

\*For further information see stand alone data

## VRF SMMSu R410a: UP8411HT8P-E

### COMBINATIONS

- Operating conditions from -25°C to +52°C.
- Up to 128 indoor units connected per system.
- Possibility to combine up to 5 outdoor units to achieve 120HP.
- Unique Triple Rotary Compressor and a totally redesigned chassis.
- Up to 1,200m total piping length with 250m from outdoor to the farthest indoor unit.



**SMMSu**  
SUPER MODULAR MULTI SYSTEM



Hi - Res Image

### Performance & Outdoor Data

Model & Combination		UP8411HT8P-E MUP2401HT8P-E x 3 MUP1201HT8P-E	
Capacity Range		HP	84
Maximum Number of Indoor Units		QTY	94
Cooling Capacity		kW	234.5
Heating Capacity		kW	234.5
Operating Range	Cooling	°C	-5.0 to 52.0
	Heating		-25.0 to 15.5
Cooling	Power Consumption	kW	82.91
	EER/SEER/Energy Efficiency Class (or nsc %)		2.83/6.95/275.0
Heating	Power Consumption	kW	64.71
	COP/SCOP/Energy Efficiency Class (or nsc(A) %)		3.62/4.26/167.4
Fan(s)	Standard Air Flow H	l/s	16999*
	Standard Air Flow H	m3/h	61200*
Sound	External Static Pressure	Pa	80
	Pressure Level C/H	dB(A)	68.5/72.5
Unit(s)	Power Level C/H	dB(A)	91.5/95
	Height x Width x Depth	mm	1690 x 4920 x 780
Pipe Connections	Weight	kg	1296
	Refrigerant Base Charge	kg	9 x3 + 6
Maximum	Suction Gas Pipe Brazing	inch	2 1/8
	Liquid Pipe Flare	inch	7/8
Electrical	Equivalent Length	m	200
	Real Length	m	160
	Total Pipe Length (Liquid Line Real Length)	m	1200
	Length To First Branch	m	100
	Equivalent Length Of Outdoor Unit Connecting Pipe	m	10
	Real Length Of Indoor Unit Connecting Piping	m	30
	Equivalent Length Between Branches	m	50
	Height Difference Outdoor Higher Than Indoor Units	m	70 (110*)
	Height Difference Outdoor Lower Than Indoor Units	m	40 (110*)
	Height Difference Between Indoor Units	m	40
Electrical	Height Difference Between Outdoor Units	m	5
	Voltage Range Minimum/Maximum	V	342/456
	Electrical Characteristic Running Current Cooling/Heating	A	127.30/99.40
	Power Supply Wiring Starting Current	A	Soft Start
	Power Supply	V/ph/Hz	380-415/3/50
	Suggested Fused Supply(s)	A	63 x 3 + 32

\*Combination combined value, see stand alone for individual data

\*All [Accessories](#) / [Controls](#)

Related items:

- [Full specification](#)
- [CAD files](#)
- [Dimensional drawing](#)
- [Connection diagram](#)
- [Noise curve data](#)

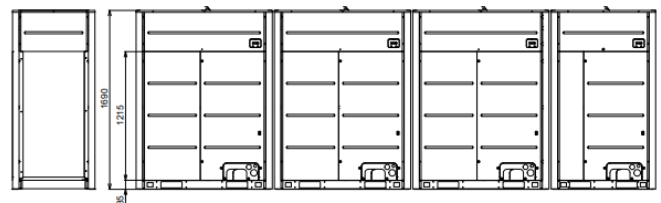

\*For further information see stand alone data

## VRF SMMSu R410a: **UP8611HT8P-E**

### COMBINATIONS

- Operating conditions from -25°C to +52°C.
- Up to 128 indoor units connected per system.
- Possibility to combine up to 5 outdoor units to achieve 120HP.
- Unique Triple Rotary Compressor and a totally redesigned chassis.
- Up to 1,200m total piping length with 250m from outdoor to the farthest indoor unit.



**SMMSu**  
SUPER MODULAR MULTI SYSTEM



Hi - Res Image

### Performance & Outdoor Data

Model & Combination		<b>UP8611HT8P-E</b> MUP2401HT8P-E x 3 MUP1401HT8P-E		
Capacity Range		HP	86	
Maximum Number of Indoor Units		QTY	96	
Cooling Capacity		kW	241.0	
Heating Capacity		kW	241.0	
Operating Range	Cooling	°C	-5.0 to 52.0	
	Heating		-25.0 to 15.5	
Cooling	Power Consumption	kW	87.12	
	EER/SEER/Energy Efficiency Class (or nsc %)		2.77/6.91/273.4	
Heating	Power Consumption	kW	66.94	
	COP/SCOP/Energy Efficiency Class (or nsc(A) %)		3.60/4.25/167.0	
Fan(s)	Standard Air Flow H	l/s	17049*	
	Standard Air Flow H	m <sup>3</sup> /h	61380*	
	External Static Pressure	Pa	80	
Sound	Pressure Level C/H	dB(A)	68.5/72.5	
	Power Level C/H	dB(A)	91.5/95	
Unit(s)	Height x Width x Depth	mm	1690 x 4920 x 780	
	Weight	kg	1296	
Pipe Connections	Refrigerant Base Charge	kg	9 x 3 + 6	
	Suction Gas Pipe Brazing	inch	2 1/8	
	Liquid Pipe Flare	inch	7/8	
	Equivalent Length	m	200	
	Real Length	m	160	
	Total Pipe Length (Liquid Line Real Length)	m	1200	
	Length To First Branch	m	100	
Maximum	Equivalent Length Of Outdoor Unit Connecting Pipe	m	10	
	Real Length Of Indoor Unit Connecting Piping	m	30	
	Equivalent Length Between Branches	m	50	
	Height Difference Outdoor Higher Than Indoor Units	m	70 (110*)	
	Height Difference Outdoor Lower Than Indoor Units	m	40 (110*)	
	Height Difference Between Indoor Units	m	40	
	Height Difference Between Outdoor Units	m	5	
	Electrical	Voltage Range Minimum/Maximum	V	342/456
		Electrical Characteristic Running Current Cooling/Heating	A	133.90/102.80
		Power Supply Wiring Starting Current	A	Soft Start
Power Supply		V/ph/Hz	380-415/3/50	
Suggested Fused Supply(s)		A	63 x 3 + 40	

\*Combination combined value, see stand alone for individual data

\*All [Accessories](#) / [Controls](#)

Related items:

- [Full specification](#)
- [CAD files](#)
- [Dimensional drawing](#)
- [Connection diagram](#)
- [Noise curve data](#)

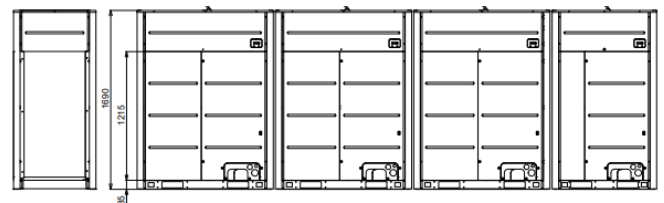

\*For further information see stand alone data

## VRF SMMSu R410a: **UP8811HT8P-E**

### COMBINATIONS

- Operating conditions from -25°C to +52°C.
- Up to 128 indoor units connected per system.
- Possibility to combine up to 5 outdoor units to achieve 120HP.
- Unique Triple Rotary Compressor and a totally redesigned chassis.
- Up to 1,200m total piping length with 250m from outdoor to the farthest indoor unit.



**SMMSu**  
SUPER MODULAR MULTI SYSTEM

Hi - Res Image

### Performance & Outdoor Data

Model & Combination		UP8811HT8P-E	
		MUP2401HT8P-E x 2 MUP2001HT8P-E x 2	
Capacity Range		HP	88
Maximum Number of Indoor Units		QTY	98
Cooling Capacity		kW	246.0
Heating Capacity		kW	246.0
Operating Range	Cooling	°C	-5.0 to 52.0
	Heating		-25.0 to 15.5
Cooling	Power Consumption	kW	84.40
	EER/SEER/Energy Efficiency Class (or nsc %)		2.91/7.21/285.4
Heating	Power Consumption	kW	67.82
	COP/SCOP/Energy Efficiency Class (or nsc(A) %)		3.63/4.30/169.0
Fan(s)	Standard Air Flow H	l/s	18000*
	Standard Air Flow H	m3/h	64800*
Sound	External Static Pressure	Pa	80
	Pressure Level C/H	dB(A)	69.5/73.5
Unit(s)	Power Level C/H	dB(A)	92.5/96.5
	Height x Width x Depth	mm	1690 x 5220 x 780
Pipe Connections	Weight	kg	1380
	Refrigerant Base Charge	kg	9 x4
Maximum	Suction Gas Pipe Brazing	inch	2 1/8
	Liquid Pipe Flare	inch	7/8
Electrical	Equivalent Length	m	200
	Real Length	m	160
	Total Pipe Length (Liquid Line Real Length)	m	1200
	Length To First Branch	m	100
	Equivalent Length Of Outdoor Unit Connecting Pipe	m	10
	Real Length Of Indoor Unit Connecting Piping	m	30
	Equivalent Length Between Branches	m	50
	Height Difference Outdoor Higher Than Indoor Units	m	70 (110*)
	Height Difference Outdoor Lower Than Indoor Units	m	40 (110*)
	Height Difference Between Indoor Units	m	40
Electrical	Height Difference Between Outdoor Units	m	5
	Voltage Range Minimum/Maximum	V	342/456
	Electrical Characteristic Running Current Cooling/Heating	A	129.60/104.00
	Power Supply Wiring Starting Current	A	Soft Start
	Power Supply	V/ph/Hz	380-415/3/50
	Suggested Fused Supply(s)	A	63 x 2 + 40 x 2

\*Combination combined value, see stand alone for individual data

\*All [Accessories](#) / [Controls](#)

Related items:

- [Full specification](#)
- [CAD files](#)
- [Dimensional drawing](#)
- [Connection diagram](#)
- [Noise curve data](#)

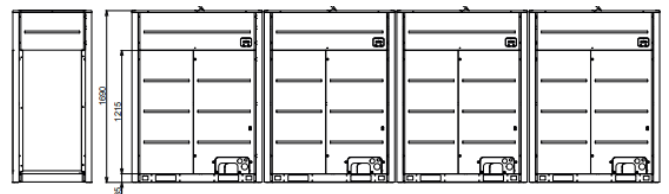

\*For further information see stand alone data

## VRF SMMSu R410a: **UP9011HT8P-E**

### COMBINATIONS

- Operating conditions from -25°C to +52°C.
- Up to 128 indoor units connected per system.
- Possibility to combine up to 5 outdoor units to achieve 120HP.
- Unique Triple Rotary Compressor and a totally redesigned chassis.
- Up to 1,200m total piping length with 250m from outdoor to the farthest indoor unit.



**SMMSu**  
SUPER MODULAR MULTI SYSTEM



Hi - Res Image

### Performance & Outdoor Data

Model & Combination		UP9011HT8P-E MUP2401HT8P-E x 2 MUP2201HT8P-E MUP2001HT8P-E	
Capacity Range		HP	90
Maximum Number of Indoor Units		QTY	100
Cooling Capacity		kW	251.5
Heating Capacity		kW	251.5
Operating Range	Cooling	°C	-5.0 to 52.0
	Heating		-25.0 to 15.5
Cooling	Power Consumption	kW	86.82
	EER/SEER/Energy Efficiency Class (or nsc %)		2.90/7.12/281.8
Heating	Power Consumption	kW	69.07
	COP/SCOP/Energy Efficiency Class (or nsc(A) %)		3.64/4.30/169.0
Fan(s)	Standard Air Flow H	l/s	18166*
	Standard Air Flow H	m3/h	65400*
	External Static Pressure	Pa	80
Sound	Pressure Level C/H	dB(A)	69.5/73.5
	Power Level C/H	dB(A)	92.5/96.5
Unit(s)	Height x Width x Depth	mm	1690 x 5220 x 780
	Weight	kg	1402
Pipe Connections	Refrigerant Base Charge	kg	9 x 4
	Suction Gas Pipe Brazing	inch	2 1/8
	Liquid Pipe Flare	inch	7/8
	Equivalent Length	m	200
	Real Length	m	160
	Total Pipe Length (Liquid Line Real Length)	m	1200
	Length To First Branch	m	100
	Equivalent Length Of Outdoor Unit Connecting Pipe	m	10
Maximum	Real Length Of Indoor Unit Connecting Piping	m	30
	Equivalent Length Between Branches	m	50
	Height Difference Outdoor Higher Than Indoor Units	m	70 (110*)
	Height Difference Outdoor Lower Than Indoor Units	m	40 (110*)
	Height Difference Between Indoor Units	m	40
	Height Difference Between Outdoor Units	m	5
Electrical	Voltage Range Minimum/Maximum	V	342/456
	Electrical Characteristic Running Current Cooling/Heating	A	133.30/105.90
	Power Supply Wiring Starting Current	A	Soft Start
	Power Supply	V/ph/Hz	380-415/3/50
	Suggested Fused Supply(s)	A	63 x 2 + 50 + 40

\*Combination combined value, see stand alone for individual data

\*All [Accessories / Controls](#)

Related items:

- [Full specification](#)
- [CAD files](#)
- [Dimensional drawing](#)
- [Connection diagram](#)
- [Noise curve data](#)

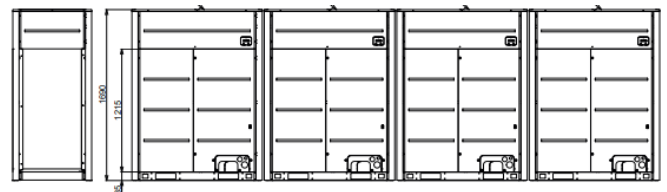

\*For further information see stand alone data

## VRF SMMSu R410a: UP9211HT8P-E

### COMBINATIONS

- Operating conditions from -25°C to +52°C.
- Up to 128 indoor units connected per system.
- Possibility to combine up to 5 outdoor units to achieve 120HP.
- Unique Triple Rotary Compressor and a totally redesigned chassis.
- Up to 1,200m total piping length with 250m from outdoor to the farthest indoor unit.



**SMMSu**  
SUPER MODULAR MULTI SYSTEM

Hi - Res Image

### Performance & Outdoor Data

Model & Combination		UP9211HT8P-E MUP2401HT8P-E x 3 MUP2001HT8P-E	
Capacity Range		HP	92
Maximum Number of Indoor Units		QTY	102
Cooling Capacity		kW	257.0
Heating Capacity		kW	257.0
Operating Range	Cooling	°C	-5.0 to 52.0
	Heating		-25.0 to 15.5
Cooling	Power Consumption	kW	90.58
	EER/SEER/Energy Efficiency Class (or nsc %)		2.84/7.03/278.2
Heating	Power Consumption	kW	71.87
	COP/SCOP/Energy Efficiency Class (or nsc(A) %)		3.58/4.24/166.6
Fan(s)	Standard Air Flow H	l/s	18166*
	Standard Air Flow H	m3/h	65400*
Sound	External Static Pressure	Pa	80
	Pressure Level C/H	dB(A)	69.5/73.5
Unit(s)	Power Level C/H	dB(A)	92.5/96.5
	Height x Width x Depth	mm	1690 x 5220 x 780
Pipe Connections	Weight	kg	1402
	Refrigerant Base Charge	kg	9 x4
Maximum	Suction Gas Pipe Brazing	inch	2 1/8
	Liquid Pipe Flare	inch	7/8
Electrical	Equivalent Length	m	200
	Real Length	m	160
	Total Pipe Length (Liquid Line Real Length)	m	1200
	Length To First Branch	m	100
	Equivalent Length Of Outdoor Unit Connecting Pipe	m	10
	Real Length Of Indoor Unit Connecting Piping	m	30
	Equivalent Length Between Branches	m	50
	Height Difference Outdoor Higher Than Indoor Units	m	70 (110*)
	Height Difference Outdoor Lower Than Indoor Units	m	40 (110*)
	Height Difference Between Indoor Units	m	40
Electrical	Height Difference Between Outdoor Units	m	5
	Voltage Range Minimum/Maximum	V	342/456
	Electrical Characteristic Running Current Cooling/Heating	A	139.00/110.20
	Power Supply Wiring Starting Current	A	Soft Start
	Power Supply	V/ph/Hz	380-415/3/50
	Suggested Fused Supply(s)	A	63 x 3 + 40

\*Combination combined value, see stand alone for individual data

\*All [Accessories](#) / [Controls](#)

Related items:

- [Full specification](#)
- [CAD files](#)
- [Dimensional drawing](#)
- [Connection diagram](#)
- [Noise curve data](#)

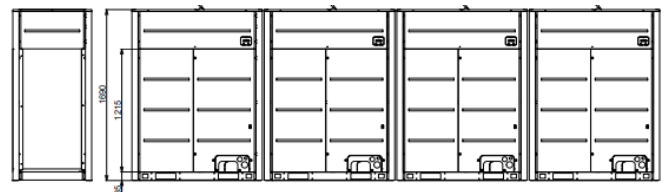

\*For further information see stand alone data

## VRF SMMSu R410a: UP9411HT8P-E

### COMBINATIONS

- Operating conditions from -25°C to +52°C.
- Up to 128 indoor units connected per system.
- Possibility to combine up to 5 outdoor units to achieve 120HP.
- Unique Triple Rotary Compressor and a totally redesigned chassis.
- Up to 1,200m total piping length with 250m from outdoor to the farthest indoor unit.



**SMMSu**  
SUPER MODULAR MULTI SYSTEM



Hi - Res Image

### Performance & Outdoor Data

Model & Combination		UP9411HT8P-E MUP2401HT8P-E x 3 MUP2201HT8P-E	
Capacity Range		HP	94
Maximum Number of Indoor Units		QTY	104
Cooling Capacity		kW	262.5
Heating Capacity		kW	262.5
Operating Range	Cooling	°C	-5.0 to 52.0
	Heating		-25.0 to 15.5
Cooling	Power Consumption	kW	93.00
	EER/SEER/Energy Efficiency Class (or nsc %)		2.82/6.95/275.0
Heating	Power Consumption	kW	73.12
	COP/SCOP/Energy Efficiency Class (or nsc(A) %)		3.59/4.24/166.6
Fan(s)	Standard Air Flow H	l/s	18332*
	Standard Air Flow H	m3/h	66000*
	External Static Pressure	Pa	80
Sound	Pressure Level C/H	dB(A)	69.5/73.5
	Power Level C/H	dB(A)	92.5/96.5
Unit(s)	Height x Width x Depth	mm	1690 x 5220 x 780
	Weight	kg	1424
Pipe Connections	Refrigerant Base Charge	kg	9 x4
	Suction Gas Pipe Brazing	inch	2 1/8
	Liquid Pipe Flare	inch	7/8
Maximum	Equivalent Length	m	200
	Real Length	m	160
	Total Pipe Length (Liquid Line Real Length)	m	1200
	Length To First Branch	m	100
	Equivalent Length Of Outdoor Unit Connecting Pipe	m	10
	Real Length Of Indoor Unit Connecting Piping	m	30
	Equivalent Length Between Branches	m	50
	Height Difference Outdoor Higher Than Indoor Units	m	70 (110*)
	Height Difference Outdoor Lower Than Indoor Units	m	40 (110*)
	Height Difference Between Indoor Units	m	40
Height Difference Between Outdoor Units	m	5	
Electrical	Voltage Range Minimum/Maximum	V	342/456
	Electrical Characteristic Running Current Cooling/Heating	A	142.70/112.10
	Power Supply Wiring Starting Current	A	Soft Start
	Power Supply	V/ph/Hz	380-415/3/50
	Suggested Fused Supply(s)	A	63 x 3 + 50

\*Combination combined value, see stand alone for individual data

\*All [Accessories](#) / [Controls](#)

Related items:

- [Full specification](#)
- [CAD files](#)
- [Dimensional drawing](#)
- [Connection diagram](#)
- [Noise curve data](#)

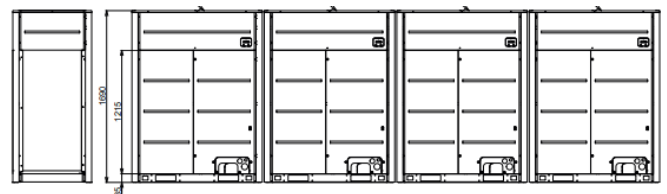

\*For further information see stand alone data



## VRF SMMSu R410a: **UP9611HT8P-E**

### COMBINATIONS

- Operating conditions from -25°C to +52°C.
- Up to 128 indoor units connected per system.
- Possibility to combine up to 5 outdoor units to achieve 120HP.
- Unique Triple Rotary Compressor and a totally redesigned chassis.
- Up to 1,200m total piping length with 250m from outdoor to the farthest indoor unit.



**SMMSu**  
SUPER MODULAR MULTI SYSTEM



Hi - Res Image

### Performance & Outdoor Data

Model & Combination		UP9611HT8P-E MUP2401HT8P-E x 4		
Capacity Range		HP	96	
Maximum Number of Indoor Units		QTY	106	
Cooling Capacity		kW	268.0	
Heating Capacity		kW	268.0	
Operating Range	Cooling	°C	-5.0 to 52.0	
	Heating		-25.0 to 15.5	
Cooling	Power Consumption	kW	96.76	
	EER/SEER/Energy Efficiency Class (or nsc %)		2.77/6.87/271.8	
Heating	Power Consumption	kW	75.92	
	COP/SCOP/Energy Efficiency Class (or nsc(A) %)		3.53/4.17/163.8	
Fan(s)	Standard Air Flow H	l/s	18332*	
	Standard Air Flow H	m3/h	66000*	
	External Static Pressure	Pa	80	
Sound	Pressure Level C/H	dB(A)	69.5/73.5	
	Power Level C/H	dB(A)	92.5/96.5	
Unit(s)	Height x Width x Depth	mm	1690 x 5220 x 780	
	Weight	kg	1424	
Pipe Connections	Refrigerant Base Charge	kg	9 x4	
	Suction Gas Pipe Brazing	inch	2 1/8	
	Liquid Pipe Flare	inch	7/8	
Maximum	Equivalent Length	m	200	
	Real Length	m	160	
	Total Pipe Length (Liquid Line Real Length)	m	1200	
	Length To First Branch	m	100	
	Equivalent Length Of Outdoor Unit Connecting Pipe	m	10	
	Real Length Of Indoor Unit Connecting Piping	m	30	
	Equivalent Length Between Branches	m	50	
	Height Difference Outdoor Higher Than Indoor Units	m	70 (110*)	
	Height Difference Outdoor Lower Than Indoor Units	m	40 (110*)	
	Height Difference Between Indoor Units	m	40	
	Height Difference Between Outdoor Units	m	5	
	Electrical	Voltage Range Minimum/Maximum	V	342/456
		Electrical Characteristic Running Current Cooling/Heating	A	148.40/116.40
Power Supply Wiring Starting Current		A	Soft Start	
Power Supply		V/ph/Hz	380-415/3/50	
Suggested Fused Supply(s)		A	63 x 4	

\*Combination combined value, see stand alone for individual data

\*All [Accessories](#) / [Controls](#)

Related items:

- [Full specification](#)
- [CAD files](#)
- [Dimensional drawing](#)
- [Connection diagram](#)
- [Noise curve data](#)

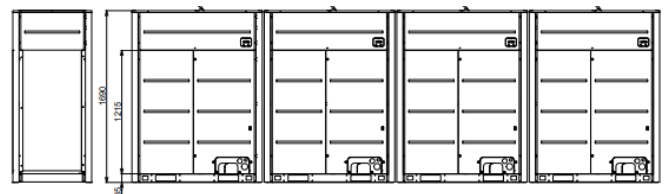

\*For further information see stand alone data

## VRF SMMSu R410a: UP9811HT8P-E

### COMBINATIONS

- Operating conditions from -25°C to +52°C.
- Up to 128 indoor units connected per system.
- Possibility to combine up to 5 outdoor units to achieve 120HP.
- Unique Triple Rotary Compressor and a totally redesigned chassis.
- Up to 1,200m total piping length with 250m from outdoor to the farthest indoor unit.



**SMMSu**  
SUPER MODULAR MULTI SYSTEM



Hi - Res Image

### Performance & Outdoor Data

Model & Combination		UP9811HT8P-E	
Capacity Range		HP	98
Maximum Number of Indoor Units		QTY	108
Cooling Capacity		kW	274.5
Heating Capacity		kW	274.5
Operating Range	Cooling	°C	-5.0 to 52.0
	Heating		-25.0 to 15.5
Cooling	Power Consumption	kW	97.46
	EER/SEER/Energy Efficiency Class (or nsc %)		2.82/6.95/275.0
Heating	Power Consumption	kW	74.71
	COP/SCOP/Energy Efficiency Class (or nsc(A) %)		3.67/4.31/169.4
Fan(s)	Standard Air Flow H	l/s	20299*
	Standard Air Flow H	m3/h	73080*
Sound	External Static Pressure	Pa	80
	Pressure Level C/H	dB(A)	69/73
	Power Level C/H	dB(A)	91.5/95.5
Unit(s)	Height x Width x Depth	mm	1690 x 5930 x 780
	Weight	kg	1524
Pipe Connections	Refrigerant Base Charge	kg	9 x 3 + 6 x 2
	Suction Gas Pipe Brazing	inch	2 1/8
	Liquid Pipe Flare	inch	7/8
Maximum	Equivalent Length	m	200
	Real Length	m	160
	Total Pipe Length (Liquid Line Real Length)	m	1200
	Length To First Branch	m	100
	Equivalent Length Of Outdoor Unit Connecting Pipe	m	10
	Real Length Of Indoor Unit Connecting Piping	m	30
	Equivalent Length Between Branches	m	50
	Height Difference Outdoor Higher Than Indoor Units	m	70 (110*)
	Height Difference Outdoor Lower Than Indoor Units	m	40 (110*)
	Height Difference Between Indoor Units	m	40
	Height Difference Between Outdoor Units	m	5
Electrical	Voltage Range Minimum/Maximum	V	342/456
	Electrical Characteristic Running Current Cooling/Heating	A	149.90/114.90
	Power Supply Wiring Starting Current	A	Soft Start
	Power Supply	V/ph/Hz	380-415/3/50
	Suggested Fused Supply(s)	A	63 x 3 + 40 + 32

\*Combination combined value, see stand alone for individual data

\*All [Accessories / Controls](#)

Related items:

- [Full specification](#)
- [CAD files](#)
- [Dimensional drawing](#)
- [Connection diagram](#)
- [Noise curve data](#)

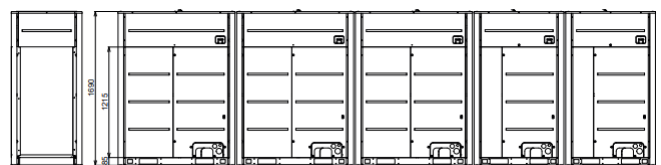

\*For further information see stand alone data

## VRF SMMSu R410a: **UP10011HT8P-E**

### COMBINATIONS

- Operating conditions from -25°C to +52°C.
- Up to 128 indoor units connected per system.
- Possibility to combine up to 5 outdoor units to achieve 120HP.
- Unique Triple Rotary Compressor and a totally redesigned chassis.
- Up to 1,200m total piping length with 250m from outdoor to the farthest indoor unit.



**SMMSu**  
SUPER MODULAR MULTI SYSTEM

Hi - Res Image

### Performance & Outdoor Data

Model & Combination		<b>UP10011HT8P-E</b>	
		MUP2401HT8P-E x 3 MUP1401HT8P-E x 2	
Capacity Range		HP	100
Maximum Number of Indoor Units		QTY	110
Cooling Capacity		kW	281.0
Heating Capacity		kW	281.0
Operating Range	Cooling	°C	-5.0 to 52.0
	Heating		-25.0 to 15.5
Cooling	Power Consumption	kW	101.67
	EER/SEER/Energy Efficiency Class (or nsc %)		2.76/6.94/274.6
Heating	Power Consumption	kW	76.94
	COP/SCOP/Energy Efficiency Class (or nsc(A) %)		3.65/4.30/169.0
Fan(s)	Standard Air Flow H	l/s	20349*
	Standard Air Flow H	m3/h	73260*
	External Static Pressure	Pa	80
Sound	Pressure Level C/H	dB(A)	69/73
	Power Level C/H	dB(A)	91.5/95.5
Unit(s)	Height x Width x Depth	mm	1690 x 5930 x 780
	Weight	kg	1524
Pipe Connections	Refrigerant Base Charge	kg	9 x3 + 6 x2
	Suction Gas Pipe Brazing	inch	2 1/8
	Liquid Pipe Flare	inch	7/8
Maximum	Equivalent Length	m	200
	Real Length	m	160
	Total Pipe Length (Liquid Line Real Length)	m	1200
	Length To First Branch	m	100
	Equivalent Length Of Outdoor Unit Connecting Pipe	m	10
	Real Length Of Indoor Unit Connecting Piping	m	30
	Equivalent Length Between Branches	m	50
	Height Difference Outdoor Higher Than Indoor Units	m	70 (110*)
	Height Difference Outdoor Lower Than Indoor Units	m	40 (110*)
	Height Difference Between Indoor Units	m	40
Electrical	Height Difference Between Outdoor Units	m	5
	Voltage Range Minimum/Maximum	V	342/456
	Electrical Characteristic Running Current Cooling/Heating	A	156.50/118.30
	Power Supply Wiring Starting Current	A	0
	Power Supply	V/ph/Hz	380-415/3/50
	Suggested Fused Supply(s)	A	63 x 3 + 40 x 2

\*Combination combined value, see stand alone for individual data

\*All [Accessories](#) / [Controls](#)

Related items:

- [Full specification](#)
- [CAD files](#)
- [Dimensional drawing](#)
- [Connection diagram](#)
- [Noise curve data](#)

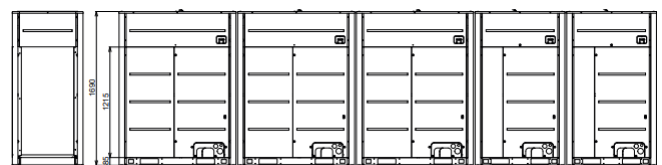

\*For further information see stand alone data

## VRF SMMSu R410a: UP10211HT8P-E

### COMBINATIONS

- Operating conditions from -25°C to +52°C.
- Up to 128 indoor units connected per system.
- Possibility to combine up to 5 outdoor units to achieve 120HP.
- Unique Triple Rotary Compressor and a totally redesigned chassis.
- Up to 1,200m total piping length with 250m from outdoor to the farthest indoor unit.



**SMMSu**  
SUPER MODULAR MULTI SYSTEM



Hi - Res Image

### Performance & Outdoor Data

Model & Combination		<b>UP10211HT8P-E</b>	
			MUP2401HT8P-E x 2 MUP2001HT8P-E x 2 MUP1401HT8P-E
Capacity Range		HP	102
Maximum Number of Indoor Units		QTY	112
Cooling Capacity		kW	286.0
Heating Capacity		kW	286.0
Operating Range	Cooling	°C	-5.0 to 52.0
	Heating		-25.0 to 15.5
Cooling	Power Consumption	kW	98.95
	EER/SEER/Energy Efficiency Class (or nsc %)		2.89/7.20/285.0
Heating	Power Consumption	kW	77.82
	COP/SCOP/Energy Efficiency Class (or nsc(A) %)		3.68/4.34/170.6
Fan(s)	Standard Air Flow H	l/s	21300*
	Standard Air Flow H	m3/h	76680*
	External Static Pressure	Pa	80
Sound	Pressure Level C/H	dB(A)	69.5/73.5
	Power Level C/H	dB(A)	92.5/96.5
Unit(s)	Height x Width x Depth	mm	1690 x 6230 x 780
	Weight	kg	1608
	Refrigerant Base Charge	kg	9 x4 + 6
Pipe Connections	Suction Gas Pipe Brazing	inch	2 1/8
	Liquid Pipe Flare	inch	7/8
Maximum	Equivalent Length	m	200
	Real Length	m	160
	Total Pipe Length (Liquid Line Real Length)	m	1200
	Length To First Branch	m	100
	Equivalent Length Of Outdoor Unit Connecting Pipe	m	10
	Real Length Of Indoor Unit Connecting Piping	m	30
	Equivalent Length Between Branches	m	50
	Height Difference Outdoor Higher Than Indoor Units	m	70 (110*)
	Height Difference Outdoor Lower Than Indoor Units	m	40 (110*)
	Height Difference Between Indoor Units	m	40
	Height Difference Between Outdoor Units	m	5
	Electrical	Voltage Range Minimum/Maximum	V
Electrical Characteristic Running Current Cooling/Heating		A	152.20/119.50
Power Supply Wiring Starting Current		A	Soft Start
Power Supply		V/ph/Hz	380-415/3/50
Suggested Fused Supply(s)		A	63 x 2 + 40 x 3

\*Combination combined value, see stand alone for individual data

\*All [Accessories](#) / [Controls](#)

Related items:

- [Full specification](#)
- [CAD files](#)
- [Dimensional drawing](#)
- [Connection diagram](#)
- [Noise curve data](#)

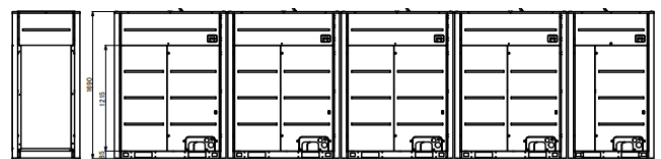

\*For further information see stand alone data

## VRF SMMSu R410a: UP10411HT8P-E

### COMBINATIONS

- Operating conditions from -25°C to +52°C.
- Up to 128 indoor units connected per system.
- Possibility to combine up to 5 outdoor units to achieve 120HP.
- Unique Triple Rotary Compressor and a totally redesigned chassis.
- Up to 1,200m total piping length with 250m from outdoor to the farthest indoor unit.



**SMMSu**  
SUPER MODULAR MULTI SYSTEM



Hi - Res Image

### Performance & Outdoor Data

Model & Combination		UP10411HT8P-E MUP2401HT8P-E x 3 MUP2001HT8P-E MUP1201HT8P-E	
Capacity Range		HP	104
Maximum Number of Indoor Units		QTY	114
Cooling Capacity		kW	290.5
Heating Capacity		kW	290.5
Operating Range	Cooling	°C	-5.0 to 52.0
	Heating		-25.0 to 15.5
Cooling	Power Consumption	kW	100.92
	EER/SEER/Energy Efficiency Class (or nsc %)		2.88/7.08/280.2
Heating	Power Consumption	kW	79.64
	COP/SCOP/Energy Efficiency Class (or nsc(A) %)		3.65/4.30/169.0
Fan(s)	Standard Air Flow H	l/s	21416*
	Standard Air Flow H	m3/h	77100*
Sound	External Static Pressure	Pa	80
	Pressure Level C/H	dB(A)	69.5/73.5
	Power Level C/H	dB(A)	92.5/96.5
Unit(s)	Height x Width x Depth	mm	1690 x 6230 x 780
	Weight	kg	1630
Pipe Connections	Refrigerant Base Charge	kg	9 x4 + 6
	Suction Gas Pipe Brazing	inch	2 1/8
	Liquid Pipe Flare	inch	7/8
Maximum	Equivalent Length	m	200
	Real Length	m	160
	Total Pipe Length (Liquid Line Real Length)	m	1200
	Length To First Branch	m	100
	Equivalent Length Of Outdoor Unit Connecting Pipe	m	10
	Real Length Of Indoor Unit Connecting Piping	m	30
	Equivalent Length Between Branches	m	50
	Height Difference Outdoor Higher Than Indoor Units	m	70 (110*)
	Height Difference Outdoor Lower Than Indoor Units	m	40 (110*)
	Height Difference Between Indoor Units	m	40
	Height Difference Between Outdoor Units	m	5
Electrical	Voltage Range Minimum/Maximum	V	342/456
	Electrical Characteristic Running Current Cooling/Heating	A	155.00/122.30
	Power Supply Wiring Starting Current	A	Soft Start
	Power Supply	V/ph/Hz	380-415/3/50
	Suggested Fused Supply(s)	A	63 x 3 + 40 + 32

\*Combination combined value, see stand alone for individual data

\*All [Accessories](#) / [Controls](#)

Related items:

- [Full specification](#)
- [CAD files](#)
- [Dimensional drawing](#)
- [Connection diagram](#)
- [Noise curve data](#)

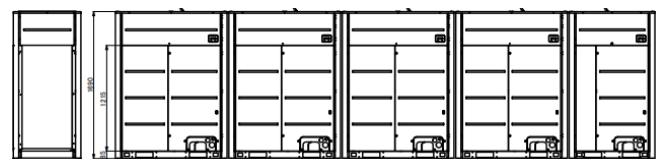

\*For further information see stand alone data

## VRF SMMSu R410a: **UP10611HT8P-E**

### COMBINATIONS

- Operating conditions from -25°C to +52°C.
- Up to 128 indoor units connected per system.
- Possibility to combine up to 5 outdoor units to achieve 120HP.
- Unique Triple Rotary Compressor and a totally redesigned chassis.
- Up to 1,200m total piping length with 250m from outdoor to the farthest indoor unit.



**SMMSu**  
SUPER MODULAR MULTI SYSTEM



Hi - Res Image

### Performance & Outdoor Data

Model & Combination		<b>UP10611HT8P-E</b>	
Capacity Range		HP	106
Maximum Number of Indoor Units		QTY	116
Cooling Capacity		kW	297.0
Heating Capacity		kW	297.0
Operating Range	Cooling	°C	-5.0 to 52.0
	Heating		-25.0 to 15.5
Cooling	Power Consumption	kW	105.13
	EER/SEER/Energy Efficiency Class (or nsc %)		2.83/7.04/278.6
Heating	Power Consumption	kW	81.87
	COP/SCOP/Energy Efficiency Class (or nsc(A) %)		3.63/4.29/168.6
Fan(s)	Standard Air Flow H	l/s	21466*
	Standard Air Flow H	m <sup>3</sup> /h	77280*
	External Static Pressure	Pa	80
Sound	Pressure Level C/H	dB(A)	69.5/73.5
	Power Level C/H	dB(A)	92.5/96.5
Unit(s)	Height x Width x Depth	mm	1690 x 6230 x 780
	Weight	kg	1630
Pipe Connections	Refrigerant Base Charge	kg	9 x4 + 6
	Suction Gas Pipe Brazing	inch	2 1/8
Maximum	Liquid Pipe Flare	inch	7/8
	Equivalent Length	m	200
	Real Length	m	160
	Total Pipe Length (Liquid Line Real Length)	m	1200
	Length To First Branch	m	100
	Equivalent Length Of Outdoor Unit Connecting Pipe	m	10
	Real Length Of Indoor Unit Connecting Piping	m	30
	Equivalent Length Between Branches	m	50
	Height Difference Outdoor Higher Than Indoor Units	m	70 (110*)
	Height Difference Outdoor Lower Than Indoor Units	m	40 (110*)
Electrical	Height Difference Between Indoor Units	m	40
	Height Difference Between Outdoor Units	m	5
	Voltage Range Minimum/Maximum	V	342/456
	Electrical Characteristic Running Current Cooling/Heating	A	161.60/125.70
	Power Supply Wiring Starting Current	A	Soft Start
Electrical	Power Supply	V/ph/Hz	380-415/3/50
	Suggested Fused Supply(s)	A	63 x 3 + 40 x 2

\*Combination combined value, see stand alone for individual data

\*All [Accessories](#) / [Controls](#)

Related items:

- [Full specification](#)
- [CAD files](#)
- [Dimensional drawing](#)
- [Connection diagram](#)
- [Noise curve data](#)

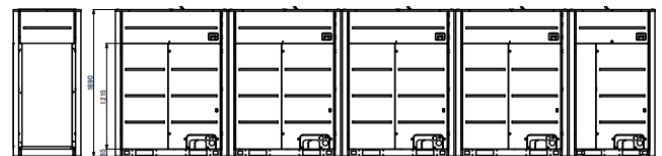

\*For further information see stand alone data

## VRF SMMSu R410a: UP10811HT8P-E

### COMBINATIONS

- Operating conditions from -25°C to +52°C.
- Up to 128 indoor units connected per system.
- Possibility to combine up to 5 outdoor units to achieve 120HP.
- Unique Triple Rotary Compressor and a totally redesigned chassis.
- Up to 1,200m total piping length with 250m from outdoor to the farthest indoor unit.



**SMMSu**  
SUPER MODULAR MULTI SYSTEM



Hi - Res Image

### Performance & Outdoor Data

Model & Combination		UP10811HT8P-E MUP2401HT8P-E x 4 MUP1201HT8P-E	
Capacity Range		HP	108
Maximum Number of Indoor Units		QTY	118
Cooling Capacity		kW	301.5
Heating Capacity		kW	301.5
Operating Range	Cooling	°C	-5.0 to 52.0
	Heating		-25.0 to 15.5
Cooling	Power Consumption	kW	107.10
	EER/SEER/Energy Efficiency Class (or nsc %)		2.82/6.93/274.2
Heating	Power Consumption	kW	83.69
	COP/SCOP/Energy Efficiency Class (or nsc(A) %)		3.60/4.24/166.6
Fan(s)	Standard Air Flow H	l/s	21582*
	Standard Air Flow H	m3/h	77700*
	External Static Pressure	Pa	80
Sound	Pressure Level C/H	dB(A)	69.5/73.5
	Power Level C/H	dB(A)	92.5/96.5
Unit(s)	Height x Width x Depth	mm	1690 x 6230 x 780
	Weight	kg	1652
Pipe Connections	Refrigerant Base Charge	kg	9 x4 + 6
	Suction Gas Pipe Brazing	inch	2 1/8
	Liquid Pipe Flare	inch	7/8
	Equivalent Length	m	200
	Real Length	m	160
	Total Pipe Length (Liquid Line Real Length)	m	1200
	Length To First Branch	m	100
	Equivalent Length Of Outdoor Unit Connecting Pipe	m	10
	Real Length Of Indoor Unit Connecting Piping	m	30
	Equivalent Length Between Branches	m	50
Maximum	Height Difference Outdoor Higher Than Indoor Units	m	70 (110*)
	Height Difference Outdoor Lower Than Indoor Units	m	40 (110*)
	Height Difference Between Indoor Units	m	40
	Height Difference Between Outdoor Units	m	5
	Electrical	Voltage Range Minimum/Maximum	V
	Electrical Characteristic Running Current Cooling/Heating	A	164.40/128.50
	Power Supply Wiring Starting Current	A	Soft Start
	Power Supply	V/ph/Hz	380-415/3/50
	Suggested Fused Supply(s)	A	63 x 4 + 32

\*Combination combined value, see stand alone for individual data

\*All [Accessories](#) / [Controls](#)

Related items:

- [Full specification](#)
- [CAD files](#)
- [Dimensional drawing](#)
- [Connection diagram](#)
- [Noise curve data](#)

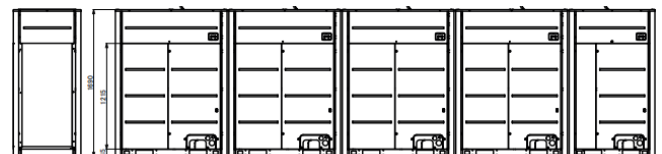

\*For further information see stand alone data

## VRF SMMSu R410a: UP11011HT8P-E

### COMBINATIONS

- Operating conditions from -25°C to +52°C.
- Up to 128 indoor units connected per system.
- Possibility to combine up to 5 outdoor units to achieve 120HP.
- Unique Triple Rotary Compressor and a totally redesigned chassis.
- Up to 1,200m total piping length with 250m from outdoor to the farthest indoor unit.



**SMMSu**  
SUPER MODULAR MULTI SYSTEM



Hi - Res Image

### Performance & Outdoor Data

Model & Combination		UP11011HT8P-E MUP2401HT8P-E x 4 MUP1401HT8P-E		
Capacity Range		HP	110	
Maximum Number of Indoor Units		QTY	120	
Cooling Capacity		kW	308.0	
Heating Capacity		kW	308.0	
Operating Range	Cooling	°C	-5.0 to 52.0	
	Heating		-25.0 to 15.5	
Cooling	Power Consumption	kW	111.31	
	EER/SEER/Energy Efficiency Class (or nsc %)		2.77/6.90/273.0	
Heating	Power Consumption	kW	85.92	
	COP/SCOP/Energy Efficiency Class (or nsc(A) %)		3.58/4.23/166.2	
Fan(s)	Standard Air Flow H	l/s	21632*	
	Standard Air Flow H	m3/h	77880*	
	External Static Pressure	Pa	80	
Sound	Pressure Level C/H	dB(A)	69.5/73.5	
	Power Level C/H	dB(A)	92.5/96.5	
Unit(s)	Height x Width x Depth	mm	1690 x 6230 x 780	
	Weight	kg	1652	
Pipe Connections	Refrigerant Base Charge	kg	9 x4 + 6	
	Suction Gas Pipe Brazing	inch	2 1/8	
	Liquid Pipe Flare	inch	7/8	
	Equivalent Length	m	200	
	Real Length	m	160	
	Total Pipe Length (Liquid Line Real Length)	m	1200	
	Length To First Branch	m	100	
	Equivalent Length Of Outdoor Unit Connecting Pipe	m	10	
	Real Length Of Indoor Unit Connecting Piping	m	30	
	Equivalent Length Between Branches	m	50	
Maximum	Height Difference Outdoor Higher Than Indoor Units	m	70 (110*)	
	Height Difference Outdoor Lower Than Indoor Units	m	40 (110*)	
	Height Difference Between Indoor Units	m	40	
	Height Difference Between Outdoor Units	m	5	
	Electrical	Voltage Range Minimum/Maximum	V	342/456
		Electrical Characteristic Running Current Cooling/Heating	A	171.00/131.90
Power Supply Wiring Starting Current		A	Soft Start	
Power Supply		V/ph/Hz	380-415/3/50	
Suggested Fused Supply(s)		A	63 x 4 + 40	

\*Combination combined value, see stand alone for individual data

\*All [Accessories](#) / [Controls](#)

Related items:

- [Full specification](#)
- [CAD files](#)
- [Dimensional drawing](#)
- [Connection diagram](#)
- [Noise curve data](#)

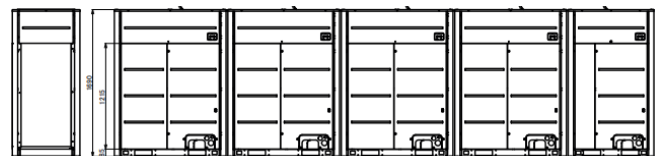

\*For further information see stand alone data



## VRF SMMSu R410a: UP11211HT8P-E

### COMBINATIONS

- Operating conditions from -25°C to +52°C.
- Up to 128 indoor units connected per system.
- Possibility to combine up to 5 outdoor units to achieve 120HP.
- Unique Triple Rotary Compressor and a totally redesigned chassis.
- Up to 1,200m total piping length with 250m from outdoor to the farthest indoor unit.



**SMMSu**  
SUPER MODULAR MULTI SYSTEM



Hi - Res Image

### Performance & Outdoor Data

Model & Combination		<b>UP11211HT8P-E</b>	
		MUP2401HT8P-E x 3 MUP2001HT8P-E x 2	
Capacity Range		HP	112
Maximum Number of Indoor Units		QTY	122
Cooling Capacity		kW	313.0
Heating Capacity		kW	313.0
Operating Range	Cooling	°C	-5.0 to 52.0
	Heating		-25.0 to 15.5
Cooling	Power Consumption	kW	108.59
	EER/SEER/Energy Efficiency Class (or nsc %)		2.88/7.13/282.2
Heating	Power Consumption	kW	86.80
	COP/SCOP/Energy Efficiency Class (or nsc(A) %)		3.61/4.28/168.2
Fan(s)	Standard Air Flow H	l/s	22583*
	Standard Air Flow H	m <sup>3</sup> /h	81300*
	External Static Pressure	Pa	80
Sound	Pressure Level C/H	dB(A)	70/74
	Power Level C/H	dB(A)	93/97
Unit(s)	Height x Width x Depth	mm	1690 x 6530 x 780
	Weight	kg	1736
Pipe Connections	Refrigerant Base Charge	kg	9 x5
	Suction Gas Pipe Brazing	inch	2 1/8
Maximum	Liquid Pipe Flare	inch	7/8
	Equivalent Length	m	200
	Real Length	m	160
	Total Pipe Length (Liquid Line Real Length)	m	1200
	Length To First Branch	m	100
	Equivalent Length Of Outdoor Unit Connecting Pipe	m	10
	Real Length Of Indoor Unit Connecting Piping	m	30
	Equivalent Length Between Branches	m	50
	Height Difference Outdoor Higher Than Indoor Units	m	70 (110*)
	Height Difference Outdoor Lower Than Indoor Units	m	40 (110*)
Electrical	Height Difference Between Indoor Units	m	40
	Height Difference Between Outdoor Units	m	5
	Voltage Range Minimum/Maximum	V	342/456
	Electrical Characteristic Running Current Cooling/Heating	A	166.70/133.10
	Power Supply Wiring Starting Current	A	Soft Start
Power Supply	V/ph/Hz	380-415/3/50	
Suggested Fused Supply(s)	A	63 x 3 + 40 x 2	

\*Combination combined value, see stand alone for individual data

\*All [Accessories](#) / [Controls](#)

Related items:

- [Full specification](#)
- [CAD files](#)
- [Dimensional drawing](#)
- [Connection diagram](#)
- [Noise curve data](#)

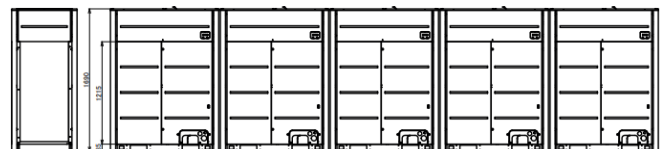

\*For further information see stand alone data

## VRF SMMSu R410a: UP11411HT8P-E

### COMBINATIONS

- Operating conditions from -25°C to +52°C.
- Up to 128 indoor units connected per system.
- Possibility to combine up to 5 outdoor units to achieve 120HP.
- Unique Triple Rotary Compressor and a totally redesigned chassis.
- Up to 1,200m total piping length with 250m from outdoor to the farthest indoor unit.



**SMMSu**  
SUPER MODULAR MULTI SYSTEM

Hi - Res Image

### Performance & Outdoor Data

Model & Combination		<b>UP11411HT8P-E</b> MUP2401HT8P-E x 3 MUP2201HT8P-E MUP2001HT8P-E	
Capacity Range		HP	114
Maximum Number of Indoor Units		QTY	124
Cooling Capacity		kW	318.5
Heating Capacity		kW	318.5
Operating Range	Cooling	°C	-5.0 to 52.0
	Heating		-25.0 to 15.5
Cooling	Power Consumption	kW	111.01
	EER/SEER/Energy Efficiency Class (or nsc %)		2.87/7.07/279.8
Heating	Power Consumption	kW	88.05
	COP/SCOP/Energy Efficiency Class (or nsc(A) %)		3.62/4.28/168.2
Fan(s)	Standard Air Flow H	l/s	22749*
	Standard Air Flow H	m <sup>3</sup> /h	81900*
Sound	External Static Pressure	Pa	80
	Pressure Level C/H	dB(A)	70/74
	Power Level C/H	dB(A)	93/97
Unit(s)	Height x Width x Depth	mm	1690 x 6530 x 780
	Weight	kg	1758
Pipe Connections	Refrigerant Base Charge	kg	9 x5
	Suction Gas Pipe Brazing	inch	2 1/8
	Liquid Pipe Flare	inch	7/8
Maximum	Equivalent Length	m	200
	Real Length	m	160
	Total Pipe Length (Liquid Line Real Length)	m	1200
	Length To First Branch	m	100
	Equivalent Length Of Outdoor Unit Connecting Pipe	m	10
	Real Length Of Indoor Unit Connecting Piping	m	30
	Equivalent Length Between Branches	m	50
	Height Difference Outdoor Higher Than Indoor Units	m	70 (110*)
	Height Difference Outdoor Lower Than Indoor Units	m	40 (110*)
	Height Difference Between Indoor Units	m	40
	Height Difference Between Outdoor Units	m	5
Electrical	Voltage Range Minimum/Maximum	V	342/456
	Electrical Characteristic Running Current Cooling/Heating	A	170.40/135.00
	Power Supply Wiring Starting Current	A	Soft Start
	Power Supply	V/ph/Hz	380-415/3/50
	Suggested Fused Supply(s)	A	63 x 3 + 50 + 40

\*Combination combined value, see stand alone for individual data

\*All [Accessories](#) / [Controls](#)

Related items:

- [Full specification](#)
- [CAD files](#)
- [Dimensional drawing](#)
- [Connection diagram](#)
- [Noise curve data](#)

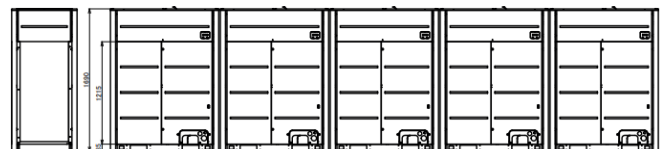

\*For further information see stand alone data

## VRF SMMSu R410a: UP11611HT8P-E

### COMBINATIONS

- Operating conditions from -25°C to +52°C.
- Up to 128 indoor units connected per system.
- Possibility to combine up to 5 outdoor units to achieve 120HP.
- Unique Triple Rotary Compressor and a totally redesigned chassis.
- Up to 1,200m total piping length with 250m from outdoor to the farthest indoor unit.



**SMMSu**  
SUPER MODULAR MULTI SYSTEM



Hi - Res Image

### Performance & Outdoor Data

Model & Combination		UP11611HT8P-E MUP2401HT8P-E x 4 MUP2001HT8P-E	
Capacity Range		HP	116
Maximum Number of Indoor Units		QTY	126
Cooling Capacity		kW	324.0
Heating Capacity		kW	324.0
Operating Range	Cooling	°C	-5.0 to 52.0
	Heating		-25.0 to 15.5
Cooling	Power Consumption	kW	114.77
	EER/SEER/Energy Efficiency Class (or nsc %)		2.82/7.00/277.0
Heating	Power Consumption	kW	90.85
	COP/SCOP/Energy Efficiency Class (or nsc(A) %)		3.57/4.22/165.8
Fan(s)	Standard Air Flow H	l/s	22749*
	Standard Air Flow H	m3/h	81900*
	External Static Pressure	Pa	80
Sound	Pressure Level C/H	dB(A)	70/74
	Power Level C/H	dB(A)	93/97
Unit(s)	Height x Width x Depth	mm	1690 x 6530 x 780
	Weight	kg	1758
Pipe Connections	Refrigerant Base Charge	kg	9 x 5
	Suction Gas Pipe Brazing	inch	2 1/8
	Liquid Pipe Flare	inch	7/8
Maximum	Equivalent Length	m	200
	Real Length	m	160
	Total Pipe Length (Liquid Line Real Length)	m	1200
	Length To First Branch	m	100
	Equivalent Length Of Outdoor Unit Connecting Pipe	m	10
	Real Length Of Indoor Unit Connecting Piping	m	30
	Equivalent Length Between Branches	m	50
	Height Difference Outdoor Higher Than Indoor Units	m	70 (110*)
	Height Difference Outdoor Lower Than Indoor Units	m	40 (110*)
	Height Difference Between Indoor Units	m	40
Electrical	Height Difference Between Outdoor Units	m	5
	Voltage Range Minimum/Maximum	V	342/456
	Electrical Characteristic Running Current Cooling/Heating	A	176.10/139.30
	Power Supply Wiring Starting Current	A	Soft Start
	Power Supply	V/ph/Hz	380-415/3/50
Suggested Fused Supply(s)	A	63 x 4 + 40	

\*Combination combined value, see stand alone for individual data

\*All [Accessories](#) / [Controls](#)

Related items:

- [Full specification](#)
- [CAD files](#)
- [Dimensional drawing](#)
- [Connection diagram](#)
- [Noise curve data](#)

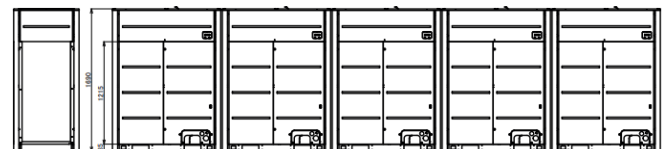

\*For further information see stand alone data

## VRF SMMSu R410a: UP11811HT8P-E

### COMBINATIONS

- Operating conditions from -25°C to +52°C.
- Up to 128 indoor units connected per system.
- Possibility to combine up to 5 outdoor units to achieve 120HP.
- Unique Triple Rotary Compressor and a totally redesigned chassis.
- Up to 1,200m total piping length with 250m from outdoor to the farthest indoor unit.



**SMMSu**  
SUPER MODULAR MULTI SYSTEM

Hi - Res Image

### Performance & Outdoor Data

Model & Combination		UP11811HT8P-E MUP2401HT8P-E x 4 MUP2201HT8P-E	
Capacity Range		HP	118
Maximum Number of Indoor Units		QTY	128
Cooling Capacity		kW	329.5
Heating Capacity		kW	329.5
Operating Range	Cooling	°C	-5.0 to 52.0
	Heating		-25.0 to 15.5
Cooling	Power Consumption	kW	117.19
	EER/SEER/Energy Efficiency Class (or nsc %)		2.81/6.93/274.2
Heating	Power Consumption	kW	92.10
	COP/SCOP/Energy Efficiency Class (or nsc(A) %)		3.58/4.23/166.2
Fan(s)	Standard Air Flow H	l/s	22915*
	Standard Air Flow H	m3/h	82500*
	External Static Pressure	Pa	80
Sound	Pressure Level C/H	dB(A)	70/74
	Power Level C/H	dB(A)	93/97
Unit(s)	Height x Width x Depth	mm	1690 x 6530 x 780
	Weight	kg	1780
Pipe Connections	Refrigerant Base Charge	kg	9 x 5
	Suction Gas Pipe Brazing	inch	2 1/8
	Liquid Pipe Flare	inch	7/8
	Equivalent Length	m	200
	Real Length	m	160
Maximum	Total Pipe Length (Liquid Line Real Length)	m	1200
	Length To First Branch	m	100
	Equivalent Length Of Outdoor Unit Connecting Pipe	m	10
	Real Length Of Indoor Unit Connecting Piping	m	30
	Equivalent Length Between Branches	m	50
	Height Difference Outdoor Higher Than Indoor Units	m	70 (110*)
	Height Difference Outdoor Lower Than Indoor Units	m	40 (110*)
	Height Difference Between Indoor Units	m	40
	Height Difference Between Outdoor Units	m	5
	Electrical	Voltage Range Minimum/Maximum	V
Electrical Characteristic Running Current Cooling/Heating		A	179.80/141.20
Power Supply Wiring Starting Current		A	Soft Start
Power Supply		V/ph/Hz	380-415/3/50
Suggested Fused Supply(s)		A	63 x 4 + 50

\*Combination combined value, see stand alone for individual data

\*All [Accessories](#) / [Controls](#)

Related items:

- [Full specification](#)
- [CAD files](#)
- [Dimensional drawing](#)
- [Connection diagram](#)
- [Noise curve data](#)

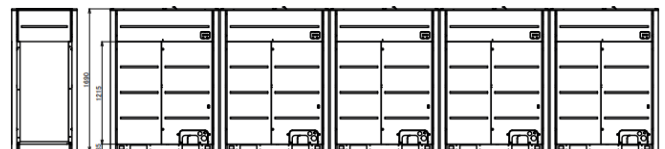

\*For further information see stand alone data

## VRF SMMSu R410a: UP12011HT8P-E

### COMBINATIONS

- Operating conditions from -25°C to +52°C.
- Up to 128 indoor units connected per system.
- Possibility to combine up to 5 outdoor units to achieve 120HP.
- Unique Triple Rotary Compressor and a totally redesigned chassis.
- Up to 1,200m total piping length with 250m from outdoor to the farthest indoor unit.



**SMMSu**  
SUPER MODULAR MULTI SYSTEM



Hi - Res Image

Performance & Outdoor Data		UP12011HT8P-E	
Model & Combination		MUP2401HT8P-E x 5	
Capacity Range		HP	120
Maximum Number of Indoor Units		QTY	128
Cooling Capacity		kW	335.0
Heating Capacity		kW	335.0
Operating Range	Cooling	°C	-5.0 to 52.0
	Heating		-25.0 to 15.5
Cooling	Power Consumption	kW	120.95
	EER/SEER/Energy Efficiency Class (or nsc %)		2.77/6.87/271.8
Heating	Power Consumption	kW	94.90
	COP/SCOP/Energy Efficiency Class (or nsc(A) %)		3.53/4.17/163.8
Fan(s)	Standard Air Flow H	l/s	22915*
	Standard Air Flow H	m3/h	82500*
	External Static Pressure	Pa	80
Sound	Pressure Level C/H	dB(A)	70/74
	Power Level C/H	dB(A)	93/97
Unit(s)	Height x Width x Depth	mm	1690 x 6530 x 780
	Weight	kg	1780
Pipe Connections	Refrigerant Base Charge	kg	9 x5
	Suction Gas Pipe Brazing	inch	2 1/8
Maximum	Liquid Pipe Flare	inch	7/8
	Equivalent Length	m	200
	Real Length	m	160
	Total Pipe Length (Liquid Line Real Length)	m	1200
	Length To First Branch	m	100
	Equivalent Length Of Outdoor Unit Connecting Pipe	m	10
	Real Length Of Indoor Unit Connecting Piping	m	30
	Equivalent Length Between Branches	m	50
	Height Difference Outdoor Higher Than Indoor Units	m	70 (110*)
	Height Difference Outdoor Lower Than Indoor Units	m	40 (110*)
Electrical	Height Difference Between Indoor Units	m	40
	Height Difference Between Outdoor Units	m	5
	Voltage Range Minimum/Maximum	V	342/456
	Electrical Characteristic Running Current Cooling/Heating	A	185.50/145.50
	Power Supply Wiring Starting Current	A	Soft Start
Power Supply	V/ph/Hz	380-415/3/50	
Suggested Fused Supply(s)	A	63 x 5	

\*Combination combined value, see stand alone for individual data

\*All [Accessories](#) / [Controls](#)

Related items:

- [Full specification](#)
- [CAD files](#)
- [Dimensional drawing](#)
- [Connection diagram](#)
- [Noise curve data](#)



\*For further information see stand alone data



# SHRM<sub>e</sub>



## VRF SHRMe R410a: MMY - MAP0806FT8P-UK

### STAND ALONE

- SHRMe can reach up to 1,000 meters maximum piping length.
- Surface area increased by 13% with 3-row heat exchanger enhancing efficiency.
- Toshiba's unique combination of twin rotary compressors and inverter driven control.
- Emphasis on driving excellence in energy savings and enhancement in applications.
- Unique Diamond Like Carbon Coating technology offers outstanding wear resistance.



Hi - Res Image 

Performance & Outdoor Data			
Capacity Range		HP	8
Maximum Number of Indoor Units		QTY	18
Cooling Capacity		kW	22.4
Heating Capacity		kW	25.0
Operating Range	Cooling	°C	-10.0 to 46.0
	Heating		-25.0 to 15.5
Cooling	Power Consumption	kW	5.95
	EER/SEER/Energy Efficiency Class (or nsc %)		3.76/6.19/244.6
Heating	Power Consumption	kW	5.40
	COP/SCOP/Energy Efficiency Class (or nsc(A) %)		4.14/3.64/142.6
Fan(s)	Standard Air Flow H	l/s	2694
	Standard Air Flow H	m <sup>3</sup> /h	9700
	External Static Pressure	Pa	60
Sound	Pressure Level C/H	dB(A)	59/61
	Power Level C/H	dB(A)	80/82
Unit(s)	Height x Width x Depth	mm	1830 x 990 x 780
	Weight	kg	263
Pipe Connections	Refrigerant Base Charge	kg	11
	Suction Gas Pipe Brazing	inch	7/8
	Discharge Pipe Brazing	inch	3/4
	Liquid Pipe Flare	inch	1/2
	Balance Pipe Flare	inch	3/8
	Equivalent Length	m	200
	Real Length	m	180
	Total Pipe Length (Liquid Line Real Length)	m	300
	Length To First Branch Height Difference Between Indoor Units ≤ 3 m	m	100
	Length To First Branch Height Difference Between Indoor Units > 3 m	m	85
Maximum	Equivalent Length Of Outdoor Unit Connecting Pipe	m	10
	Real Length Between Single Port FS Unit and Indoor Unit (3 series)	m	50 (15)
	Real Length Between Multi Port FS Unit and Indoor Unit	m	50
	Real Length Of Indoor Unit Connecting Piping	m	30
	Equivalent Length Between Branches	m	50
	Height Difference Outdoor Higher Than Indoor Units	m	70
	Height Difference Outdoor Lower Than Indoor Units	m	30
	Height Difference Between Indoor Units	m	40
	Height Difference Between Outdoor Units	m	5
	Electrical	Voltage Range Minimum/Maximum	V
Electrical Characteristic Running Current Cooling/Heating		A	9.44/8.57
Power Supply Wiring Starting Current		A	Soft Start
Power Supply		V/ph/Hz	380-415/3/50
Suggested Fused Supply(s)		A	20

\*All [Accessories](#) / [Controls](#)

Related items:

- [Full specification](#)
- [BIM files](#)
- [CAD files](#)
- [Refrigerant cycle](#)
- [Dimensional drawing](#)
- [Wiring diagram](#)
- [Noise curve data](#)
- [Installation manual](#)

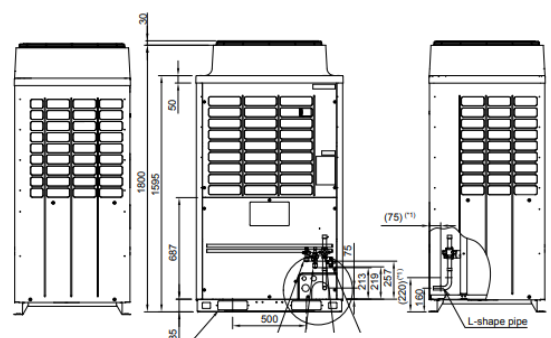

## VRF SHRM<sub>e</sub> R410a: MMY - MAP1006FT8P-UK

### STAND ALONE

- SHRM-e can reach up to 1,000 meters maximum piping length.
- Surface area increased by 13% with 3-row heat exchanger enhancing efficiency.
- Toshiba's unique combination of twin rotary compressors and inverter driven control.
- Emphasis on driving excellence in energy savings and enhancement in applications.
- Unique Diamond Like Carbon Coating technology offers outstanding wear resistance.



Hi - Res Image 

### Performance & Outdoor Data

Capacity Range		HP	10
Maximum Number of Indoor Units		QTY	22
Cooling Capacity		kW	28.0
Heating Capacity		kW	31.5
Operating Range	Cooling	°C	-10.0 to 46.0
	Heating		-25.0 to 15.5
Cooling	Power Consumption	kW	7.96
	EER/SEER/Energy Efficiency Class (or nsc %)		3.51/6.13/242.2
Heating	Power Consumption	kW	7.05
	COP/SCOP/Energy Efficiency Class (or nsc(A) %)		3.97/3.54/138.6
Fan(s)	Standard Air Flow H	l/s	2694
	Standard Air Flow H	m <sup>3</sup> /h	9700
	External Static Pressure	Pa	50
Sound	Pressure Level C/H	dB(A)	59/61
	Power Level C/H	dB(A)	80/82
Unit(s)	Height x Width x Depth	mm	1830 x 990 x 780
	Weight	kg	263
Pipe Connections	Refrigerant Base Charge	kg	11
	Suction Gas Pipe Brazing	inch	7/8
	Discharge Pipe Brazing	inch	3/4
	Liquid Pipe Flare	inch	1/2
	Balance Pipe Flare	inch	3/8
	Equivalent Length	m	200
	Real Length	m	180
Maximum	Total Pipe Length (Liquid Line Real Length)	m	300
	Length To First Branch Height Difference Between Indoor Units ≤ 3 m	m	100
	Length To First Branch Height Difference Between Indoor Units > 3 m	m	85
	Equivalent Length Of Outdoor Unit Connecting Pipe	m	10
	Real Length Between Single Port FS Unit and Indoor Unit (3 series)	m	50 (15)
	Real Length Between Multi Port FS Unit and Indoor Unit	m	50
	Real Length Of Indoor Unit Connecting Piping	m	30
	Equivalent Length Between Branches	m	50
	Height Difference Outdoor Higher Than Indoor Units	m	70
	Height Difference Outdoor Lower Than Indoor Units	m	30
	Height Difference Between Indoor Units	m	40
	Height Difference Between Outdoor Units	m	5
	Electrical	Voltage Range Minimum/Maximum	V
Electrical Characteristic Running Current Cooling/Heating		A	12.49/11.06
Power Supply Wiring Starting Current		A	Soft Start
Power Supply		V/ph/Hz	380-415/3/50
Suggested Fused Supply(s)		A	25

### \*All Accessories / Controls

#### Related items:

- [Full specification](#)
- [BIM files](#)
- [CAD files](#)
- [Refrigerant cycle](#)
- [Dimensional drawing](#)
- [Wiring diagram](#)
- [Noise curve data](#)
- [Installation manual](#)

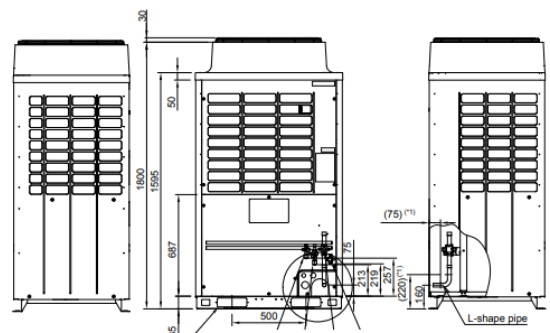



## VRF SHRMe R410a: MMY - MAP1206FT8P-UK

### STAND ALONE

- SHRMe can reach up to 1,000 meters maximum piping length.
- Surface area increased by 13% with 3-row heat exchanger enhancing efficiency.
- Toshiba's unique combination of twin rotary compressors and inverter driven control.
- Emphasis on driving excellence in energy savings and enhancement in applications.
- Unique Diamond Like Carbon Coating technology offers outstanding wear resistance.



Hi - Res Image

### Performance & Outdoor Data

Capacity Range		HP	12
Maximum Number of Indoor Units		QTY	27
Cooling Capacity		kW	33.5
Heating Capacity		kW	37.5
Operating Range	Cooling	°C	-10.0 to 46.0
	Heating		-25.0 to 15.5
Cooling	Power Consumption	kW	9.75
	EER/SEER/Energy Efficiency Class (or nsc %)		3.43/6.02/237.8
Heating	Power Consumption	kW	8.70
	COP/SCOP/Energy Efficiency Class (or nsc(A) %)		3.85/3.71/145.4
Fan(s)	Standard Air Flow H	l/s	3389
	Standard Air Flow H	m <sup>3</sup> /h	12200
	External Static Pressure	Pa	50
Sound	Pressure Level C/H	dB(A)	60/62
	Power Level C/H	dB(A)	80/82
Unit(s)	Height x Width x Depth	mm	1830 x 1210 x 780
	Weight	kg	316
Pipe Connections	Refrigerant Base Charge	kg	11
	Suction Gas Pipe Brazing	inch	1-1/8
	Discharge Pipe Brazing	inch	3/4
	Liquid Pipe Flare	inch	1/2
	Balance Pipe Flare	inch	3/8
	Equivalent Length	m	200
	Real Length	m	180
	Total Pipe Length (Liquid Line Real Length)	m	300
	Length To First Branch Height Difference Between Indoor Units ≤ 3 m	m	100
	Length To First Branch Height Difference Between Indoor Units > 3 m	m	85
Maximum	Equivalent Length Of Outdoor Unit Connecting Pipe	m	10
	Real Length Between Single Port FS Unit and Indoor Unit (3 series)	m	50 (15)
	Real Length Between Multi Port FS Unit and Indoor Unit	m	50
	Real Length Of Indoor Unit Connecting Piping	m	30
	Equivalent Length Between Branches	m	50
	Height Difference Outdoor Higher Than Indoor Units	m	70
	Height Difference Outdoor Lower Than Indoor Units	m	30
	Height Difference Between Indoor Units	m	40
	Height Difference Between Outdoor Units	m	5
	Electrical	Voltage Range Minimum/Maximum	V
Electrical Characteristic Running Current Cooling/Heating		A	15.46/13.8
Power Supply Wiring Starting Current		A	Soft Start
Power Supply		V/ph/Hz	380-415/3/50
Suggested Fused Supply(s)		A	25

### \*All Accessories / Controls

#### Related items:

- [Full specification](#)
- [BIM files](#)
- [CAD files](#)
- [Refrigerant cycle](#)
- [Dimensional drawing](#)
- [Wiring diagram](#)
- [Noise curve data](#)
- [Installation manual](#)

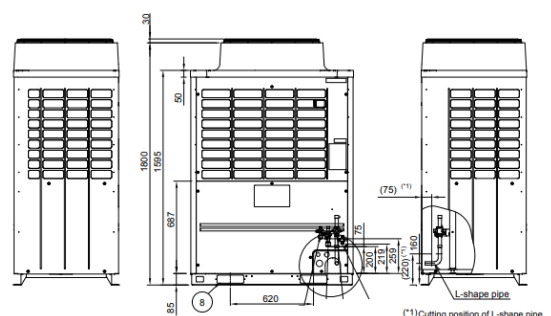

## VRF SHRM<sub>e</sub> R410a: MMY - MAP1406FT8P-UK

### STAND ALONE

- SHRM-e can reach up to 1,000 meters maximum piping length.
- Surface area increased by 13% with 3-row heat exchanger enhancing efficiency.
- Toshiba's unique combination of twin rotary compressors and inverter driven control.
- Emphasis on driving excellence in energy savings and enhancement in applications.
- Unique Diamond Like Carbon Coating technology offers outstanding wear resistance.



Hi - Res Image

### Performance & Outdoor Data

Capacity Range		HP	14
Maximum Number of Indoor Units		QTY	31
Cooling Capacity		kW	40.0
Heating Capacity		kW	45.0
Operating Range	Cooling	°C	-10.0 to 46.0
	Heating		-25.0 to 15.5
Cooling	Power Consumption	kW	12.70
	EER/SEER/Energy Efficiency Class (or nsc %)		3.14/5.67/223.8
Heating	Power Consumption	kW	10.50
	COP/SCOP/Energy Efficiency Class (or nsc(A) %)		3.80/3.57/139.8
Fan(s)	Standard Air Flow H	l/s	3389
	Standard Air Flow H	m <sup>3</sup> /h	12200
	External Static Pressure	Pa	40
Sound	Pressure Level C/H	dB(A)	62/64
	Power Level C/H	dB(A)	81/83
Unit(s)	Height x Width x Depth	mm	1830 x 1210 x 780
	Weight	kg	316
Pipe Connections	Refrigerant Base Charge	kg	11
	Suction Gas Pipe Brazing	inch	1-1/8
	Discharge Pipe Brazing	inch	7/8
	Liquid Pipe Flare	inch	5/8
	Balance Pipe Flare	inch	3/8
	Equivalent Length	m	200
	Real Length	m	180
	Total Pipe Length (Liquid Line Real Length)	m	300
	Length To First Branch Height Difference Between Indoor Units ≤ 3 m	m	100
	Length To First Branch Height Difference Between Indoor Units > 3 m	m	85
Maximum	Equivalent Length Of Outdoor Unit Connecting Pipe	m	10
	Real Length Between Single Port FS Unit and Indoor Unit (3 series)	m	50 (15)
	Real Length Between Multi Port FS Unit and Indoor Unit	m	50
	Real Length Of Indoor Unit Connecting Piping	m	30
	Equivalent Length Between Branches	m	50
	Height Difference Outdoor Higher Than Indoor Units	m	70
	Height Difference Outdoor Lower Than Indoor Units	m	30
	Height Difference Between Indoor Units	m	40
	Height Difference Between Outdoor Units	m	5
	Electrical	Voltage Range Minimum/Maximum	V
Electrical Characteristic Running Current Cooling/Heating		A	19.92/16.47
Power Supply Wiring Starting Current		A	Soft Start
Power Supply		V/ph/Hz	380-415/3/50
Suggested Fused Supply(s)		A	32

### \*All Accessories / Controls

#### Related items:

- [Full specification](#)
- [BIM files](#)
- [CAD files](#)
- [Refrigerant cycle](#)
- [Dimensional drawing](#)
- [Wiring diagram](#)
- [Noise curve data](#)
- [Installation manual](#)

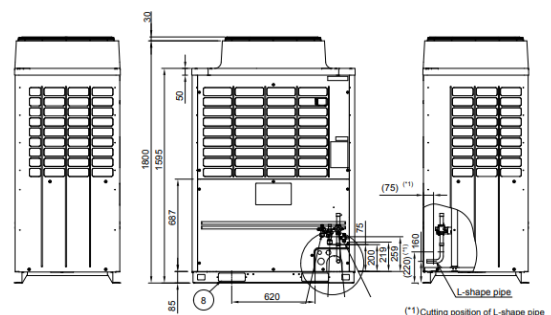

## VRF SHRMe R410a: MMY - MAP1606FT8P-UK

### STAND ALONE

- SHRMe can reach up to 1,000 meters maximum piping length.
- Surface area increased by 13% with 3-row heat exchanger enhancing efficiency.
- Toshiba's unique combination of twin rotary compressors and inverter driven control.
- Emphasis on driving excellence in energy savings and enhancement in applications.
- Unique Diamond Like Carbon Coating technology offers outstanding wear resistance.



Hi - Res Image 

### Performance & Outdoor Data

Capacity Range		HP	16
Maximum Number of Indoor Units		QTY	36
Cooling Capacity		kW	45.0
Heating Capacity		kW	50.0
Operating Range	Cooling	°C	-10.0 to 46.0
	Heating		-25.0 to 15.5
Cooling	Power Consumption	kW	13.90
	EER/SEER/Energy Efficiency Class (or nsc %)		3.23/5.78/228.2
Heating	Power Consumption	kW	12.20
	COP/SCOP/Energy Efficiency Class (or nsc(A) %)		3.68/3.51/137.4
Fan(s)	Standard Air Flow H	l/s	4806
	Standard Air Flow H	m <sup>3</sup> /h	17300
	External Static Pressure	Pa	40
Sound	Pressure Level C/H	dB(A)	61/62
	Power Level C/H	dB(A)	83/84
Unit(s)	Height x Width x Depth	mm	1830 x 1600 x 780
	Weight	kg	377
Pipe Connections	Refrigerant Base Charge	kg	11
	Suction Gas Pipe Brazing	inch	1-1/8
	Discharge Pipe Brazing	inch	7/8
	Liquid Pipe Flare	inch	3/4
	Balance Pipe Flare	inch	3/8
	Equivalent Length	m	200
	Real Length	m	180
Maximum	Total Pipe Length (Liquid Line Real Length)	m	300
	Length To First Branch Height Difference Between Indoor Units ≤ 3 m	m	100
	Length To First Branch Height Difference Between Indoor Units > 3 m	m	85
	Equivalent Length Of Outdoor Unit Connecting Pipe	m	10
	Real Length Between Single Port FS Unit and Indoor Unit (3 series)	m	50 (15)
	Real Length Between Multi Port FS Unit and Indoor Unit	m	50
	Real Length Of Indoor Unit Connecting Piping	m	30
	Equivalent Length Between Branches	m	50
	Height Difference Outdoor Higher Than Indoor Units	m	70
	Height Difference Outdoor Lower Than Indoor Units	m	30
	Height Difference Between Indoor Units	m	40
	Height Difference Between Outdoor Units	m	5
	Electrical	Voltage Range Minimum/Maximum	V
Electrical Characteristic Running Current Cooling/Heating		A	21.81/19.14
Power Supply Wiring Starting Current		A	Soft Start
Power Supply		V/ph/Hz	380-415/3/50
Suggested Fused Supply(s)		A	40

### \*All Accessories / Controls

#### Related items:

- [Full specification](#)
- [BIM files](#)
- [CAD files](#)
- [Refrigerant cycle](#)
- [Dimensional drawing](#)
- [Wiring diagram](#)
- [Noise curve data](#)
- [Installation manual](#)

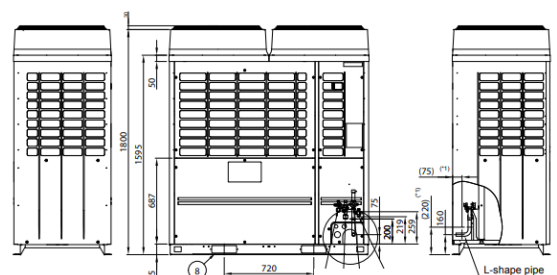

## VRF SHRM<sub>e</sub> R410a: MMY - MAP1806FT8P-UK

### STAND ALONE

- SHRM-e can reach up to 1,000 meters maximum piping length.
- Surface area increased by 13% with 3-row heat exchanger enhancing efficiency.
- Toshiba's unique combination of twin rotary compressors and inverter driven control.
- Emphasis on driving excellence in energy savings and enhancement in applications.
- Unique Diamond Like Carbon Coating technology offers outstanding wear resistance.



Hi - Res Image 

### Performance & Outdoor Data

Capacity Range		HP	18
Maximum Number of Indoor Units		QTY	40
Cooling Capacity		kW	50.4
Heating Capacity		kW	56.5
Operating Range	Cooling	°C	-10.0 to 46.0
	Heating		-25.0 to 15.5
Cooling	Power Consumption	kW	16.00
	EER/SEER/Energy Efficiency Class (or nsc %)		3.15/5.94/234.6
Heating	Power Consumption	kW	13.70
	COP/SCOP/Energy Efficiency Class (or nsc(A) %)		3.67/3.59/140.6
Fan(s)	Standard Air Flow H	l/s	4806
	Standard Air Flow H	m <sup>3</sup> /h	17300
	External Static Pressure	Pa	40
Sound	Pressure Level C/H	dB(A)	61/62
	Power Level C/H	dB(A)	83/84
Unit(s)	Height x Width x Depth	mm	1830 x 1600 x 780
	Weight	kg	377
Pipe Connections	Refrigerant Base Charge	kg	11
	Suction Gas Pipe Brazing	inch	1-1/8
	Discharge Pipe Brazing	inch	7/8
	Liquid Pipe Flare	inch	3/4
	Balance Pipe Flare	inch	3/8
	Equivalent Length	m	200
	Real Length	m	180
	Total Pipe Length (Liquid Line Real Length)	m	300
	Length To First Branch Height Difference Between Indoor Units ≤ 3 m	m	100
	Length To First Branch Height Difference Between Indoor Units > 3 m	m	85
Maximum	Equivalent Length Of Outdoor Unit Connecting Pipe	m	10
	Real Length Between Single Port FS Unit and Indoor Unit (3 series)	m	50 (15)
	Real Length Between Multi Port FS Unit and Indoor Unit	m	50
	Real Length Of Indoor Unit Connecting Piping	m	30
	Equivalent Length Between Branches	m	50
	Height Difference Outdoor Higher Than Indoor Units	m	70
	Height Difference Outdoor Lower Than Indoor Units	m	30
	Height Difference Between Indoor Units	m	40
	Height Difference Between Outdoor Units	m	5
	Electrical	Voltage Range Minimum/Maximum	V
Electrical Characteristic Running Current Cooling/Heating		A	25.1/21.49
Power Supply Wiring Starting Current		A	Soft Start
Power Supply		V/ph/Hz	380-415/3/50
Suggested Fused Supply(s)		A	40

### \*All Accessories / Controls

#### Related items:

- [Full specification](#)
- [BIM files](#)
- [CAD files](#)
- [Refrigerant cycle](#)
- [Dimensional drawing](#)
- [Wiring diagram](#)
- [Noise curve data](#)
- [Installation manual](#)

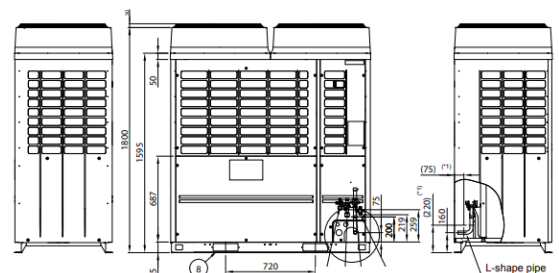

## VRF SHRMe R410a: MMY - MAP2006FT8P-UK

### STAND ALONE

- SHRMe can reach up to 1,000 meters maximum piping length.
- Surface area increased by 13% with 3-row heat exchanger enhancing efficiency.
- Toshiba's unique combination of twin rotary compressors and inverter driven control.
- Emphasis on driving excellence in energy savings and enhancement in applications.
- Unique Diamond Like Carbon Coating technology offers outstanding wear resistance.



Hi - Res Image

### Performance & Outdoor Data

Capacity Range		HP	20
Maximum Number of Indoor Units		QTY	41
Cooling Capacity		kW	56.0
Heating Capacity		kW	58.0
Operating Range	Cooling	°C	-10.0 to 46.0
	Heating		-25.0 to 15.5
Cooling	Power Consumption	kW	18.60
	EER/SEER/Energy Efficiency Class (or nsc %)		3.01/5.68/224.2
Heating	Power Consumption	kW	15.90
	COP/SCOP/Energy Efficiency Class (or nsc(A) %)		3.52/3.60/141.0
Fan(s)	Standard Air Flow H	l/s	4972
	Standard Air Flow H	m <sup>3</sup> /h	17900
	External Static Pressure	Pa	40
Sound	Pressure Level C/H	dB(A)	61/62
	Power Level C/H	dB(A)	83/84
Unit(s)	Height x Width x Depth	mm	1830 x 1600 x 780
	Weight	kg	377
Pipe Connections	Refrigerant Base Charge	kg	11
	Suction Gas Pipe Brazing	inch	1-1/8
	Discharge Pipe Brazing	inch	7/8
	Liquid Pipe Flare	inch	3/4
	Balance Pipe Flare	inch	3/8
	Equivalent Length	m	200
	Real Length	m	180
Maximum	Total Pipe Length (Liquid Line Real Length)	m	300
	Length To First Branch Height Difference Between Indoor Units ≤ 3 m	m	100
	Length To First Branch Height Difference Between Indoor Units > 3 m	m	85
	Equivalent Length Of Outdoor Unit Connecting Pipe	m	10
	Real Length Between Single Port FS Unit and Indoor Unit (3 series)	m	50 (15)
	Real Length Between Multi Port FS Unit and Indoor Unit	m	50
	Real Length Of Indoor Unit Connecting Piping	m	30
	Equivalent Length Between Branches	m	50
	Height Difference Outdoor Higher Than Indoor Units	m	70
	Height Difference Outdoor Lower Than Indoor Units	m	30
	Height Difference Between Indoor Units	m	40
	Height Difference Between Outdoor Units	m	5
	Electrical	Voltage Range Minimum/Maximum	V
Electrical Characteristic Running Current Cooling/Heating		A	29.18/24.68
Power Supply Wiring Starting Current		A	Soft Start
Power Supply		V/ph/Hz	380-415/3/50
Suggested Fused Supply(s)		A	50

### \*All Accessories / Controls

#### Related items:

- [Full specification](#)
- [BIM files](#)
- [CAD files](#)
- [Refrigerant cycle](#)
- [Dimensional drawing](#)
- [Wiring diagram](#)
- [Noise curve data](#)
- [Installation manual](#)

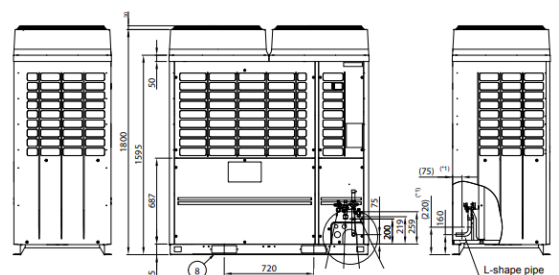

## VRF SHRMe R410a: AP2216FT8P-UK

### COMBINATIONS

- SHRMe can reach up to 1,000 meters maximum piping length.
- Surface area increased by 13% with 3-row heat exchanger enhancing efficiency.
- Toshiba's unique combination of twin rotary compressors and inverter driven control.
- Emphasis on driving excellence in energy savings and enhancement in applications.
- Unique Diamond Like Carbon Coating technology offers outstanding wear resistance.



Hi - Res Image

### Performance & Outdoor Data

Model & Combination		AP2216FT8P-UK MAP1206FT8P-UK MAP1006FT8P-UK	
Capacity Range		HP	22
Maximum Number of Indoor Units		QTY	49
Cooling Capacity		kW	61.5
Heating Capacity		kW	69.0
Operating Range	Cooling	°C	-10.0 to 46.0
	Heating		-25.0 to 15.5
Cooling	Power Consumption	kW	17.71
	EER/SEER/Energy Efficiency Class (or nsc %)		3.47/6.07/239.8
Heating	Power Consumption	kW	15.75
	COP/SCOP/Energy Efficiency Class (or nsc(A) %)		3.90/3.64/142.6
Fan(s)	Standard Air Flow H	l/s	6083*
	Standard Air Flow H	m3/h	21900*
	External Static Pressure	Pa	50
Sound	Pressure Level C/H	dB(A)	63/65
	Power Level C/H	dB(A)	83.5/85.5
Unit(s)	Height x Width x Depth	mm	1830 x 2220 x 780
	Weight	kg	579
Pipe Connections	Refrigerant Base Charge	kg	11 x2
	Suction Gas Pipe Brazing	inch	1-3/8
	Discharge Pipe Brazing	inch	1-1/8
	Liquid Pipe Flare	inch	3/4
	Balance Pipe Flare	inch	3/8
Maximum	Equivalent Length	m	200
	Real Length	m	180
	Total Pipe Length (Liquid Line Real Length)	m	300
	Length To First Branch Height Difference Between Indoor Units ≤ 3 m	m	100
	Length To First Branch Height Difference Between Indoor Units > 3 m	m	85
	Equivalent Length Of Outdoor Unit Connecting Pipe	m	10
	Equivalent Length Between Branches	m	50
	Height Difference Outdoor Higher Than Indoor Units	m	70
	Height Difference Outdoor Lower Than Indoor Units	m	30
Electrical	Electrical Characteristic Running Current Cooling/Heating	A	27.94/24.85
	Power Supply	V/ph/Hz	380-415/3/50
	Suggested Fused Supply(s)	A	25 x 2

\*Combination combined value, see stand alone for individual data

\*All [Accessories](#) / [Controls](#)

Related items:

- [Full specification](#)
- [Dimensional drawing](#)
- [Connection diagram](#)
- [Noise curve data](#)

\*For further information see stand alone data

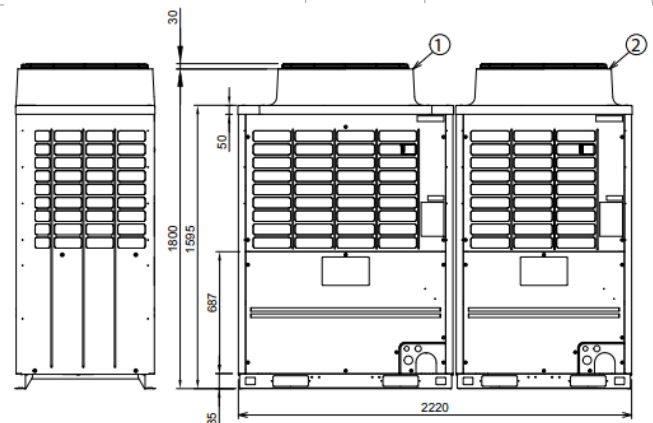

## VRF SHRMe R410a: **AP2416FT8P-UK**

### COMBINATIONS

- SHRMe can reach up to 1,000 meters maximum piping length.
- Surface area increased by 13% with 3-row heat exchanger enhancing efficiency.
- Toshiba's unique combination of twin rotary compressors and inverter driven control.
- Emphasis on driving excellence in energy savings and enhancement in applications.
- Unique Diamond Like Carbon Coating technology offers outstanding wear resistance.



Hi - Res Image 

### Performance & Outdoor Data

Model & Combination		AP2416FT8P-UK MAP1406FT8P-UK MAP1006FT8P-UK	
Capacity Range		HP	24
Maximum Number of Indoor Units		QTY	54
Cooling Capacity		kW	68.0
Heating Capacity		kW	76.5
Operating Range	Cooling	°C	-10.0 to 46.0
	Heating		-25.0 to 15.5
Cooling	Power Consumption	kW	20.66
	EER/SEER/Energy Efficiency Class (or nsc %)		3.29/5.88/232.2
Heating	Power Consumption	kW	17.55
	COP/SCOP/Energy Efficiency Class (or nsc(A) %)		3.87/3.56/139.4
Fan(s)	Standard Air Flow H	l/s	6083*
	Standard Air Flow H	m3/h	21900*
	External Static Pressure	Pa	40
Sound	Pressure Level C/H	dB(A)	64/66
	Power Level C/H	dB(A)	84/86
Unit(s)	Height x Width x Depth	mm	1830 x 2220 x 780
	Weight	kg	579
Pipe Connections	Refrigerant Base Charge	kg	11 x2
	Suction Gas Pipe Brazing	inch	1-3/8
	Discharge Pipe Brazing	inch	1-1/8
	Liquid Pipe Flare	inch	3/4
	Balance Pipe Flare	inch	3/8
Maximum	Equivalent Length	m	200
	Real Length	m	180
	Total Pipe Length (Liquid Line Real Length)	m	300
	Length To First Branch Height Difference Between Indoor Units ≤ 3 m	m	100
	Length To First Branch Height Difference Between Indoor Units > 3 m	m	85
	Equivalent Length Of Outdoor Unit Connecting Pipe	m	10
	Equivalent Length Between Branches	m	50
	Height Difference Outdoor Higher Than Indoor Units	m	70
Height Difference Outdoor Lower Than Indoor Units	m	30	
Electrical	Electrical Characteristic Running Current Cooling/Heating	A	32.41/27.53
	Power Supply	V/ph/Hz	380-415/3/50
	Suggested Fused Supply(s)	A	32 + 25

\*Combination combined value, see stand alone for individual data

\*All [Accessories](#) / [Controls](#)

Related items:

- [Full specification](#)
- [Dimensional drawing](#)
- [Connection diagram](#)
- [Noise curve data](#)



\*For further information see stand alone data

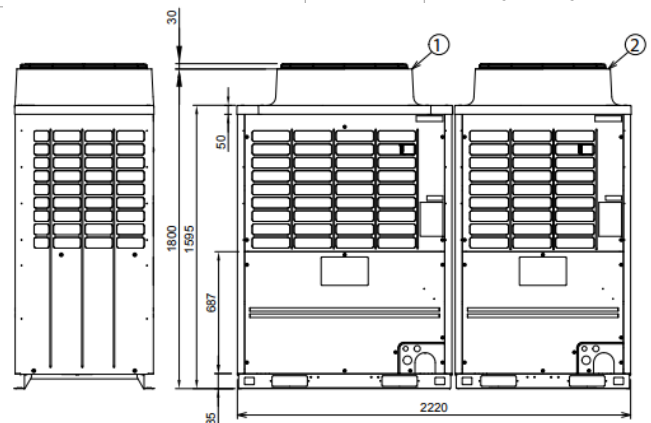

## VRF SHRMe R410a: **AP2616FT8P-UK**

### COMBINATIONS

- SHRMe can reach up to 1,000 meters maximum piping length.
- Surface area increased by 13% with 3-row heat exchanger enhancing efficiency.
- Toshiba's unique combination of twin rotary compressors and inverter driven control.
- Emphasis on driving excellence in energy savings and enhancement in applications.
- Unique Diamond Like Carbon Coating technology offers outstanding wear resistance.



Hi - Res Image

### Performance & Outdoor Data

Model & Combination		AP2616FT8P-UK MAP1406FT8P-UK MAP1206FT8P-UK	
Capacity Range		HP	26
Maximum Number of Indoor Units		QTY	58
Cooling Capacity		kW	73.5
Heating Capacity		kW	82.5
Operating Range	Cooling	°C	-10.0 to 46.0
	Heating		-25.0 to 15.5
Cooling	Power Consumption	kW	22.45
	EER/SEER/Energy Efficiency Class (or nsc %)		3.27/5.84/230.6
Heating	Power Consumption	kW	19.20
	COP/SCOP/Energy Efficiency Class (or nsc(A) %)		3.83/3.64/142.6
Fan(s)	Standard Air Flow H	l/s	6778
	Standard Air Flow H	m3/h	24400
	External Static Pressure	Pa	40
Sound	Pressure Level C/H	dB(A)	64.5/66.5
	Power Level C/H	dB(A)	84/86
Unit(s)	Height x Width x Depth	mm	1830 x 2440 x 780
	Weight	kg	632
Pipe Connections	Refrigerant Base Charge	kg	11 x2
	Suction Gas Pipe Brazing	inch	1-3/8
	Discharge Pipe Brazing	inch	1-1/8
	Liquid Pipe Flare	inch	7/8
	Balance Pipe Flare	inch	3/8
Maximum	Equivalent Length	m	200
	Real Length	m	180
	Total Pipe Length (Liquid Line Real Length)	m	300
	Length To First Branch Height Difference Between Indoor Units ≤ 3 m	m	100
	Length To First Branch Height Difference Between Indoor Units > 3 m	m	85
	Equivalent Length Of Outdoor Unit Connecting Pipe	m	10
	Equivalent Length Between Branches	m	50
	Height Difference Outdoor Higher Than Indoor Units	m	70
Height Difference Outdoor Lower Than Indoor Units	m	30	
Electrical	Electrical Characteristic Running Current Cooling/Heating	A	35.41/30.29
	Power Supply	V/ph/Hz	380-415/3/50
	Suggested Fused Supply(s)	A	32 + 25

\*Combination combined value, see stand alone for individual data

\*All [Accessories](#) / [Controls](#)

Related items:

- [Full specification](#)
- [Dimensional drawing](#)
- [Connection diagram](#)
- [Noise curve data](#)

\*For further information see stand alone data

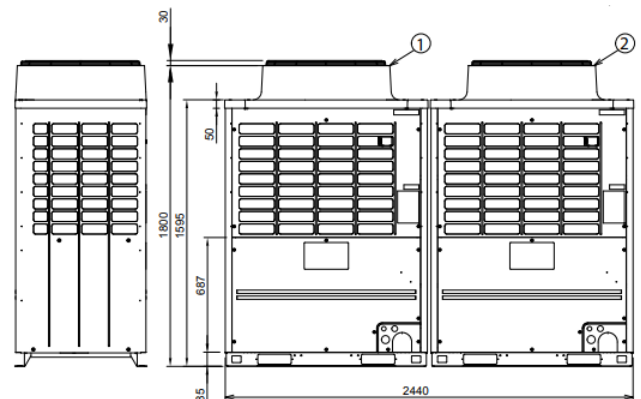



## VRF SHRMe R410a: **AP2816FT8P-UK**

### COMBINATIONS

- SHRMe can reach up to 1,000 meters maximum piping length.
- Surface area increased by 13% with 3-row heat exchanger enhancing efficiency.
- Toshiba's unique combination of twin rotary compressors and inverter driven control.
- Emphasis on driving excellence in energy savings and enhancement in applications.
- Unique Diamond Like Carbon Coating technology offers outstanding wear resistance.



Hi - Res Image 

### Performance & Outdoor Data

Model & Combination		AP2816FT8P-UK	
		MAP1406FT8P-UK x 2	
Capacity Range		HP	28
Maximum Number of Indoor Units		QTY	63
Cooling Capacity		kW	80.0
Heating Capacity		kW	90.0
Operating Range	Cooling	°C	-10.0 to 46.0
	Heating		-25.0 to 15.5
Cooling	Power Consumption	kW	25.40
	EER/SEER/Energy Efficiency Class (or nsc %)		3.15/5.67/223.8
Heating	Power Consumption	kW	21.00
	COP/SCOP/Energy Efficiency Class (or nsc(A) %)		3.81/3.57/139.8
Fan(s)	Standard Air Flow H	l/s	6778*
	Standard Air Flow H	m3/h	24400*
	External Static Pressure	Pa	40
Sound	Pressure Level C/H	dB(A)	65.5/67.5
	Power Level C/H	dB(A)	84.5/86.5
Unit(s)	Height x Width x Depth	mm	1830 x 2440 x 780
	Weight	kg	632
Pipe Connections	Refrigerant Base Charge	kg	11 x2
	Suction Gas Pipe Brazing	inch	1-3/8
	Discharge Pipe Brazing	inch	1-1/8
	Liquid Pipe Flare	inch	7/8
	Balance Pipe Flare	inch	3/8
Maximum	Equivalent Length	m	200
	Real Length	m	180
	Total Pipe Length (Liquid Line Real Length)	m	300
	Length To First Branch Height Difference Between Indoor Units ≤ 3 m	m	100
	Length To First Branch Height Difference Between Indoor Units > 3 m	m	85
	Equivalent Length Of Outdoor Unit Connecting Pipe	m	10
	Equivalent Length Between Branches	m	50
	Height Difference Outdoor Higher Than Indoor Units	m	70
Electrical	Height Difference Outdoor Lower Than Indoor Units	m	30
	Electrical Characteristic Running Current Cooling/Heating	A	39.85/32.95
	Power Supply	V/ph/Hz	380-415/3/50
	Suggested Fused Supply(s)	A	32 x 2

\*Combination combined value, see stand alone for individual data

\*All [Accessories](#) / [Controls](#)

Related items:

- [Full specification](#)
- [Dimensional drawing](#)
- [Connection diagram](#)
- [Noise curve data](#)



\*For further information see stand alone data

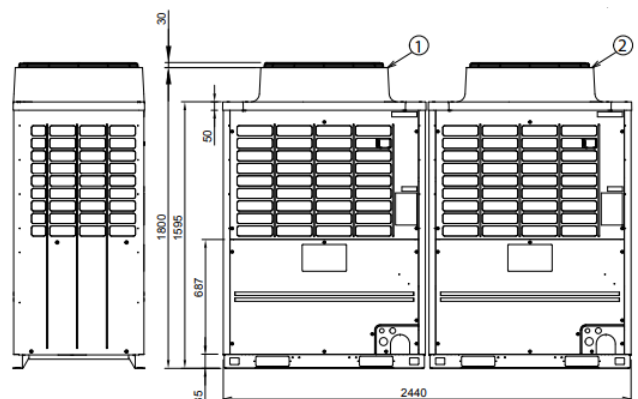

## VRF SHRM<sub>e</sub> R410a: **AP3016FT8P-UK**

### COMBINATIONS

- SHRM-e can reach up to 1,000 meters maximum piping length.
- Surface area increased by 13% with 3-row heat exchanger enhancing efficiency.
- Toshiba's unique combination of twin rotary compressors and inverter driven control.
- Emphasis on driving excellence in energy savings and enhancement in applications.
- Unique Diamond Like Carbon Coating technology offers outstanding wear resistance.



Hi - Res Image

### Performance & Outdoor Data

Model & Combination		AP3016FT8P-UK MAP1606FT8P-UK MAP1406FT8P-UK	
Capacity Range		HP	30
Maximum Number of Indoor Units		QTY	64
Cooling Capacity		kW	85.0
Heating Capacity		kW	95.0
Operating Range	Cooling	°C	-10.0 to 46.0
	Heating		-25.0 to 15.5
Cooling	Power Consumption	kW	26.60
	EER/SEER/Energy Efficiency Class (or nsc %)		3.20/5.72/225.8
Heating	Power Consumption	kW	22.70
	COP/SCOP/Energy Efficiency Class (or nsc(A) %)		3.74/3.54/138.6
Fan(s)	Standard Air Flow H	l/s	8195*
	Standard Air Flow H	m <sup>3</sup> /h	29500*
	External Static Pressure	Pa	40
Sound	Pressure Level C/H	dB(A)	65/66.5
	Power Level C/H	dB(A)	85.5/87
Unit(s)	Height x Width x Depth	mm	1830 x 2830 x 780
	Weight	kg	693
Pipe Connections	Refrigerant Base Charge	kg	11 x2
	Suction Gas Pipe Brazing	inch	1-3/8
	Discharge Pipe Brazing	inch	1-1/8
	Liquid Pipe Flare	inch	7/8
	Balance Pipe Flare	inch	3/8
	Equivalent Length	m	200
Maximum	Real Length	m	180
	Total Pipe Length (Liquid Line Real Length)	m	300
	Length To First Branch Height Difference Between Indoor Units ≤ 3 m	m	100
	Length To First Branch Height Difference Between Indoor Units > 3 m	m	85
	Equivalent Length Of Outdoor Unit Connecting Pipe	m	10
	Equivalent Length Between Branches	m	50
	Height Difference Outdoor Higher Than Indoor Units	m	70
	Height Difference Outdoor Lower Than Indoor Units	m	30
Electrical	Electrical Characteristic Running Current Cooling/Heating	A	41.73/35.61
	Power Supply	V/ph/Hz	380-415/3/50
	Suggested Fused Supply(s)	A	40 + 32

\*Combination combined value, see stand alone for individual data

\*All [Accessories](#) / [Controls](#)

Related items:

- [Full specification](#)
- [Dimensional drawing](#)
- [Connection diagram](#)
- [Noise curve data](#)

\*For further information see stand alone data

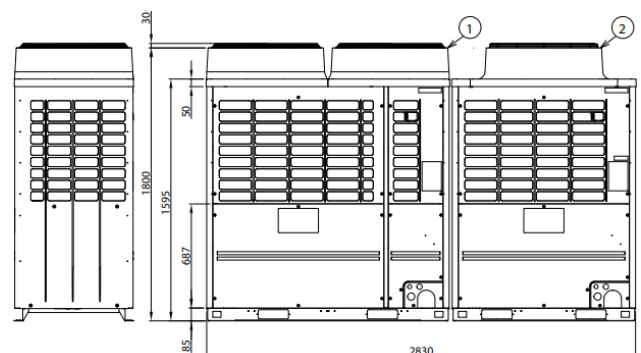

## VRF SHRMe R410a: **AP3216FT8P-UK**

### COMBINATIONS

- SHRMe can reach up to 1,000 meters maximum piping length.
- Surface area increased by 13% with 3-row heat exchanger enhancing efficiency.
- Toshiba's unique combination of twin rotary compressors and inverter driven control.
- Emphasis on driving excellence in energy savings and enhancement in applications.
- Unique Diamond Like Carbon Coating technology offers outstanding wear resistance.



Hi - Res Image 

### Performance & Outdoor Data

Model & Combination		AP3216FT8P-UK MAP1806FT8P-UK MAP1406FT8P-UK	
Capacity Range		HP	32
Maximum Number of Indoor Units		QTY	64
Cooling Capacity		kW	90.4
Heating Capacity		kW	101.5
Operating Range	Cooling	°C	-10.0 to 46.0
	Heating		-25.0 to 15.5
Cooling	Power Consumption	kW	27.80
	EER/SEER/Energy Efficiency Class (or nsc %)		3.25/5.82/229.8
Heating	Power Consumption	kW	24.40
	COP/SCOP/Energy Efficiency Class (or nsc(A) %)		3.70/3.59/140.6
Fan(s)	Standard Air Flow H	l/s	8195
	Standard Air Flow H	m <sup>3</sup> /h	29500
	External Static Pressure	Pa	40
Sound	Pressure Level C/H	dB(A)	65/66.5
	Power Level C/H	dB(A)	85.5/87
Unit(s)	Height x Width x Depth	mm	1830 x 2830 x 780
	Weight	kg	693
	Refrigerant Base Charge	kg	11 x2
Pipe Connections	Suction Gas Pipe Brazing	inch	1-3/8
	Discharge Pipe Brazing	inch	1-1/8
	Liquid Pipe Flare	inch	7/8
	Balance Pipe Flare	inch	3/8
	Equivalent Length	m	200
	Real Length	m	180
	Total Pipe Length (Liquid Line Real Length)	m	300
	Length To First Branch Height Difference Between Indoor Units ≤ 3 m	m	100
	Length To First Branch Height Difference Between Indoor Units > 3 m	m	85
	Equivalent Length Of Outdoor Unit Connecting Pipe	m	10
Maximum	Equivalent Length Between Branches	m	50
	Height Difference Outdoor Higher Than Indoor Units	m	70
	Height Difference Outdoor Lower Than Indoor Units	m	30
	Electrical Characteristic Running Current Cooling/Heating	A	43.62/38.28
	Power Supply	V/ph/Hz	380-415/3/50
	Suggested Fused Supply(s)	A	40 + 32

\*Combination combined value, see stand alone for individual data

\*All [Accessories](#) / [Controls](#)

Related items:

- [Full specification](#)
- [Dimensional drawing](#)
- [Connection diagram](#)
- [Noise curve data](#)



\*For further information see stand alone data

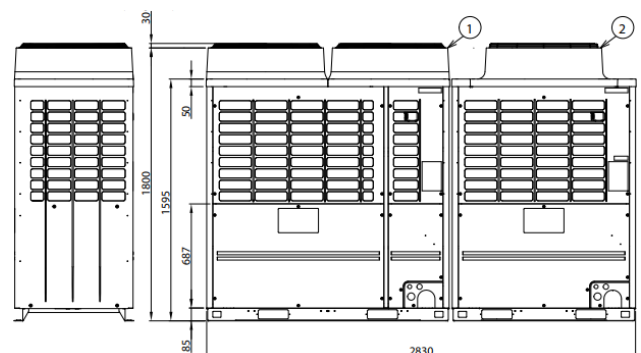

## VRF SHRMe R410a: **AP3416FT8P-UK**

### COMBINATIONS

- SHRMe can reach up to 1,000 meters maximum piping length.
- Surface area increased by 13% with 3-row heat exchanger enhancing efficiency.
- Toshiba's unique combination of twin rotary compressors and inverter driven control.
- Emphasis on driving excellence in energy savings and enhancement in applications.
- Unique Diamond Like Carbon Coating technology offers outstanding wear resistance.



Hi - Res Image 

### Performance & Outdoor Data

Model & Combination		AP3416FT8P-UK MAP1806FT8P-UK MAP1606FT8P-UK	
Capacity Range		HP	34
Maximum Number of Indoor Units		QTY	64
Cooling Capacity		kW	95.4
Heating Capacity		kW	106.5
Operating Range	Cooling	°C	-10.0 to 46.0
	Heating		-25.0 to 15.5
Cooling	Power Consumption	kW	29.90
	EER/SEER/Energy Efficiency Class (or nsc %)		3.19/5.86/231.4
Heating	Power Consumption	kW	25.90
	COP/SCOP/Energy Efficiency Class (or nsc(A) %)		3.68/3.55/139.0
Fan(s)	Standard Air Flow H	l/s	9612*
	Standard Air Flow H	m <sup>3</sup> /h	34600*
	External Static Pressure	Pa	40
Sound	Pressure Level C/H	dB(A)	64.5/65.5
	Power Level C/H	dB(A)	86.5/87.5
Unit(s)	Height x Width x Depth	mm	1830 x 3220 x 780
	Weight	kg	754
	Refrigerant Base Charge	kg	11 x2
Pipe Connections	Suction Gas Pipe Brazing	inch	1-3/8
	Discharge Pipe Brazing	inch	1-1/8
	Liquid Pipe Flare	inch	7/8
	Balance Pipe Flare	inch	3/8
	Equivalent Length	m	200
Maximum	Real Length	m	180
	Total Pipe Length (Liquid Line Real Length)	m	300
	Length To First Branch Height Difference Between Indoor Units ≤ 3 m	m	100
	Length To First Branch Height Difference Between Indoor Units > 3 m	m	85
	Equivalent Length Of Outdoor Unit Connecting Pipe	m	10
	Equivalent Length Between Branches	m	50
	Height Difference Outdoor Higher Than Indoor Units	m	70
	Height Difference Outdoor Lower Than Indoor Units	m	30
	Electrical Characteristic Running Current Cooling/Heating	A	46.91/40.63
	Power Supply	V/ph/Hz	380-415/3/50
Suggested Fused Supply(s)	A	40 x2	

\*Combination combined value, see stand alone for individual data

\*All [Accessories](#) / [Controls](#)

Related items:

- [Full specification](#)
- [Dimensional drawing](#)
- [Connection diagram](#)
- [Noise curve data](#)

\*For further information see stand alone data

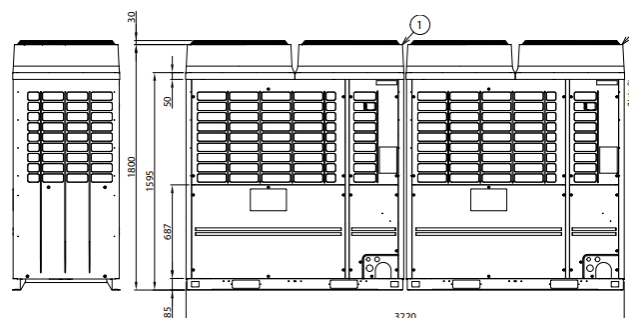

## VRF SHRMe R410a: **AP3616FT8P-UK**

### COMBINATIONS

- SHRMe can reach up to 1,000 meters maximum piping length.
- Surface area increased by 13% with 3-row heat exchanger enhancing efficiency.
- Toshiba's unique combination of twin rotary compressors and inverter driven control.
- Emphasis on driving excellence in energy savings and enhancement in applications.
- Unique Diamond Like Carbon Coating technology offers outstanding wear resistance.



Hi - Res Image

### Performance & Outdoor Data

Model & Combination		AP3616FT8P-UK	
		MAP1806FT8P-UK x 2	
Capacity Range		HP	36
Maximum Number of Indoor Units		QTY	64
Cooling Capacity		kW	100.8
Heating Capacity		kW	113.0
Operating Range	Cooling	°C	-10.0 to 46.0
	Heating		-25.0 to 15.5
Cooling	Power Consumption	kW	32.00
	EER/SEER/Energy Efficiency Class (or nsc %)		3.15/5.94/234.6
Heating	Power Consumption	kW	27.40
	COP/SCOP/Energy Efficiency Class (or nsc(A) %)		3.68/3.59/140.6
Fan(s)	Standard Air Flow H	l/s	9612*
	Standard Air Flow H	m <sup>3</sup> /h	34600*
Sound	External Static Pressure	Pa	40
	Pressure Level C/H	dB(A)	64.5/65.5
	Power Level C/H	dB(A)	86.5/87.5
Unit(s)	Height x Width x Depth	mm	1830 x 3220 x 780
	Weight	kg	754
Pipe Connections	Refrigerant Base Charge	kg	11 x2
	Suction Gas Pipe Brazing	inch	1-5/8
	Discharge Pipe Brazing	inch	1-3/8
	Liquid Pipe Flare	inch	7/8
	Balance Pipe Flare	inch	3/8
Maximum	Equivalent Length	m	200
	Real Length	m	180
	Total Pipe Length (Liquid Line Real Length)	m	1000
	Length To First Branch Height Difference Between Indoor Units ≤ 3 m	m	100
	Length To First Branch Height Difference Between Indoor Units > 3 m	m	85
	Equivalent Length Of Outdoor Unit Connecting Pipe	m	10
	Equivalent Length Between Branches	m	50
	Height Difference Outdoor Higher Than Indoor Units	m	70
	Height Difference Outdoor Lower Than Indoor Units	m	30
Electrical Characteristic Running Current Cooling/Heating	A	50.2/42.99	
Power Supply	V/ph/Hz	380-415/3/50	
Suggested Fused Supply(s)	A	40 x 2	

\*Combination combined value, see stand alone for individual data

\*All [Accessories](#) / [Controls](#)

Related items:

- [Full specification](#)
- [Dimensional drawing](#)
- [Connection diagram](#)
- [Noise curve data](#)

\*For further information see stand alone data

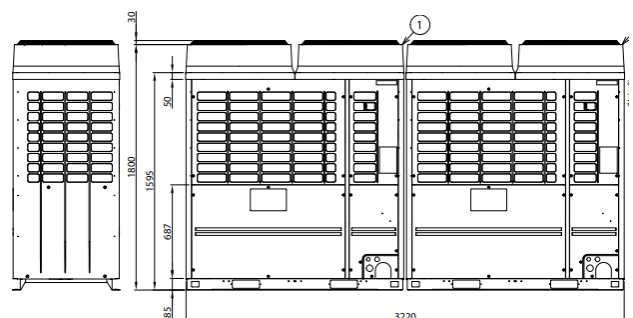

## VRF SHRMe R410a: **AP3816FT8P-UK**

### COMBINATIONS

- SHRMe can reach up to 1,000 meters maximum piping length.
- Surface area increased by 13% with 3-row heat exchanger enhancing efficiency.
- Toshiba's unique combination of twin rotary compressors and inverter driven control.
- Emphasis on driving excellence in energy savings and enhancement in applications.
- Unique Diamond Like Carbon Coating technology offers outstanding wear resistance.



Hi - Res Image

### Performance & Outdoor Data

Model & Combination		AP3816FT8P-UK MAP2006FT8P-UK MAP1806FT8P-UK	
Capacity Range		HP	38
Maximum Number of Indoor Units		QTY	64
Cooling Capacity		kW	106.4
Heating Capacity		kW	114.5
Operating Range	Cooling	°C	-10.0 to 46.0
	Heating		-25.0 to 15.5
Cooling	Power Consumption	kW	34.60
	EER/SEER/Energy Efficiency Class (or nsc %)		3.08/5.81/229.4
Heating	Power Consumption	kW	29.60
	COP/SCOP/Energy Efficiency Class (or nsc(A) %)		3.59/3.60/141.0
Fan(s)	Standard Air Flow H	l/s	9778*
	Standard Air Flow H	m <sup>3</sup> /h	35200*
	External Static Pressure	Pa	40
Sound	Pressure Level C/H	dB(A)	64.5/65.5
	Power Level C/H	dB(A)	86.5/87.5
Unit(s)	Height x Width x Depth	mm	1830 x 3220 x 780
	Weight	kg	754
Pipe Connections	Refrigerant Base Charge	kg	11 x2
	Suction Gas Pipe Brazing	inch	1-5/8
	Discharge Pipe Brazing	inch	1-3/8
	Liquid Pipe Flare	inch	7/8
	Balance Pipe Flare	inch	3/8
	Equivalent Length	m	200
Maximum	Real Length	m	180
	Total Pipe Length (Liquid Line Real Length)	m	1000
	Length To First Branch Height Difference Between Indoor Units ≤ 3 m	m	100
	Length To First Branch Height Difference Between Indoor Units > 3 m	m	85
	Equivalent Length Of Outdoor Unit Connecting Pipe	m	10
	Equivalent Length Between Branches	m	50
	Height Difference Outdoor Higher Than Indoor Units	m	70
	Height Difference Outdoor Lower Than Indoor Units	m	30
Electrical Characteristic Running Current Cooling/Heating		A	54.28/46.19
Power Supply		V/ph/Hz	380-415/3/50
Suggested Fused Supply(s)		A	50 + 40

\*Combination combined value, see stand alone for individual data

\*All [Accessories](#) / [Controls](#)

Related items:

- [Full specification](#)
- [Dimensional drawing](#)
- [Connection diagram](#)
- [Noise curve data](#)

\*For further information see stand alone data

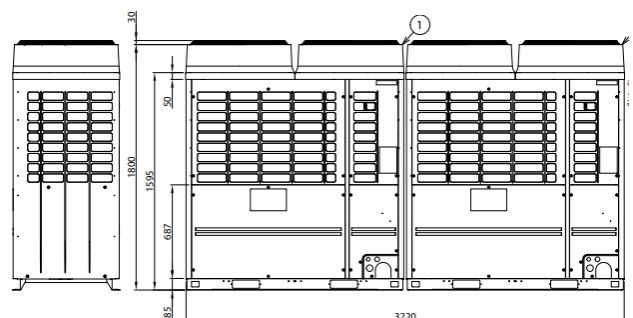

## VRF SHRMe R410a: **AP4016FT8P-UK**

### COMBINATIONS

- SHRMe can reach up to 1,000 meters maximum piping length.
- Surface area increased by 13% with 3-row heat exchanger enhancing efficiency.
- Toshiba's unique combination of twin rotary compressors and inverter driven control.
- Emphasis on driving excellence in energy savings and enhancement in applications.
- Unique Diamond Like Carbon Coating technology offers outstanding wear resistance.



Hi - Res Image

### Performance & Outdoor Data

Model & Combination		AP4016FT8P-UK	
		MAP2006FT8P-UK x 2	
Capacity Range		HP	40
Maximum Number of Indoor Units		QTY	64
Cooling Capacity		kW	112.0
Heating Capacity		kW	116.0
Operating Range	Cooling	°C	-10.0 to 46.0
	Heating		-25.0 to 15.5
Cooling	Power Consumption	kW	37.20
	EER/SEER/Energy Efficiency Class (or nsc %)		3.01/5.68/224.2
Heating	Power Consumption	kW	31.80
	COP/SCOP/Energy Efficiency Class (or nsc(A) %)		3.52/3.60/141.0
Fan(s)	Standard Air Flow H	l/s	9944*
	Standard Air Flow H	m <sup>3</sup> /h	35800*
	External Static Pressure	Pa	40
Sound	Pressure Level C/H	dB(A)	64.5/65.5
	Power Level C/H	dB(A)	86.5/87.5
Unit(s)	Height x Width x Depth	mm	1830 x 3220 x 780
	Weight	kg	754
Pipe Connections	Refrigerant Base Charge	kg	11 x2
	Suction Gas Pipe Brazing	inch	1-5/8
	Discharge Pipe Brazing	inch	1-3/8
	Liquid Pipe Flare	inch	7/8
	Balance Pipe Flare	inch	3/8
Maximum	Equivalent Length	m	200
	Real Length	m	180
	Total Pipe Length (Liquid Line Real Length)	m	1000
	Length To First Branch Height Difference Between Indoor Units ≤ 3 m	m	100
	Length To First Branch Height Difference Between Indoor Units > 3 m	m	85
	Equivalent Length Of Outdoor Unit Connecting Pipe	m	10
	Equivalent Length Between Branches	m	50
	Height Difference Outdoor Higher Than Indoor Units	m	70
	Height Difference Outdoor Lower Than Indoor Units	m	30
	Electrical Characteristic Running Current Cooling/Heating	A	58.36/49.35
Power Supply	V/ph/Hz	380-415/3/50	
Suggested Fused Supply(s)	A	50 x 2	

\*Combination combined value, see stand alone for individual data

\*All [Accessories](#) / [Controls](#)

Related items:

- [Full specification](#)
- [Dimensional drawing](#)
- [Connection diagram](#)
- [Noise curve data](#)



\*For further information see stand alone data

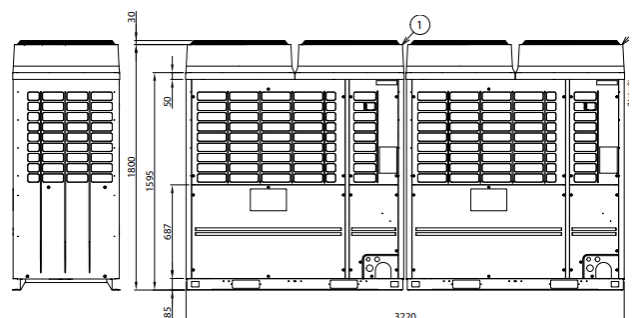

## VRF SHRMe R410a: **AP4216FT8P-UK**

### COMBINATIONS

- SHRMe can reach up to 1,000 meters maximum piping length.
- Surface area increased by 13% with 3-row heat exchanger enhancing efficiency.
- Toshiba's unique combination of twin rotary compressors and inverter driven control.
- Emphasis on driving excellence in energy savings and enhancement in applications.
- Unique Diamond Like Carbon Coating technology offers outstanding wear resistance.



Hi - Res Image 

### Performance & Outdoor Data

Model & Combination		AP4216FT8P-UK	
		MAP1406FT8P-UK x 3	
Capacity Range		HP	42
Maximum Number of Indoor Units		QTY	64
Cooling Capacity		kW	120.0
Heating Capacity		kW	135.0
Operating Range	Cooling	°C	-10.0 to 46.0
	Heating		-25.0 to 15.5
Cooling	Power Consumption	kW	38.10
	EER/SEER/Energy Efficiency Class (or nsc %)		3.15/5.67/223.8
Heating	Power Consumption	kW	31.50
	COP/SCOP/Energy Efficiency Class (or nsc(A) %)		3.81/3.57/139.8
Fan(s)	Standard Air Flow H	l/s	10167*
	Standard Air Flow H	m3/h	36600*
	External Static Pressure	Pa	40
Sound	Pressure Level C/H	dB(A)	67/69
	Power Level C/H	dB(A)	86/88
Unit(s)	Height x Width x Depth	mm	1830 x 3670 x 780
	Weight	kg	948
	Refrigerant Base Charge	kg	11 x3
Pipe Connections	Suction Gas Pipe Brazing	inch	1-5/8
	Discharge Pipe Brazing	inch	1-3/8
	Liquid Pipe Flare	inch	7/8
	Balance Pipe Flare	inch	3/8
	Equivalent Length	m	200
	Real Length	m	180
	Total Pipe Length (Liquid Line Real Length)	m	1000
Maximum	Length To First Branch Height Difference Between Indoor Units ≤ 3 m	m	100
	Length To First Branch Height Difference Between Indoor Units > 3 m	m	85
	Equivalent Length Of Outdoor Unit Connecting Pipe	m	10
	Equivalent Length Between Branches	m	50
	Height Difference Outdoor Higher Than Indoor Units	m	70
	Height Difference Outdoor Lower Than Indoor Units	m	30
	Electrical Characteristic Running Current Cooling/Heating	A	59.8/49.4
	Power Supply	V/ph/Hz	380-415/3/50
	Suggested Fused Supply(s)	A	32 x 3

\*Combination combined value, see stand alone for individual data

\*All [Accessories](#) / [Controls](#)

Related items:

- [Full specification](#)
- [Dimensional drawing](#)
- [Connection diagram](#)
- [Noise curve data](#)

\*For further information see stand alone data

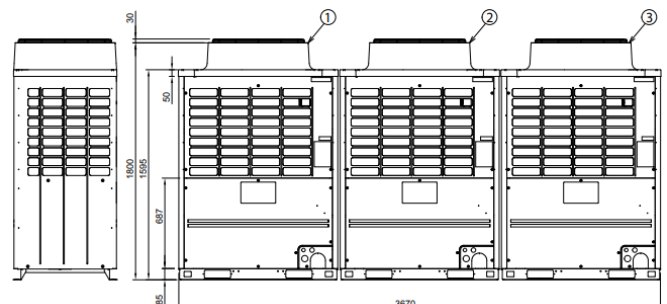



## VRF SHRM<sub>e</sub> R410a: AP1626FT8P-UK

COMBINATIONS — HIGH EFFICIENCY

- SHRM-e can reach up to 1,000 meters maximum piping length.
- Surface area increased by 13% with 3-row heat exchanger enhancing efficiency.
- Toshiba's unique combination of twin rotary compressors and inverter driven control.
- Emphasis on driving excellence in energy savings and enhancement in applications.
- Unique Diamond Like Carbon Coating technology offers outstanding wear resistance.



Hi - Res Image

### Performance & Outdoor Data

Model & Combination		AP1626FT8P-UK	
		MAP0806FT8P-UK x 2	
Capacity Range		HP	16
Maximum Number of Indoor Units		QTY	36
Cooling Capacity		kW	44.8
Heating Capacity		kW	50.0
Operating Range	Cooling	°C	-10.0 to 46.0
	Heating		-25.0 to 15.5
Cooling	Power Consumption	kW	12.13
	EER/SEER/Energy Efficiency Class (or nsc %)		3.76/6.19/244.6
Heating	Power Consumption	kW	10.77
	COP/SCOP/Energy Efficiency Class (or nsc(A) %)		4.14/3.64/142.6
Fan(s)	Standard Air Flow H	l/s	5388*
	Standard Air Flow H	m3/h	19400*
	External Static Pressure	Pa	60
Sound	Pressure Level C/H	dB(A)	62/64
	Power Level C/H	dB(A)	83/85
Unit(s)	Height x Width x Depth	mm	1830 x 2000 x 780
	Weight	kg	526
Pipe Connections	Refrigerant Base Charge	kg	11 x2
	Suction Gas Pipe Brazing	inch	1-1/8
	Discharge Pipe Brazing	inch	7/8
	Liquid Pipe Flare	inch	3/4
	Balance Pipe Flare	inch	3/8
Maximum	Equivalent Length	m	200
	Real Length	m	180
	Total Pipe Length (Liquid Line Real Length)	m	300
	Length To First Branch Height Difference Between Indoor Units ≤ 3 m	m	100
	Length To First Branch Height Difference Between Indoor Units > 3 m	m	85
	Equivalent Length Of Outdoor Unit Connecting Pipe	m	10
	Equivalent Length Between Branches	m	50
	Height Difference Outdoor Higher Than Indoor Units	m	70
	Height Difference Outdoor Lower Than Indoor Units	m	30
	Electrical Characteristic Running Current Cooling/Heating	A	18.88/17.14
Power Supply	V/ph/Hz	380-415/3/50	
Suggested Fused Supply(s)	A	20 x2	

\*Combination combined value, see stand alone for individual data

\*All [Accessories](#) / [Controls](#)



\*For further information see stand alone data

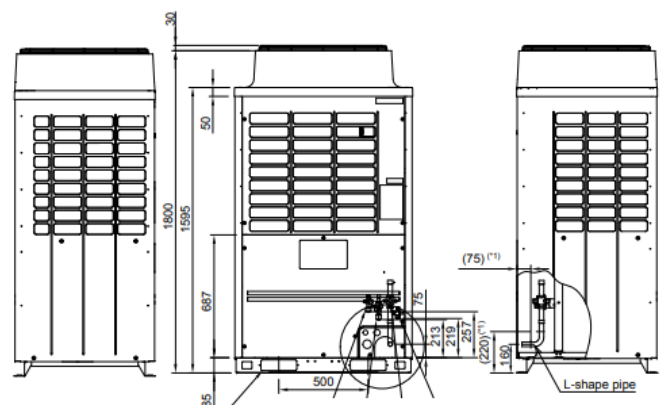

### VRF SHRMe R410a: **AP1826FT8P-UK**

COMBINATIONS — HIGH EFFICIENCY

- SHRMe can reach up to 1,000 meters maximum piping length.
- Surface area increased by 13% with 3-row heat exchanger enhancing efficiency.
- Toshiba's unique combination of twin rotary compressors and inverter driven control.
- Emphasis on driving excellence in energy savings and enhancement in applications.
- Unique Diamond Like Carbon Coating technology offers outstanding wear resistance.



Hi - Res Image

#### Performance & Outdoor Data

Model & Combination		AP1826FT8P-UK MAP0806FT8P-UK MAP1006FT8P-UK	
Capacity Range		HP	18
Maximum Number of Indoor Units		QTY	40
Cooling Capacity		kW	50.4
Heating Capacity		kW	56.5
Operating Range	Cooling	°C	-10.0 to 46.0
	Heating		-25.0 to 15.5
Cooling	Power Consumption	kW	14.18
	EER/SEER/Energy Efficiency Class (or nsc %)		3.64/6.16/243.0
Heating	Power Consumption	kW	12.28
	COP/SCOP/Energy Efficiency Class (or nsc(A) %)		4.06/3.59/140.4
Fan(s)	Standard Air Flow H	l/s	5388*
	Standard Air Flow H	m <sup>3</sup> /h	19400*
	External Static Pressure	Pa	60
Sound	Pressure Level C/H	dB(A)	62/64
	Power Level C/H	dB(A)	83/85
Unit(s)	Height x Width x Depth	mm	1830 x 2000 x 780
	Weight	kg	526
Pipe Connections	Refrigerant Base Charge	kg	11 x2
	Suction Gas Pipe Brazing	inch	1-1/8
	Discharge Pipe Brazing	inch	7/8
	Liquid Pipe Flare	inch	3/4
	Balance Pipe Flare	inch	3/8
	Equivalent Length	m	200
Maximum	Real Length	m	180
	Total Pipe Length (Liquid Line Real Length)	m	300
	Length To First Branch Height Difference Between Indoor Units ≤ 3 m	m	100
	Length To First Branch Height Difference Between Indoor Units > 3 m	m	85
	Equivalent Length Of Outdoor Unit Connecting Pipe	m	10
	Equivalent Length Between Branches	m	50
	Height Difference Outdoor Higher Than Indoor Units	m	70
	Height Difference Outdoor Lower Than Indoor Units	m	30
	Electrical Characteristic Running Current Cooling/Heating	A	21.93/19.63
	Power Supply	V/ph/Hz	380-415/3/50
Suggested Fused Supply(s)		A	20 + 25

\*Combination combined value, see stand alone for individual data

\*All [Accessories](#) / [Controls](#)



\*For further information see stand alone data

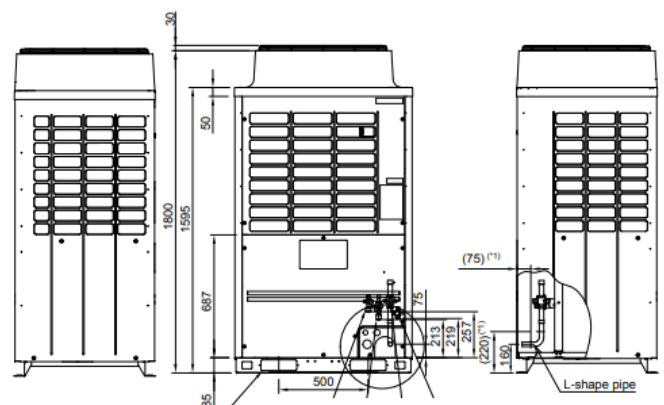

## VRF SHRMe R410a: AP2026FT8P-UK

COMBINATIONS — HIGH EFFICIENCY

- SHRMe can reach up to 1,000 meters maximum piping length.
- Surface area increased by 13% with 3-row heat exchanger enhancing efficiency.
- Toshiba's unique combination of twin rotary compressors and inverter driven control.
- Emphasis on driving excellence in energy savings and enhancement in applications.
- Unique Diamond Like Carbon Coating technology offers outstanding wear resistance.



Hi - Res Image

### Performance & Outdoor Data

Model & Combination		AP2026FT8P-UK	
		MAP1006FT8P-UK x 2	
Capacity Range		HP	20
Maximum Number of Indoor Units		QTY	41
Cooling Capacity		kW	56.0
Heating Capacity		kW	63.0
Operating Range	Cooling	°C	-10.0 to 46.0
	Heating		-25.0 to 15.5
Cooling	Power Consumption	kW	16.23
	EER/SEER/Energy Efficiency Class (or nsc %)		3.51/6.13/242.2
Heating	Power Consumption	kW	13.79
	COP/SCOP/Energy Efficiency Class (or nsc(A) %)		3.97/3.54/138.6
Fan(s)	Standard Air Flow H	l/s	5388*
	Standard Air Flow H	m <sup>3</sup> /h	19400*
	External Static Pressure	Pa	50
Sound	Pressure Level C/H	dB(A)	62/64
	Power Level C/H	dB(A)	83/85
Unit(s)	Height x Width x Depth	mm	1830 x 2000 x 780
	Weight	kg	526
	Refrigerant Base Charge	kg	11 x 2
Pipe Connections	Suction Gas Pipe Brazing	inch	1-1/8
	Discharge Pipe Brazing	inch	7/8
	Liquid Pipe Flare	inch	3/4
	Balance Pipe Flare	inch	3/8
Maximum	Equivalent Length	m	200
	Real Length	m	180
	Total Pipe Length (Liquid Line Real Length)	m	300
	Length To First Branch Height Difference Between Indoor Units ≤ 3 m	m	100
	Length To First Branch Height Difference Between Indoor Units > 3 m	m	85
	Equivalent Length Of Outdoor Unit Connecting Pipe	m	10
	Equivalent Length Between Branches	m	50
	Height Difference Outdoor Higher Than Indoor Units	m	70
	Height Difference Outdoor Lower Than Indoor Units	m	30
	Electrical Characteristic Running Current Cooling/Heating	A	24.98/22.12
	Power Supply	V/ph/Hz	380-415/3/50
	Suggested Fused Supply(s)	A	25 x 2

\*Combination combined value, see stand alone for individual data

\*All [Accessories](#) / [Controls](#)



\*For further information see stand alone data

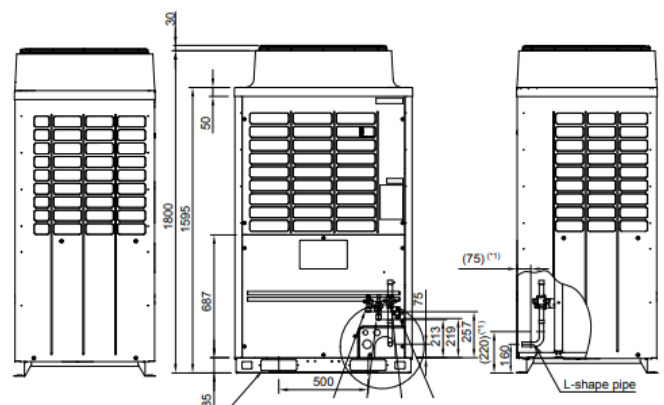

## VRF SHRMe R410a: AP2426FT8P-UK

COMBINATIONS — HIGH EFFICIENCY

- SHRMe can reach up to 1,000 meters maximum piping length.
- Surface area increased by 13% with 3-row heat exchanger enhancing efficiency.
- Toshiba's unique combination of twin rotary compressors and inverter driven control.
- Emphasis on driving excellence in energy savings and enhancement in applications.
- Unique Diamond Like Carbon Coating technology offers outstanding wear resistance.



Hi - Res Image

### Performance & Outdoor Data

Model & Combination		AP2426FT8P-UK MAP0806FT8P-UK x 3	
Capacity Range		HP	24
Maximum Number of Indoor Units		QTY	54
Cooling Capacity		kW	67.2
Heating Capacity		kW	75.0
Operating Range	Cooling	°C	-10.0 to 46.0
	Heating		-25.0 to 15.5
Cooling	Power Consumption	kW	18.20
	EER/SEER/Energy Efficiency Class (or nsc %)		3.76/6.19/244.6
Heating	Power Consumption	kW	16.15
	COP/SCOP/Energy Efficiency Class (or nsc(A) %)		4.14/3.64/142.6
Fan(s)	Standard Air Flow H	l/s	8082*
	Standard Air Flow H	m3/h	29100*
	External Static Pressure	Pa	60
Sound	Pressure Level C/H	dB(A)	62/64
	Power Level C/H	dB(A)	83/85
Unit(s)	Height x Width x Depth	mm	1830 x 3010 x 780
	Weight	kg	789
Pipe Connections	Refrigerant Base Charge	kg	11 x3
	Suction Gas Pipe Brazing	inch	1-3/8
	Discharge Pipe Brazing	inch	1-1/8
	Liquid Pipe Flare	inch	3/4
	Balance Pipe Flare	inch	3/8
Maximum	Equivalent Length	m	200
	Real Length	m	180
	Total Pipe Length (Liquid Line Real Length)	m	300
	Length To First Branch Height Difference Between Indoor Units ≤ 3 m	m	100
	Length To First Branch Height Difference Between Indoor Units > 3 m	m	85
	Equivalent Length Of Outdoor Unit Connecting Pipe	m	10
	Equivalent Length Between Branches	m	50
	Height Difference Outdoor Higher Than Indoor Units	m	70
	Height Difference Outdoor Lower Than Indoor Units	m	30
	Electrical Characteristic Running Current Cooling/Heating	A	28.32/25.71
Power Supply	V/ph/Hz	380-415/3/50	
Suggested Fused Supply(s)	A	20 x3	

\*Combination combined value, see stand alone for individual data

\*All [Accessories](#) / [Controls](#)



\*For further information see stand alone data

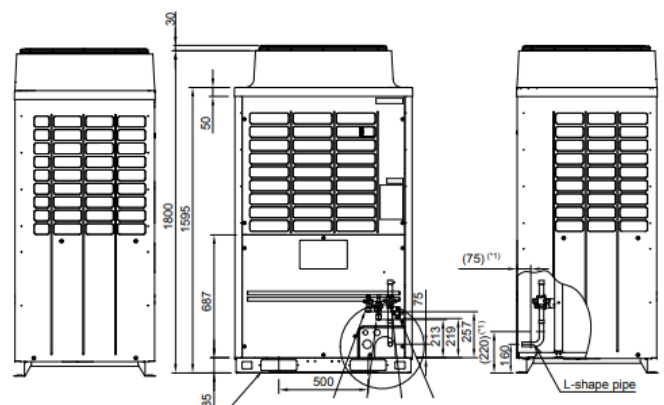

## VRF SHRMe R410a: AP2626FT8P-UK

COMBINATIONS — HIGH EFFICIENCY

- SHRMe can reach up to 1,000 meters maximum piping length.
- Surface area increased by 13% with 3-row heat exchanger enhancing efficiency.
- Toshiba's unique combination of twin rotary compressors and inverter driven control.
- Emphasis on driving excellence in energy savings and enhancement in applications.
- Unique Diamond Like Carbon Coating technology offers outstanding wear resistance.



Hi - Res Image

### Performance & Outdoor Data

Model & Combination		AP2626FT8P-UK MAP0806FT8P-UK x 2 MAP1006FT8P-UK	
Capacity Range		HP	26
Maximum Number of Indoor Units		QTY	58
Cooling Capacity		kW	72.8
Heating Capacity		kW	81.5
Operating Range	Cooling	°C	-10.0 to 46.0
	Heating		-25.0 to 15.5
Cooling	Power Consumption	kW	20.25
	EER/SEER/Energy Efficiency Class (or nsc %)		3.68/6.17/243.4
Heating	Power Consumption	kW	17.66
	COP/SCOP/Energy Efficiency Class (or nsc(A) %)		4.08/3.61/141.0
Fan(s)	Standard Air Flow H	l/s	8082*
	Standard Air Flow H	m <sup>3</sup> /h	29100*
	External Static Pressure	Pa	50
Sound	Pressure Level C/H	dB(A)	62/64
	Power Level C/H	dB(A)	83/85
Unit(s)	Height x Width x Depth	mm	1830 x 3010 x 780
	Weight	kg	789
	Refrigerant Base Charge	kg	11 x3
Pipe Connections	Suction Gas Pipe Brazing	inch	1-3/8
	Discharge Pipe Brazing	inch	1-1/8
	Liquid Pipe Flare	inch	7/8
	Balance Pipe Flare	inch	3/8
	Equivalent Length	m	200
	Real Length	m	180
Maximum	Total Pipe Length (Liquid Line Real Length)	m	300
	Length To First Branch Height Difference Between Indoor Units ≤ 3 m	m	100
	Length To First Branch Height Difference Between Indoor Units > 3 m	m	85
	Equivalent Length Of Outdoor Unit Connecting Pipe	m	10
	Equivalent Length Between Branches	m	50
	Height Difference Outdoor Higher Than Indoor Units	m	70
	Height Difference Outdoor Lower Than Indoor Units	m	30
	Electrical Characteristic Running Current Cooling/Heating	A	31.37/28.2
Power Supply	V/ph/Hz	380-415/3/50	
Suggested Fused Supply(s)	A	20 x 2 + 25	

\*Combination combined value, see stand alone for individual data

\*All [Accessories](#) / [Controls](#)

\*For further information see stand alone data

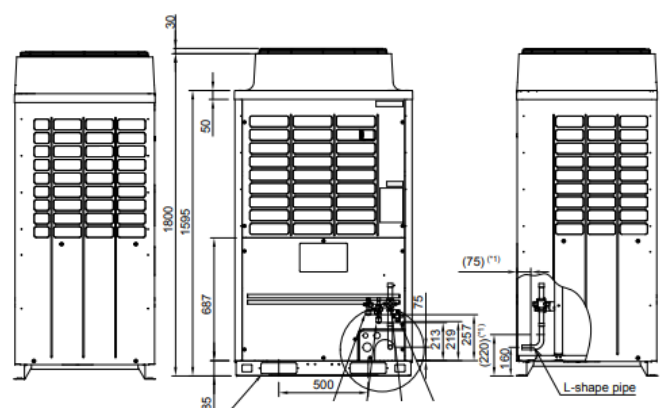

## VRF SHRMe R410a: AP2826FT8P-UK

COMBINATIONS — HIGH EFFICIENCY

- SHRMe can reach up to 1,000 meters maximum piping length.
- Surface area increased by 13% with 3-row heat exchanger enhancing efficiency.
- Toshiba's unique combination of twin rotary compressors and inverter driven control.
- Emphasis on driving excellence in energy savings and enhancement in applications.
- Unique Diamond Like Carbon Coating technology offers outstanding wear resistance.



Hi - Res Image

### Performance & Outdoor Data

Model & Combination		AP2826FT8P-UK MAP0806FT8P-UK MAP1006FT8P-UK x 2	
Capacity Range		HP	28
Maximum Number of Indoor Units		QTY	63
Cooling Capacity		kW	78.4
Heating Capacity		kW	88.0
Operating Range	Cooling	°C	-10.0 to 46.0
	Heating		-25.0 to 15.5
Cooling	Power Consumption	kW	22.30
	EER/SEER/Energy Efficiency Class (or nsc %)		3.68/6.15/242.8
Heating	Power Consumption	kW	19.17
	COP/SCOP/Energy Efficiency Class (or nsc(A) %)		4.08/3.57/139.6
Fan(s)	Standard Air Flow H	l/s	8082*
	Standard Air Flow H	m <sup>3</sup> /h	29100*
	External Static Pressure	Pa	50
Sound	Pressure Level C/H	dB(A)	62/64
	Power Level C/H	dB(A)	83/85
Unit(s)	Height x Width x Depth	mm	1830 x 3010 x 780
	Weight	kg	789
Pipe Connections	Refrigerant Base Charge	kg	11 x3
	Suction Gas Pipe Brazing	inch	1-3/8
	Discharge Pipe Brazing	inch	1-1/8
	Liquid Pipe Flare	inch	7/8
	Balance Pipe Flare	inch	3/8
Maximum	Equivalent Length	m	200
	Real Length	m	180
	Total Pipe Length (Liquid Line Real Length)	m	300
	Length To First Branch Height Difference Between Indoor Units ≤ 3 m	m	100
	Length To First Branch Height Difference Between Indoor Units > 3 m	m	85
	Equivalent Length Of Outdoor Unit Connecting Pipe	m	10
	Equivalent Length Between Branches	m	50
	Height Difference Outdoor Higher Than Indoor Units	m	70
	Height Difference Outdoor Lower Than Indoor Units	m	30
	Electrical Characteristic Running Current Cooling/Heating	A	34.42/30.69
Power Supply	V/ph/Hz	380-415/3/50	
Suggested Fused Supply(s)	A	20 + 25 x2	

\*Combination combined value, see stand alone for individual data

\*All [Accessories](#) / [Controls](#)



\*For further information see stand alone data

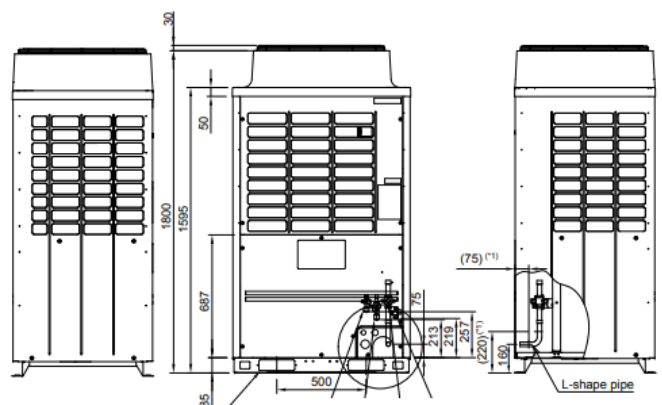

## VRF SHRMe R410a: AP3026FT8P-UK

COMBINATIONS — HIGH EFFICIENCY

- SHRMe can reach up to 1,000 meters maximum piping length.
- Surface area increased by 13% with 3-row heat exchanger enhancing efficiency.
- Toshiba's unique combination of twin rotary compressors and inverter driven control.
- Emphasis on driving excellence in energy savings and enhancement in applications.
- Unique Diamond Like Carbon Coating technology offers outstanding wear resistance.



Hi - Res Image

### Performance & Outdoor Data

Model & Combination		AP3026FT8P-UK	
		MAP1006FT8P-UK x 3	
Capacity Range		HP	30
Maximum Number of Indoor Units		QTY	64
Cooling Capacity		kW	84.0
Heating Capacity		kW	94.5
Operating Range	Cooling	°C	-10.0 to 46.0
	Heating		-25.0 to 15.5
Cooling	Power Consumption	kW	23.9
	EER/SEER/Energy Efficiency Class (or nsc %)		3.51/6.13/242.2
Heating	Power Consumption	kW	21.2
	COP/SCOP/Energy Efficiency Class (or nsc(A) %)		3.97/3.54/138.6
Fan(s)	Standard Air Flow H	l/s	8082
	Standard Air Flow H	m3/h	29100
	External Static Pressure	Pa	50
Sound	Pressure Level C/H	dB(A)	62/64
	Power Level C/H	dB(A)	83/85
Unit(s)	Height x Width x Depth	mm	1830 x 3010 x 780
	Weight	kg	789
Pipe Connections	Refrigerant Base Charge	kg	11 x3
	Suction Gas Pipe Brazing	inch	1-3/8
	Discharge Pipe Brazing	inch	1-1/8
	Liquid Pipe Flare	inch	7/8
	Balance Pipe Flare	inch	3/8
Maximum	Equivalent Length	m	200
	Real Length	m	180
	Total Pipe Length (Liquid Line Real Length)	m	300
	Length To First Branch Height Difference Between Indoor Units ≤ 3 m	m	100
	Length To First Branch Height Difference Between Indoor Units > 3 m	m	85
	Equivalent Length Of Outdoor Unit Connecting Pipe	m	10
	Equivalent Length Between Branches	m	50
	Height Difference Outdoor Higher Than Indoor Units	m	70
	Height Difference Outdoor Lower Than Indoor Units	m	30
	Electrical Characteristic Running Current Cooling/Heating	A	37.47/33.18
Power Supply	V/ph/Hz	380-415/3/50	
Suggested Fused Supply(s)	A	25 x3	

\*Combination combined value, see stand alone for individual data

\*All [Accessories](#) / [Controls](#)



\*For further information see stand alone data

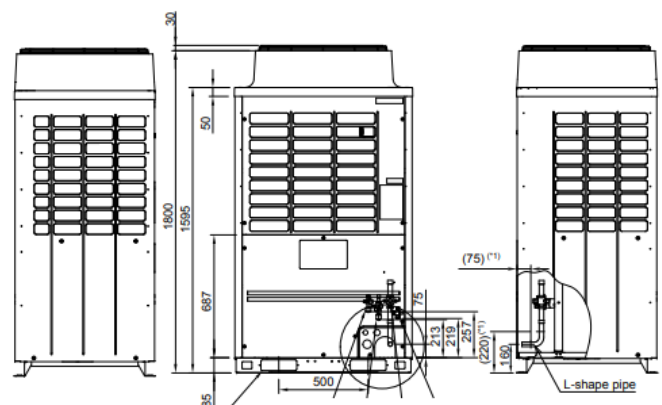

## VRF SHRMe R410a: **AP3626FT8P-UK**

COMBINATIONS — HIGH EFFICIENCY

- SHRMe can reach up to 1,000 meters maximum piping length.
- Surface area increased by 13% with 3-row heat exchanger enhancing efficiency.
- Toshiba's unique combination of twin rotary compressors and inverter driven control.
- Emphasis on driving excellence in energy savings and enhancement in applications.
- Unique Diamond Like Carbon Coating technology offers outstanding wear resistance.



Hi - Res Image

### Performance & Outdoor Data

Model & Combination		AP3626FT8P-UK MAP1206FT8P-UK x 3	
Capacity Range		HP	36
Maximum Number of Indoor Units		QTY	64
Cooling Capacity		kW	100.5
Heating Capacity		kW	112.5
Operating Range	Cooling	°C	-10.0 to 46.0
	Heating		-25.0 to 15.5
Cooling	Power Consumption	kW	29.3
	EER/SEER/Energy Efficiency Class (or nsc %)		3.43/6.02/237.8
Heating	Power Consumption	kW	26.1
	COP/SCOP/Energy Efficiency Class (or nsc(A) %)		3.85/3.71/145.4
Fan(s)	Standard Air Flow H	l/s	10167*
	Standard Air Flow H	m3/h	36600*
	External Static Pressure	Pa	50
Sound	Pressure Level C/H	dB(A)	63/65
	Power Level C/H	dB(A)	83/85
Unit(s)	Height x Width x Depth	mm	1830 x 3670 x 780
	Weight	kg	948
	Refrigerant Base Charge	kg	11 x3
Pipe Connections	Suction Gas Pipe Brazing	inch	1-5/8
	Discharge Pipe Brazing	inch	1-3/8
	Liquid Pipe Flare	inch	7/8
	Balance Pipe Flare	inch	3/8
	Equivalent Length	m	200
	Real Length	m	180
	Total Pipe Length (Liquid Line Real Length)	m	1000
Maximum	Length To First Branch Height Difference Between Indoor Units ≤ 3 m	m	100
	Length To First Branch Height Difference Between Indoor Units > 3 m	m	85
	Equivalent Length Of Outdoor Unit Connecting Pipe	m	10
	Equivalent Length Between Branches	m	50
	Height Difference Outdoor Higher Than Indoor Units	m	70
	Height Difference Outdoor Lower Than Indoor Units	m	30
	Electrical Characteristic Running Current Cooling/Heating	A	46.38/41.40
	Power Supply	V/ph/Hz	380-415/3/50
	Suggested Fused Supply(s)	A	25 x3

\*Combination combined value, see stand alone for individual data

\*All [Accessories](#) / [Controls](#)



\*For further information see stand alone data

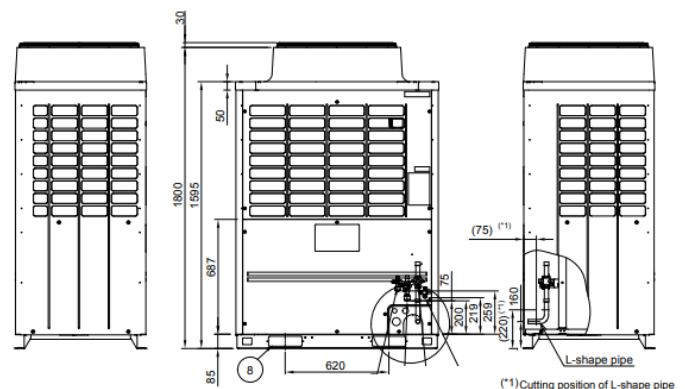



## VRF SHRMe R410a: **AP4226FT8P-UK**

**COMBINATIONS** — **HIGH EFFICIENCY**

- SHRMe can reach up to 1,000 meters maximum piping length.
- Surface area increased by 13% with 3-row heat exchanger enhancing efficiency.
- Toshiba's unique combination of twin rotary compressors and inverter driven control.
- Emphasis on driving excellence in energy savings and enhancement in applications.
- Unique Diamond Like Carbon Coating technology offers outstanding wear resistance.



Hi - Res Image

### Performance & Outdoor Data

Model & Combination		AP4226FT8P-UK MAP1606FT8P-UK x 2 MAP1006FT8P-UK	
Capacity Range		HP	42
Maximum Number of Indoor Units		QTY	64
Cooling Capacity		kW	118.0
Heating Capacity		kW	131.5
Operating Range	Cooling	°C	-10.0 to 46.0
	Heating		-25.0 to 15.5
Cooling	Power Consumption	kW	35.8
	EER/SEER/Energy Efficiency Class (or nsc %)		3.32/5.90/232.4
Heating	Power Consumption	kW	31.5
	COP/SCOP/Energy Efficiency Class (or nsc(A) %)		3.78/3.52/137.6
Fan(s)	Standard Air Flow H	l/s	12306*
	Standard Air Flow H	m3/h	44300*
	External Static Pressure	Pa	40
Sound	Pressure Level C/H	dB(A)	63/64.5
	Power Level C/H	dB(A)	85/86
Unit(s)	Height x Width x Depth	mm	1830 x 4230 x 780
	Weight	kg	1017
Pipe Connections	Refrigerant Base Charge	kg	11 x3
	Suction Gas Pipe Brazing	inch	1-5/8
	Discharge Pipe Brazing	inch	1-3/8
	Liquid Pipe Flare	inch	7/8
Maximum	Balance Pipe Flare	inch	3/8
	Equivalent Length	m	200
	Real Length	m	180
	Total Pipe Length (Liquid Line Real Length)	m	1000
	Length To First Branch Height Difference Between Indoor Units ≤ 3 m	m	100
	Length To First Branch Height Difference Between Indoor Units > 3 m	m	85
	Equivalent Length Of Outdoor Unit Connecting Pipe	m	10
	Equivalent Length Between Branches	m	50
	Height Difference Outdoor Higher Than Indoor Units	m	70
	Height Difference Outdoor Lower Than Indoor Units	m	30
Electrical Characteristic Running Current Cooling/Heating	A	56.11/49.34	
Power Supply	V/ph/Hz	380-415/3/50	
Suggested Fused Supply(s)	A	40 x2 + 25	

\*Combination combined value, see stand alone for individual data

\*All [Accessories](#) / [Controls](#)



\*For further information see stand alone data

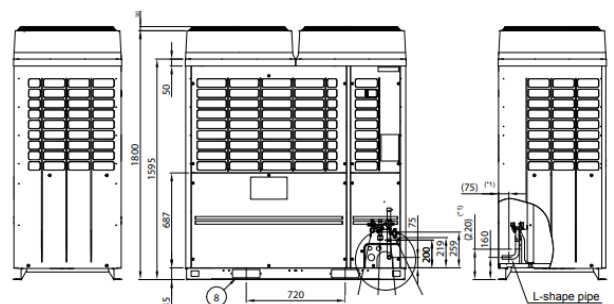

Image for stand alone MAP1606FT8P-UK

## VRF SHRMe R410a: Single flow selector boxes (3 series):

Flow Selector Boxes: The Toshiba FS Box is the smallest and lightest heat recovery box on the market, offering exceptional performance and easy maintenance in a compact and quiet design.



Hi - Res Image



Flow Selector Unit (Series 3)	RBM-	Y1123FE	Y1803FE	Y2803FE
Height x Width x Depth	mm	190 x 490 x 160	190 x 490 x 160	200 x 640 x 200
Weight	kg	5	5	8
Standard 5 Core Control Cable Max. Length	m	6	6	6
Standard 3 Core Power Cable Max. Length	m	6	6	6
Optional Accessory Combined Control/Power Cable Max. Length	m	15	15	15
Power Supply From Local or Group Indoor Unit	V/ph/Hz	220-240/1/50	220-240/1/50	220-240/1/50

Single Unit Connection For Flow Selector						
MM*-UP***		007 to 012	015 to 018	024 to 030	036 to 056	072 to 096
Indoor Unit Side Gas Pipe	inch	3/8	1/2	5/8	5/8	7/8
Indoor Unit Side Liquid Pipe	inch	1/4	1/4	3/8	3/8	1/2
Outdoor Unit Side Suction Gas Pipe	inch	5/8	5/8	5/8	5/8	7/8
Outdoor Unit Side Discharge Gas Pipe	inch	1/2	1/2	1/2	1/2	3/4
Outdoor Unit Side Liquid Pipe	inch	3/8	3/8	3/8	3/8	1/2
Max. Pipe Length To Indoor Unit	m	15	15	15	15	15

Multi Unit Connection For Flow Selector		Less than 4 hp	4 hp or more Less than 6.4 hp	6.4 hp or more Less than 10 hp
Indoor unit capacity code				
Indoor Unit Side Gas Pipe	inch	5/8	5/8	7/8
Indoor Unit Side Liquid Pipe	inch	3/8	3/8	1/2
Outdoor Unit Side Suction Gas Pipe	inch	5/8	5/8	7/8
Outdoor Unit Side Discharge Gas Pipe	inch	1/2	1/2	3/4
Outdoor Unit Side Liquid Pipe	inch	3/8	3/8	1/2
Max. Connectable Indoor Units		5	8	8
Max. Total Pipe Length	m	30	30	30
Max. Height Difference Between Indoor Units	m	±0.5	±0.5	±0.5

\*All [Accessories](#) / [Controls](#)

Related items - Y1123FE:

- [Full specification](#)
- [BIM files](#)
- [CAD files](#)
- [Dimensional drawing](#)
- [Wiring diagram](#)
- [Installation manual](#)



Related items - Y1803FE:

- [Full specification](#)
- [BIM files](#)
- [CAD files](#)
- [Dimensional drawing](#)
- [Wiring diagram](#)
- [Installation manual](#)



Related items - Y2803FE:

- [Full specification](#)
- [BIM files](#)
- [CAD files](#)
- [Dimensional drawing](#)
- [Wiring diagram](#)
- [Installation manual](#)



## VRF SHRMe R410a: Single flow selector boxes (4 series):

Flow Selector Boxes: The Toshiba FS Box is the smallest and lightest heat recovery box on the market, offering exceptional performance and easy maintenance in a compact and quiet design.

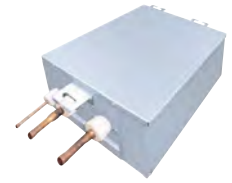

Hi - Res Image



Flow Selector Unit (Series 4)	RBM-	Y1124FE	Y1804FE	Y2804FE
Height x Width x Depth	mm	180 x 425 x 300	180 x 425 x 300	180 x 495 x 350
Weight	kg	11	11	16
Standard 5 Core Control Cable Max. Length	m	-	-	-
Standard 3 Core Power Cable Max. Length	m	-	-	-
Optional Accessory Combined Control/Power Cable Max. Length	m	-	-	-
Power Supply From Local or Group Indoor Unit	V/ph/Hz	220-240/1/50	220-240/1/50	220-240/1/50

Single Unit Connection For Flow Selector		005 to 012	015 to 018	024 to 030	036 to 056	072 to 096
MM*-UP***						
Indoor Unit Side Gas Pipe	inch	3/8	1/2	5/8	5/8	7/8
Indoor Unit Side Liquid Pipe	inch	1/4	1/4	3/8	3/8	1/2
Outdoor Unit Side Suction Gas Pipe	inch	5/8	5/8	5/8	5/8	7/8
Outdoor Unit Side Discharge Gas Pipe	inch	1/2	1/2	1/2	1/2	3/4
Outdoor Unit Side Liquid Pipe	inch	3/8	3/8	3/8	3/8	1/2
Max. Pipe Length To Indoor Unit	m	50	50	50	50	50

Multi Unit Connection For Flow Selector		Less than 4 hp	4 hp or more Less than 6.4 hp	6.4 hp or more Less than 10 hp
Indoor unit capacity code				
Indoor Unit Side Gas Pipe	inch	5/8	5/8	7/8
Indoor Unit Side Liquid Pipe	inch	3/8	3/8	1/2
Outdoor Unit Side Suction Gas Pipe	inch	5/8	5/8	7/8
Outdoor Unit Side Discharge Gas Pipe	inch	1/2	1/2	3/4
Outdoor Unit Side Liquid Pipe	inch	3/8	3/8	1/2
Max. Connectable Indoor Units		6	10	16
Max. Total Pipe Length	m	50	50	50
Max. Height Difference Between Indoor Units	m	±3.0	±3.0	±3.0

\*All [Accessories](#) / [Controls](#)

Related items - Y1124FE:

- [Full specification](#)
- [BIM files](#)
- [CAD files](#)
- [Dimensional drawing](#)
- [Wiring diagram](#)
- [Installation manual](#)



Related items - Y1804FE:

- [Full specification](#)
- [BIM files](#)
- [CAD files](#)
- [Dimensional drawing](#)
- [Wiring diagram](#)
- [Installation manual](#)



Related items - Y2804FE:

- [Full specification](#)
- [BIM files](#)
- [CAD files](#)
- [Dimensional drawing](#)
- [Wiring diagram](#)
- [Installation manual](#)



## VRF SHRMe R410a: Multi flow selector boxes:

Flow Selector Boxes: The Toshiba FS Box is the smallest and lightest heat recovery box on the market, offering exceptional performance and easy maintenance in a compact and quiet design.



Hi - Res Image 

Multi Flow Selector Unit	RBM-	Y1801F4PE	Y1801F6PE
Height x Width x Depth	mm	215 x 1157 x 687	215 x 1477 x 687
Weight	kg	38	53
Number of Ports		4	6
Max. Connectable Indoor Units per Port		10	10
Max. Connectable Indoor Units		40	60
Max. Remote Controller per Port Individual Indoor Unit Control		10	10
Max. Remote Controller per Port Group Indoor Unit Control		2	2
Max. Pipe Length from Single Port	m	50	50
Max. Total Pipe Length from All Ports	m	120	180
Max. Height Difference Between Indoor Units	m	±3.0	±3.0
Power Supply	V-ph-Hz	220-240/1/50	220-240/1/50
Suggested Fused Supply	A	5	5

### Multi Unit Indoor Side Connection For Flow Selector

MM*-AP***		005 to 012	015 to 018	024 to 056
Indoor Unit Side Gas Pipe Real Length ≤ 15 m	inch	3/8	1/2	5/8
Indoor Unit Side Liquid Pipe Real Length ≤ 15 m	inch	1/4	1/4	3/8
Indoor Unit Side Gas Pipe Real Length >15 m	inch	1/2	5/8	5/8
Indoor Unit Side Liquid Pipe Real Length >15 m	inch	3/8	3/8	3/8
Max. Pipe Length to Indoor Unit	m	50	50	50

### Multi Unit Outdoor Side Connection For Flow Selector

Indoor unit capacity code		Less than 6.4 hp	6.4 hp or more Less than 12.2 hp	12.2 hp or more Less than 16.2 hp	16.2 hp or more Less than 20.2 hp
Outdoor Unit Side Suction Gas Pipe	inch	5/8	7/8	1-1/8	1-1/8
Outdoor Unit Side Discharge Gas Pipe	inch	1/2	3/4	7/8	7/8
Outdoor Unit Side Liquid Pipe	inch	3/8	1/2	5/8	3/4
Max. Connectable Indoor Units		10	20	27	33

### Multi Unit Outdoor Side Connection For Flow Selector (continued)

Indoor unit capacity code		20.2 hp or more Less than 25.2 hp	25.2 hp or more Less than 35.2 hp	More than 35.2 hp
Outdoor Unit Side Suction Gas Pipe	inch	1-3/8	1-3/8	1-5/8
Outdoor Unit Side Discharge Gas Pipe	inch	1-1/8	1-1/8	1-3/8
Outdoor Unit Side Liquid Pipe	inch	3/4	7/8	7/8
Max. Connectable Indoor Units		42	58	60

\*All [Accessories](#) / [Controls](#)

#### Related items - Y1801F4PE:

- [Full specification](#)
- [BIM files](#)
- [Dimensional drawing](#)
- [Wiring diagram](#)
- [Installation manual](#)

#### Related items - Y1801F6PE:

- [Full specification](#)
- [BIM files](#)
- [Dimensional drawing](#)
- [Wiring diagram](#)
- [Installation manual](#)





# MINI SMMS



## VRF MINI SMMS R32: MCY - MUG0401HSW-E

### STAND ALONE - SINGLE FAN

- SEER up to: 9.98 SCOP up to: 5.21.
- Extended refrigerant piping capability (300m).
- Optimized outdoor system sound level: Low as 44dB(A).
- Mini-SMMS encompasses into a compact 0.37m<sup>2</sup> footprint.
- R32 low GWP refrigerant to reduce the total equivalent CO2 by 80%.



Hi - Res Image

### Performance & Outdoor Data

Capacity Range		HP	4
Maximum Number of Indoor Units		QTY	8
Cooling Capacity		kW	12.1
Heating Capacity		kW	14.2
Operating Range	Cooling	°C	-5.0 to 46.0
	Heating		-20.0 to 15.5
Cooling	Power Consumption	kW	2.92
	EER/SEER/Energy Efficiency Class (or nsc %)		4.14/9.98/396.2
Heating	Power Consumption	kW	2.38
	COP/SCOP/Energy Efficiency Class (or nsc (A) %)		5.08/5.21/205.4
Fan(s)	Standard Air Flow	l/s	1266
	Standard Air Flow	m <sup>3</sup> /h	4560
Sound	Pressure Level C/H	dB(A)	52/54
	Power Level C/H	dB(A)	69/71
Unit(s)	Height x Width x Depth	mm	1050 x 1010 x 370
	Weight	kg	100
Pipe Connections	Refrigerant Base Charge	kg	2.4
	Suction Gas Pipe Flare	inch	5/8
Maximum	Liquid Pipe Flare	inch	3/8
	Equivalent Length	m	150
	Real Length	m	120
	Total Pipe Length (Liquid Line Real Length)	m	300
	Length To First Branch	m	40
	Real Length of Indoor Unit Connecting Piping	m	15
	Height Difference Outdoor Higher Than Indoor Units	m	50
	Height Difference Outdoor Lower Than Indoor Units	m	40
	Height Difference Between Indoor Units	m	15
	Electrical	Electrical Characteristic Running Current Cooling/Heating	A
Power Supply Wiring Starting Current		A	Soft Start
Power Supply		V-ph-Hz	220/240-1-50
Suggested Fused Supply(s)		A	20

\*All [Accessories](#) / [Controls](#)

### Related items:

- [Full specification](#)
- [BIM files](#)
- [CAD files](#)
- [Refrigerant cycle](#)
- [Dimensional drawing](#)
- [Wiring diagram](#)
- [Noise curve data](#)
- [Installation manual](#)

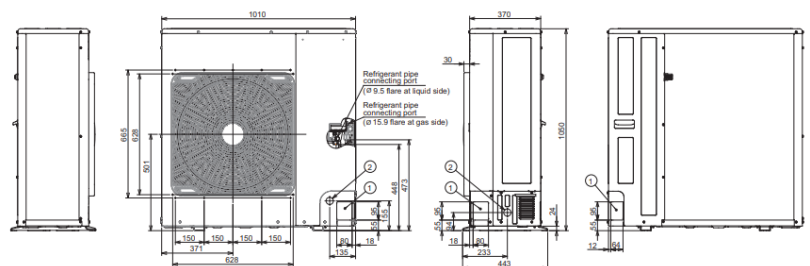

## VRF MINI SMMS R32: MCY - MUG0501HSW-E

### STAND ALONE - SINGLE FAN

- SEER up to: 9.21 SCOP up to: 4.93.
- Extended refrigerant piping capability (300m).
- Optimized outdoor system sound level: Low as 44dB(A).
- MINI-SMMS encompasses into a compact 0.37m<sup>2</sup> footprint.
- R32 low GWP refrigerant to reduce the total equivalent CO2 by 80%.



Hi - Res Image 

### Performance & Outdoor Data

Capacity Range		HP	5
Maximum Number of Indoor Units		QTY	10
Cooling Capacity		kW	14.0
Heating Capacity		kW	16.0
Operating Range	Cooling	°C	-5.0 to 46.0
	Heating		-20.0 to 15.5
Cooling	Power Consumption	kW	3.73
	EER/SEER/Energy Efficiency Class (or nsc %)		3.75/9.21/365.4
Heating	Power Consumption	kW	2.95
	COP/SCOP/Energy Efficiency Class (or nsc (A) %)		4.75/4.93/194.2
Fan(s)	Standard Air Flow	l/s	1316
	Standard Air Flow	m <sup>3</sup> /h	4740
Sound	Pressure Level C/H	dB(A)	53/55
	Power Level C/H	dB(A)	70/72
Unit(s)	Height x Width x Depth	mm	1050 x 1010 x 370
	Weight	kg	100
Pipe Connections	Refrigerant Base Charge	kg	2.4
	Suction Gas Pipe Flare	inch	5/8
Maximum	Liquid Pipe Flare	inch	3/8
	Equivalent Length	m	150
	Real Length	m	120
	Total Pipe Length (Liquid Line Real Length)	m	300
	Length To First Branch	m	40
	Real Length of Indoor Unit Connecting Piping	m	15
	Height Difference Outdoor Higher Than Indoor Units	m	50
	Height Difference Outdoor Lower Than Indoor Units	m	40
	Height Difference Between Indoor Units	m	15
	Electrical	Electrical Characteristic Running Current Cooling/Heating	A
Power Supply Wiring Starting Current		A	Soft Start
Power Supply		V-ph-Hz	220/240-1-50
Suggested Fused Supply(s)		A	25

\*All [Accessories](#) / [Controls](#)

### Related items:

- [Full specification](#)
- [BIM files](#)
- [CAD files](#)
- [Refrigerant cycle](#)
- [Dimensional drawing](#)
- [Wiring diagram](#)
- [Noise curve data](#)
- [Installation manual](#)

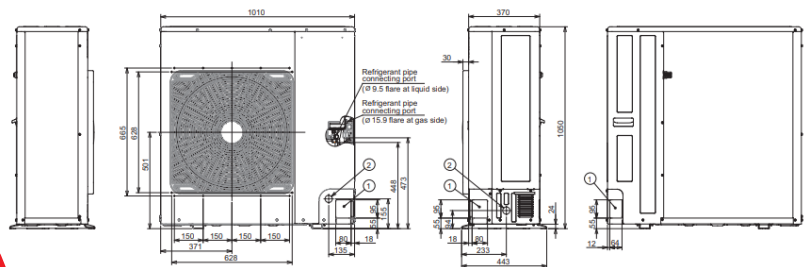

## VRF MINI SMMS R32: MCY - MUG0601HSW-E

### STAND ALONE - SINGLE FAN

- SEER up to: 8.80 SCOP up to: 4.80.
- Extended refrigerant piping capability (300m).
- Optimized outdoor system sound level: Low as 44dB(A).
- Mini-SMMS encompasses into a compact 0.37m<sup>2</sup> footprint.
- R32 low GWP refrigerant to reduce the total equivalent CO2 by 80%.



Hi - Res Image 

### Performance & Outdoor Data

Capacity Range		HP	6
Maximum Number of Indoor Units		QTY	13
Cooling Capacity		kW	15.5
Heating Capacity		kW	17.0
Operating Range	Cooling	°C	-5.0 to 46.0
	Heating		-20.0 to 15.5
Cooling	Power Consumption	kW	4.29
	EER/SEER/Energy Efficiency Class (or nsc %)		3.61/8.80/349.0
Heating	Power Consumption	kW	3.36
	COP/SCOP/Energy Efficiency Class (or nsc (A) %)		4.61/4.80/189.0
Fan(s)	Standard Air Flow	l/s	1316
	Standard Air Flow	m <sup>3</sup> /h	4740
Sound	Pressure Level C/H	dB(A)	54/56
	Power Level C/H	dB(A)	71/73
Unit(s)	Height x Width x Depth	mm	1050 x 1010 x 370
	Weight	kg	100
Pipe Connections	Refrigerant Base Charge	kg	2.4
	Suction Gas Pipe Flare	inch	5/8
	Liquid Pipe Flare	inch	3/8
Maximum	Equivalent Length	m	150
	Real Length	m	120
	Total Pipe Length (Liquid Line Real Length)	m	300
	Length To First Branch	m	40
	Real Length of Indoor Unit Connecting Piping	m	15
	Height Difference Outdoor Higher Than Indoor Units	m	50
	Height Difference Outdoor Lower Than Indoor Units	m	40
	Height Difference Between Indoor Units	m	15
Electrical	Electrical Characteristic Running Current Cooling/Heating	A	20.3/16.1
	Power Supply Wiring Starting Current	A	Soft Start
	Power Supply	V-ph-Hz	220/240-1-50
	Suggested Fused Supply(s)	A	32

\*All [Accessories / Controls](#)

### Related items:

- [Full specification](#)
- [BIM files](#)
- [CAD files](#)
- [Refrigerant cycle](#)
- [Dimensional drawing](#)
- [Wiring diagram](#)
- [Noise curve data](#)
- [Installation manual](#)

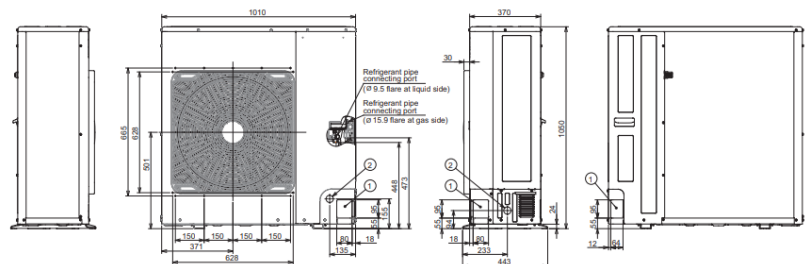





# SHRM ADVANCE

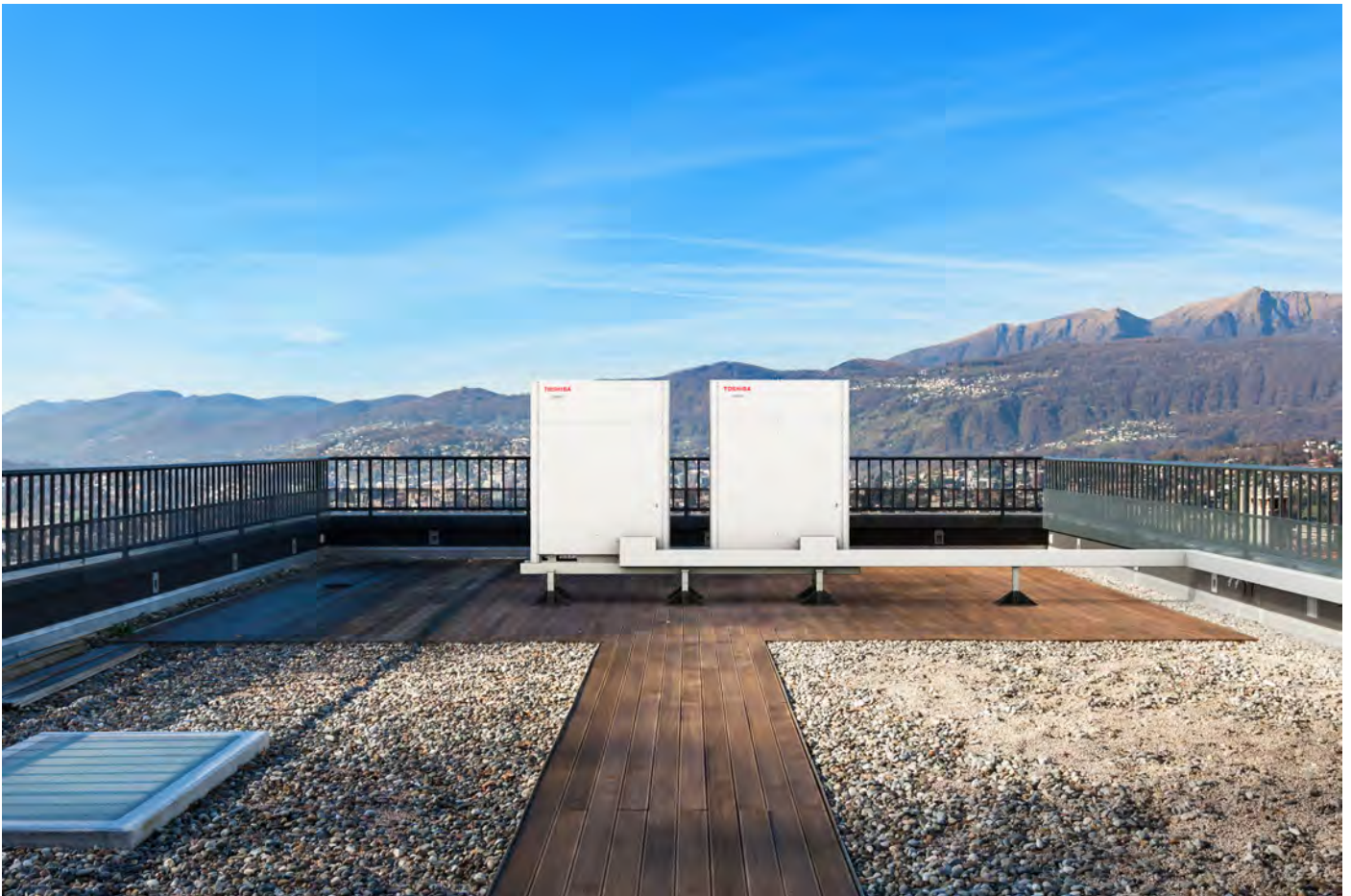

## VRF SHRMα R32: MMY - SUG0801MT8P-E

### STAND ALONE

- Market leading efficiency : SEER 8.9 - SCOP 4.44.
- Low footprint chassis that gives ultimate installation flexibility.
- One product two possibilities: - 2-pipe heat pump / 3-pipe heat recovery.
- Up to 24HP in a single module, never experienced before with R32 refrigerant.
- R32's GWP, combined with SHRMα 40% reduced refrigerant charge, gives up to 83% CO<sub>2</sub> reduction.



Hi - Res Image

### Performance & Outdoor Data

Capacity Range		HP	8	
Maximum Number of Indoor Units		QTY	18	
Cooling Capacity		kW	22.4	
Heating Capacity		kW	25.0	
Operating Range	Cooling	°C	-15.0 to 50.0	
	Heating		-25.0 to 15.5	
Cooling	Power Consumption	kW	5.13	
	EER/SEER/Energy Efficiency Class (or nsc %)		4.37/8.90/353.0	
Heating	Power Consumption	kW	4.96	
	COP/SCOP/Energy Efficiency Class (or nsc(A) %)		4.52/4.44/174.6	
Fan(s)	Standard Air Flow H	l/s	2750	
	Standard Air Flow H	m <sup>3</sup> /h	9900	
	External Static Pressure	Pa	80	
Sound	Pressure Level C/H	dB(A)	53/56	
	Power Level C/H	dB(A)	74/77	
Unit(s)	Height x Width x Depth	mm	1690 x 990 x 780	
	Weight	kg	232	
Pipe Connections	Refrigerant Base Charge	kg	6.0	
	Suction Gas Pipe Brazing	inch	3/4	
	Discharge Pipe Brazing	inch	5/8	
	Liquid Pipe Flare	inch	1/2	
	Equivalent Length	m	215	
	Real Length	m	190	
	Total Pipe Length (Liquid Line Real Length)	m	500	
	Length To First Branch Height Difference Between Indoor Units ≤ 3 m	m	90	
	Length To First Branch Height Difference Between Indoor Units > 3 m	m	65	
	Real Length Between Single Port FS Unit and Indoor Unit	m	50	
Maximum	Real Length Of Indoor Unit Connecting Piping	m	50	
	Equivalent Length Between Branches	m	50	
	Height Difference Outdoor Higher Than Indoor Units	m	90	
	Height Difference Outdoor Lower Than Indoor Units	m	40	
	Height Difference Between Indoor Units	m	40	
	Electrical	Voltage Range Minimum/Maximum	V	342/456
		Electrical Characteristic Running Current Cooling/Heating	A	9.14/8.95
Power Supply Wiring Starting Current		A	Soft Start	
Power Supply		V/ph/Hz	380-415/3/50	
Suggested Fused Supply(s)		A	20	

\*All [Accessories](#) / [Controls](#)

Related items:

- [Full specification](#)
- [BIM files](#)
- [CAD files](#)
- [Refrigerant cycle](#)
- [Dimensional drawing](#)
- [Wiring diagram](#)
- [Noise curve data](#)
- [Installation manual](#)

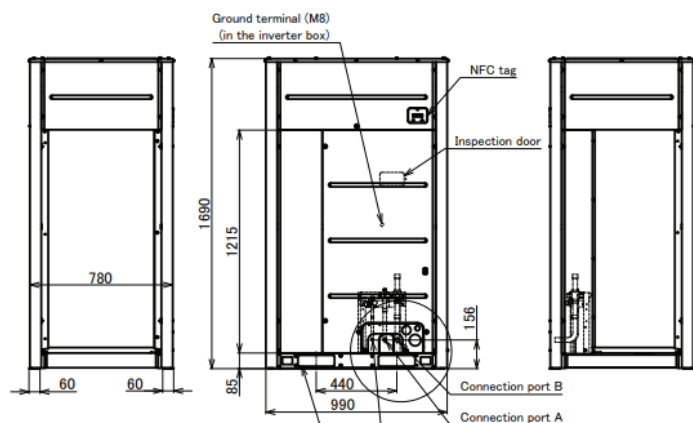

## VRF SHRMa R32: MMY - SUG1001MT8P-E

### STAND ALONE

- Market leading efficiency : SEER 8.69 - SCOP 4.67.
- Low footprint chassis that gives ultimate installation flexibility.
- One product two possibilities: - 2-pipe heat pump / 3-pipe heat recovery.
- Up to 24HP in a single module, never experienced before with R32 refrigerant.
- R32's GWP, combined with SHRMa 40% reduced refrigerant charge, gives up to 83% CO<sub>2</sub> reduction.



Hi - Res Image 

### Performance & Outdoor Data

Capacity Range		HP	10
Maximum Number of Indoor Units		QTY	22
Cooling Capacity		kW	28.0
Heating Capacity		kW	31.5
Operating Range	Cooling	°C	-15.0 to 50.0
	Heating		-25.0 to 15.5
Cooling	Power Consumption	kW	6.83
	EER/SEER/Energy Efficiency Class (or nsc %)		4.10/8.69/344.6
Heating	Power Consumption	kW	6.22
	COP/SCOP/Energy Efficiency Class (or nsc(A) %)		4.50/4.67/183.8
Fan(s)	Standard Air Flow H	l/s	2916
	Standard Air Flow H	m <sup>3</sup> /h	10500
	External Static Pressure	Pa	80
Sound	Pressure Level C/H	dB(A)	55/58
	Power Level C/H	dB(A)	75/78
Unit(s)	Height x Width x Depth	mm	1690 x 990 x 780
	Weight	kg	232
	Refrigerant Base Charge	kg	6.0
Pipe Connections	Suction Gas Pipe Brazing	inch	7/8
	Discharge Pipe Brazing	inch	3/4
	Liquid Pipe Flare	inch	1/2
	Equivalent Length	m	215
	Real Length	m	190
	Total Pipe Length (Liquid Line Real Length)	m	500
	Length To First Branch Height Difference Between Indoor Units ≤ 3 m	m	90
Maximum	Length To First Branch Height Difference Between Indoor Units > 3 m	m	65
	Real Length Between Single Port FS Unit and Indoor Unit	m	50
	Real Length Of Indoor Unit Connecting Piping	m	50
	Equivalent Length Between Branches	m	50
	Height Difference Outdoor Higher Than Indoor Units	m	90
	Height Difference Outdoor Lower Than Indoor Units	m	40
	Height Difference Between Indoor Units	m	40
Electrical	Voltage Range Minimum/Maximum	V	342/456
	Electrical Characteristic Running Current Cooling/Heating	A	11.50/10.60
	Power Supply Wiring Starting Current	A	Soft Start
	Power Supply	V/ph/Hz	380-415/3/50
	Suggested Fused Supply(s)	A	20

### \*All [Accessories](#) / [Controls](#)

#### Related items:

- [Full specification](#)
- [BIM files](#)
- [CAD files](#)
- [Refrigerant cycle](#)
- [Dimensional drawing](#)
- [Wiring diagram](#)
- [Noise curve data](#)
- [Installation manual](#)

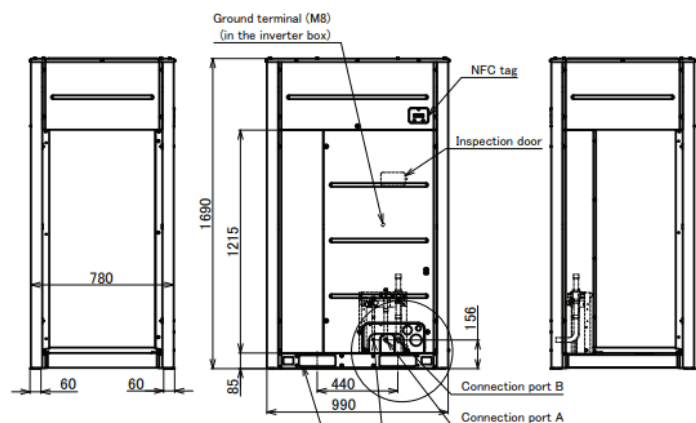

## VRF SHRMa R32: MMY - SUG1201MT8P-E

### STAND ALONE

- Market leading efficiency : SEER 8.23 - SCOP 4.62.
- Low footprint chassis that gives ultimate installation flexibility.
- One product two possibilities: - 2-pipe heat pump / 3-pipe heat recovery.
- Up to 24HP in a single module, never experienced before with R32 refrigerant.
- R32's GWP, combined with SHRMa 40% reduced refrigerant charge, gives up to 83% CO<sub>2</sub> reduction.



Hi - Res Image 

### Performance & Outdoor Data

Capacity Range		HP	12	
Maximum Number of Indoor Units		QTY	27	
Cooling Capacity		kW	33.5	
Heating Capacity		kW	37.5	
Operating Range	Cooling	°C	-15.0 to 50.0	
	Heating		-25.0 to 15.5	
Cooling	Power Consumption	kW	8.88	
	EER/SEER/Energy Efficiency Class (or nsc %)		3.77/8.23/326.2	
Heating	Power Consumption	kW	7.64	
	COP/SCOP/Energy Efficiency Class (or nsc(A) %)		4.38/4.62/181.8	
Fan(s)	Standard Air Flow H	l/s	3250	
	Standard Air Flow H	m <sup>3</sup> /h	11700	
	External Static Pressure	Pa	80	
Sound	Pressure Level C/H	dB(A)	58/62	
	Power Level C/H	dB(A)	79/82	
Unit(s)	Height x Width x Depth	mm	1690 x 990 x 780	
	Weight	kg	232	
Pipe Connections	Refrigerant Base Charge	kg	6.0	
	Suction Gas Pipe Brazing	inch	1-1/8	
	Discharge Pipe Brazing	inch	3/4	
	Liquid Pipe Flare	inch	1/2	
	Equivalent Length	m	215	
	Real Length	m	190	
	Total Pipe Length (Liquid Line Real Length)	m	500	
	Length To First Branch Height Difference Between Indoor Units ≤ 3 m	m	90	
	Length To First Branch Height Difference Between Indoor Units > 3 m	m	65	
	Real Length Between Single Port FS Unit and Indoor Unit	m	50	
Maximum	Real Length Of Indoor Unit Connecting Piping	m	50	
	Equivalent Length Between Branches	m	50	
	Height Difference Outdoor Higher Than Indoor Units	m	90	
	Height Difference Outdoor Lower Than Indoor Units	m	40	
	Height Difference Between Indoor Units	m	40	
	Electrical	Voltage Range Minimum/Maximum	V	342/456
		Electrical Characteristic Running Current Cooling/Heating	A	14.20/12.5
Power Supply Wiring Starting Current		A	Soft Start	
Power Supply		V/ph/Hz	380-415/3/50	
Suggested Fused Supply(s)		A	20	

\*All [Accessories](#) / [Controls](#)

Related items:

- [Full specification](#)
- [BIM files](#)
- [CAD files](#)
- [Refrigerant cycle](#)
- [Dimensional drawing](#)
- [Wiring diagram](#)
- [Noise curve data](#)
- [Installation manual](#)

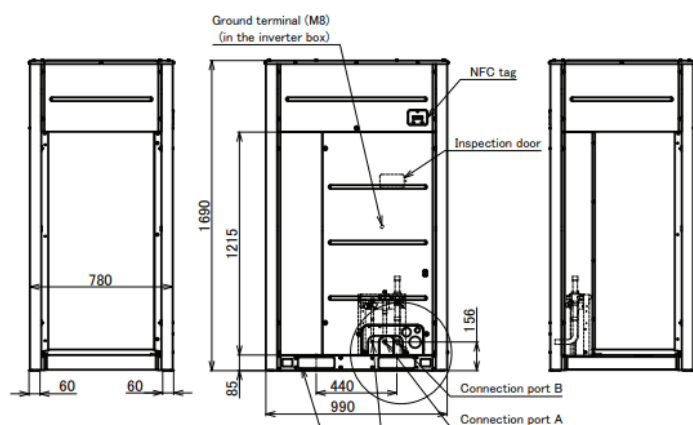

## VRF SHRMa R32: MMY - SUG1401MT8P-E

### STAND ALONE

- Market leading efficiency : SEER 8.08 - SCOP 4.30.
- Low footprint chassis that gives ultimate installation flexibility.
- One product two possibilities: - 2-pipe heat pump / 3-pipe heat recovery.
- Up to 24HP in a single module, never experienced before with R32 refrigerant.
- R32's GWP, combined with SHRMa 40% reduced refrigerant charge, gives up to 83% CO<sub>2</sub> reduction.



Hi - Res Image 

Performance & Outdoor Data				
Capacity Range		HP	14	
Maximum Number of Indoor Units		QTY	31	
Cooling Capacity		kW	40.0	
Heating Capacity		kW	45.0	
Operating Range	Cooling	°C	-15.0 to 50.0	
	Heating		-25.0 to 15.5	
Cooling	Power Consumption	kW	12.04	
	EER/SEER/Energy Efficiency Class (or nsc %)		3.32/8.08/320.2	
Heating	Power Consumption	kW	10.28	
	COP/SCOP/Energy Efficiency Class (or nsc(A) %)		3.89/4.30/169.0	
Fan(s)	Standard Air Flow H	l/s	3300	
	Standard Air Flow H	m <sup>3</sup> /h	11880	
	External Static Pressure	Pa	80	
Sound	Pressure Level C/H	dB(A)	58/63	
	Power Level C/H	dB(A)	79/84	
Unit(s)	Height x Width x Depth	mm	1690 x 990 x 780	
	Weight	kg	232	
	Refrigerant Base Charge	kg	6.0	
Pipe Connections	Suction Gas Pipe Brazing	inch	1-1/8	
	Discharge Pipe Brazing	inch	7/8	
	Liquid Pipe Flare	inch	5/8	
	Equivalent Length	m	215	
	Real Length	m	190	
	Total Pipe Length (Liquid Line Real Length)	m	500	
	Length To First Branch Height Difference Between Indoor Units ≤ 3 m	m	90	
	Length To First Branch Height Difference Between Indoor Units > 3 m	m	65	
	Real Length Between Single Port FS Unit and Indoor Unit	m	50	
	Real Length Of Indoor Unit Connecting Piping	m	50	
Maximum	Equivalent Length Between Branches	m	50	
	Height Difference Outdoor Higher Than Indoor Units	m	90	
	Height Difference Outdoor Lower Than Indoor Units	m	40	
	Height Difference Between Indoor Units	m	40	
	Electrical	Voltage Range Minimum/Maximum	V	342/456
		Electrical Characteristic Running Current Cooling/Heating	A	18.90/16.30
Power Supply Wiring Starting Current		A	Soft Start	
Power Supply		V/ph/Hz	380-415/3/50	
Suggested Fused Supply(s)		A	25	

### \*All [Accessories](#) / [Controls](#)

#### Related items:

- [Full specification](#)
- [BIM files](#)
- [CAD files](#)
- [Refrigerant cycle](#)
- [Dimensional drawing](#)
- [Wiring diagram](#)
- [Noise curve data](#)
- [Installation manual](#)

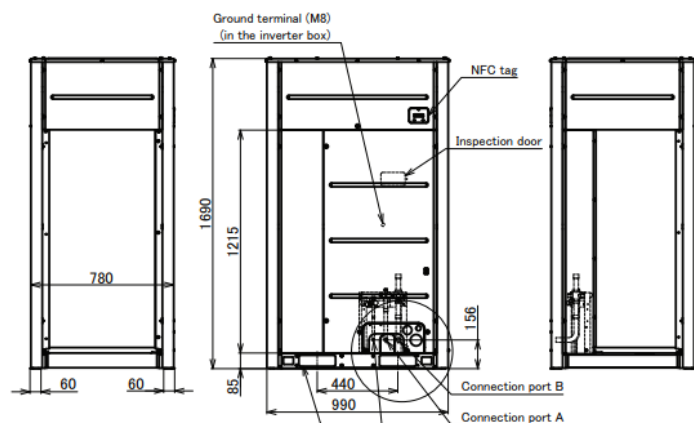

## VRF SHRMa R32: MMY - SUG1601MT8P-E

### STAND ALONE

- Market leading efficiency : SEER 8.64 - SCOP 4.65.
- Low footprint chassis that gives ultimate installation flexibility.
- One product two possibilities: - 2-pipe heat pump / 3-pipe heat recovery.
- Up to 24HP in a single module, never experienced before with R32 refrigerant.
- R32's GWP, combined with SHRMa 40% reduced refrigerant charge, gives up to 83% CO<sub>2</sub> reduction.



Hi - Res Image

### Performance & Outdoor Data

Capacity Range		HP	16
Maximum Number of Indoor Units		QTY	36
Cooling Capacity		kW	45.0
Heating Capacity		kW	50.0
Operating Range	Cooling	°C	-15.0 to 50.0
	Heating		-25.0 to 15.5
Cooling	Power Consumption	kW	12.16
	EER/SEER/Energy Efficiency Class (or nsc %)		3.70/8.64/342.6
Heating	Power Consumption	kW	11.06
	COP/SCOP/Energy Efficiency Class (or nsc(A) %)		4.07/4.65/183
Fan(s)	Standard Air Flow H	l/s	4250
	Standard Air Flow H	m <sup>3</sup> /h	15300
	External Static Pressure	Pa	80
Sound	Pressure Level C/H	dB(A)	60/64
	Power Level C/H	dB(A)	83/87
Unit(s)	Height x Width x Depth	mm	1690 x 1290 x 780
	Weight	kg	329
	Refrigerant Base Charge	kg	9
Pipe Connections	Suction Gas Pipe Brazing	inch	1-1/8
	Discharge Pipe Brazing	inch	7/8
	Liquid Pipe Flare	inch	5/8
Maximum	Equivalent Length	m	215
	Real Length	m	190
	Total Pipe Length (Liquid Line Real Length)	m	500
	Length To First Branch Height Difference Between Indoor Units ≤ 3 m	m	90
	Length To First Branch Height Difference Between Indoor Units > 3 m	m	65
	Real Length Between Single Port FS Unit and Indoor Unit	m	50
	Real Length Of Indoor Unit Connecting Piping	m	50
	Equivalent Length Between Branches	m	50
	Height Difference Outdoor Higher Than Indoor Units	m	90
	Height Difference Outdoor Lower Than Indoor Units	m	40
Electrical	Height Difference Between Indoor Units	m	40
	Voltage Range Minimum/Maximum	V	342/456
	Electrical Characteristic Running Current Cooling/Heating	A	21.10/19.90
	Power Supply Wiring Starting Current	A	Soft Start
	Power Supply	V/ph/Hz	380-415/3/50
Suggested Fused Supply(s)	A	32	

\*All [Accessories](#) / [Controls](#)

Related items:

- [Full specification](#)
- [BIM files](#)
- [CAD files](#)
- [Refrigerant cycle](#)
- [Dimensional drawing](#)
- [Wiring diagram](#)
- [Noise curve data](#)
- [Installation manual](#)

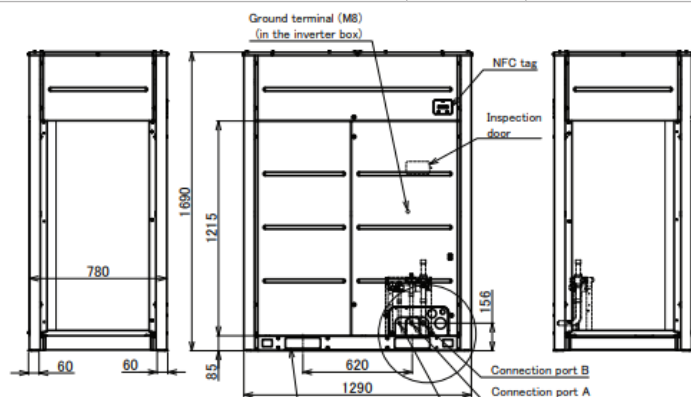

## VRF SHRMa R32: MMY - SUG1801MT8P-E

### STAND ALONE

- Market leading efficiency : SEER 8.32 - SCOP 4.49.
- Low footprint chassis that gives ultimate installation flexibility.
- One product two possibilities: - 2-pipe heat pump / 3-pipe heat recovery.
- Up to 24HP in a single module, never experienced before with R32 refrigerant.
- R32's GWP, combined with SHRMa 40% reduced refrigerant charge, gives up to 83% CO<sub>2</sub> reduction.



Hi - Res Image

### Performance & Outdoor Data

Capacity Range		HP	18
Maximum Number of Indoor Units		QTY	40
Cooling Capacity		kW	50.4
Heating Capacity		kW	56.0
Operating Range	Cooling	°C	-15.0 to 50.0
	Heating		-25.0 to 15.5
Cooling	Power Consumption	kW	14.78
	EER/SEER/Energy Efficiency Class (or nsc %)		3.41/8.32/329.8
Heating	Power Consumption	kW	14.00
	COP/SCOP/Energy Efficiency Class (or nsc(A) %)		3.60/4.49/176.6
Fan(s)	Standard Air Flow H	l/s	4666
	Standard Air Flow H	m <sup>3</sup> /h	16800
	External Static Pressure	Pa	80
Sound	Pressure Level C/H	dB(A)	61/67
	Power Level C/H	dB(A)	84/89
Unit(s)	Height x Width x Depth	mm	1690 x 1290 x 780
	Weight	kg	329
	Refrigerant Base Charge	kg	9
Pipe Connections	Suction Gas Pipe Brazing	inch	1-1/8
	Discharge Pipe Brazing	inch	7/8
	Liquid Pipe Flare	inch	5/8
Maximum	Equivalent Length	m	215
	Real Length	m	190
	Total Pipe Length (Liquid Line Real Length)	m	500
	Length To First Branch Height Difference Between Indoor Units ≤ 3 m	m	90
	Length To First Branch Height Difference Between Indoor Units > 3 m	m	65
	Real Length Between Single Port FS Unit and Indoor Unit	m	50
	Real Length Of Indoor Unit Connecting Piping	m	50
	Equivalent Length Between Branches	m	50
	Height Difference Outdoor Higher Than Indoor Units	m	90
	Height Difference Outdoor Lower Than Indoor Units	m	40
Electrical	Height Difference Between Indoor Units	m	40
	Voltage Range Minimum/Maximum	V	342/456
	Electrical Characteristic Running Current Cooling/Heating	A	24.80/23.80
	Power Supply Wiring Starting Current	A	Soft Start
	Power Supply	V/ph/Hz	380-415/3/50
	Suggested Fused Supply(s)	A	32

\*All [Accessories](#) / [Controls](#)

Related items:

- [Full specification](#)
- [BIM files](#)
- [CAD files](#)
- [Refrigerant cycle](#)
- [Dimensional drawing](#)
- [Wiring diagram](#)
- [Noise curve data](#)
- [Installation manual](#)

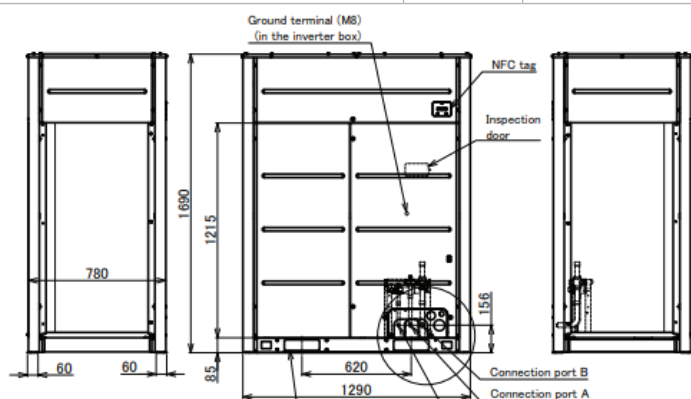

## VRF SHRMa R32: MMY - SUG2001MT8P-E

### STAND ALONE

- Market leading efficiency : SEER 8.29 - SCOP 4.29.
- Low footprint chassis that gives ultimate installation flexibility.
- One product two possibilities: - 2-pipe heat pump / 3-pipe heat recovery.
- Up to 24HP in a single module, never experienced before with R32 refrigerant.
- R32's GWP, combined with SHRMa 40% reduced refrigerant charge, gives up to 83% CO<sub>2</sub> reduction.



Hi - Res Image

### Performance & Outdoor Data

Capacity Range		HP	20
Maximum Number of Indoor Units		QTY	45
Cooling Capacity		kW	56.0
Heating Capacity		kW	63.0
Operating Range	Cooling	°C	-15.0 to 50.0
	Heating		-25.0 to 15.5
Cooling	Power Consumption	kW	15.47
	EER/SEER/Energy Efficiency Class (or nsc %)		3.62/8.29/328.6
Heating	Power Consumption	kW	14.25
	COP/SCOP/Energy Efficiency Class (or nsc(A) %)		3.93/4.29/168.6
Fan(s)	Standard Air Flow H	l/s	4416
	Standard Air Flow H	m <sup>3</sup> /h	15900
	External Static Pressure	Pa	80
Sound	Pressure Level C/H	dB(A)	63/67
	Power Level C/H	dB(A)	85/89
Unit(s)	Height x Width x Depth	mm	1690 x 1290 x 780
	Weight	kg	361
	Refrigerant Base Charge	kg	9
Pipe Connections	Suction Gas Pipe Brazing	inch	1-1/8
	Discharge Pipe Brazing	inch	7/8
	Liquid Pipe Flare	inch	5/8
Maximum	Equivalent Length	m	215
	Real Length	m	190
	Total Pipe Length (Liquid Line Real Length)	m	500
	Length To First Branch Height Difference Between Indoor Units ≤ 3 m	m	90
	Length To First Branch Height Difference Between Indoor Units > 3 m	m	65
	Real Length Between Single Port FS Unit and Indoor Unit	m	50
	Real Length Of Indoor Unit Connecting Piping	m	50
	Equivalent Length Between Branches	m	50
	Height Difference Outdoor Higher Than Indoor Units	m	90
	Height Difference Outdoor Lower Than Indoor Units	m	40
Electrical	Height Difference Between Indoor Units	m	40
	Voltage Range Minimum/Maximum	V	342/456
	Electrical Characteristic Running Current Cooling/Heating	A	25.40/23.60
	Power Supply Wiring Starting Current	A	Soft Start
	Power Supply	V/ph/Hz	380-415/3/50
	Suggested Fused Supply(s)	A	32

\*All [Accessories](#) / [Controls](#)

Related items:

- [Full specification](#)
- [BIM files](#)
- [CAD files](#)
- [Refrigerant cycle](#)
- [Dimensional drawing](#)
- [Wiring diagram](#)
- [Noise curve data](#)
- [Installation manual](#)

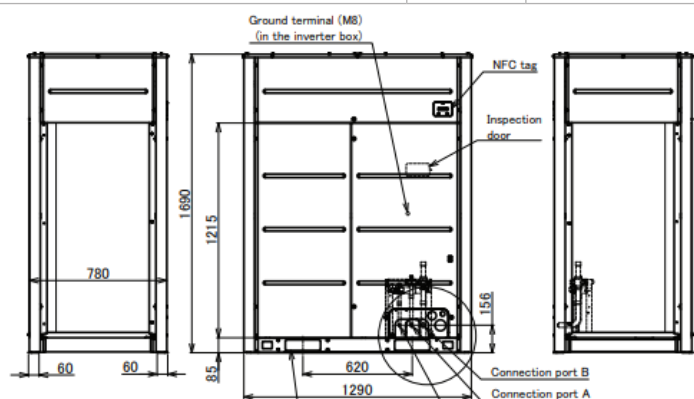



## VRF SHRMa R32: MMY - SUG2201MT8P-E

### STAND ALONE

- Market leading efficiency : SEER 7.88 - SCOP 4.26.
- Low footprint chassis that gives ultimate installation flexibility.
- One product two possibilities: - 2-pipe heat pump / 3-pipe heat recovery.
- Up to 24HP in a single module, never experienced before with R32 refrigerant.
- R32's GWP, combined with SHRMa 40% reduced refrigerant charge, gives up to 83% CO<sub>2</sub> reduction.



Hi - Res Image

### Performance & Outdoor Data

Capacity Range		HP	22	
Maximum Number of Indoor Units		QTY	49	
Cooling Capacity		kW	61.5	
Heating Capacity		kW	69.0	
Operating Range	Cooling	°C	-15.0 to 50.0	
	Heating		-25.0 to 15.5	
Cooling	Power Consumption	kW	18.19	
	EER/SEER/Energy Efficiency Class (or nsc %)		3.38/7.88/312.2	
Heating	Power Consumption	kW	16.10	
	COP/SCOP/Energy Efficiency Class (or nsc(A) %)		3.82/4.26/167.4	
Fan(s)	Standard Air Flow H	l/s	4583	
	Standard Air Flow H	m <sup>3</sup> /h	16500	
	External Static Pressure	Pa	80	
Sound	Pressure Level C/H	dB(A)	64/67	
	Power Level C/H	dB(A)	86/90	
Unit(s)	Height x Width x Depth	mm	1690 x 1290 x 780	
	Weight	kg	361	
	Refrigerant Base Charge	kg	9	
Pipe Connections	Suction Gas Pipe Brazing	inch	1-1/8	
	Discharge Pipe Brazing	inch	7/8	
	Liquid Pipe Flare	inch	5/8	
	Equivalent Length	m	215	
	Real Length	m	190	
	Total Pipe Length (Liquid Line Real Length)	m	500	
	Length To First Branch Height Difference Between Indoor Units ≤ 3 m	m	90	
	Length To First Branch Height Difference Between Indoor Units > 3 m	m	65	
	Real Length Between Single Port FS Unit and Indoor Unit	m	50	
	Real Length Of Indoor Unit Connecting Piping	m	50	
Maximum	Equivalent Length Between Branches	m	50	
	Height Difference Outdoor Higher Than Indoor Units	m	90	
	Height Difference Outdoor Lower Than Indoor Units	m	40	
	Height Difference Between Indoor Units	m	40	
	Electrical	Voltage Range Minimum/Maximum	V	342/456
		Electrical Characteristic Running Current Cooling/Heating	A	29.20/26.10
Power Supply Wiring Starting Current		A	Soft Start	
Power Supply		V/ph/Hz	380-415/3/50	
Suggested Fused Supply(s)		A	40	

### \*All [Accessories](#) / [Controls](#)

#### Related items:

- [Full specification](#)
- [BIM files](#)
- [CAD files](#)
- [Refrigerant cycle](#)
- [Dimensional drawing](#)
- [Wiring diagram](#)
- [Noise curve data](#)
- [Installation manual](#)

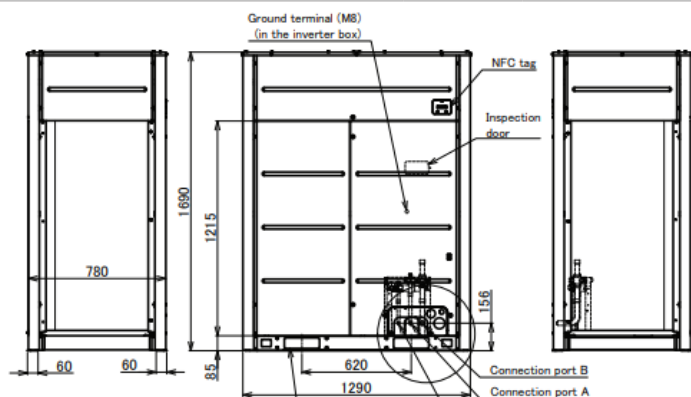

## VRF SHRMa R32: MMY - SUG2401MT8P-E

### STAND ALONE

- Market leading efficiency : SEER 6.66 - SCOP 4.04.
- Low footprint chassis that gives ultimate installation flexibility.
- One product two possibilities: - 2-pipe heat pump / 3-pipe heat recovery.
- Up to 24HP in a single module, never experienced before with R32 refrigerant.
- R32's GWP, combined with SHRMa 40% reduced refrigerant charge, gives up to 83% CO<sub>2</sub> reduction.



Hi - Res Image

### Performance & Outdoor Data

Capacity Range		HP	24	
Maximum Number of Indoor Units		QTY	54	
Cooling Capacity		kW	67.0	
Heating Capacity		kW	70.0	
Operating Range	Cooling	°C	-15.0 to 50.0	
	Heating		-25.0 to 15.5	
Cooling	Power Consumption	kW	24.27	
	EER/SEER/Energy Efficiency Class (or nsc %)		2.76/6.66/263.4	
Heating	Power Consumption	kW	19.48	
	COP/SCOP/Energy Efficiency Class (or nsc(A) %)		3.44/4.04/158.6	
Fan(s)	Standard Air Flow H	l/s	4666	
	Standard Air Flow H	m <sup>3</sup> /h	16800	
	External Static Pressure	Pa	80	
Sound	Pressure Level C/H	dB(A)	64/69	
	Power Level C/H	dB(A)	86/91	
Unit(s)	Height x Width x Depth	mm	1690 x 1290 x 780	
	Weight	kg	361	
	Refrigerant Base Charge	kg	9	
Pipe Connections	Suction Gas Pipe Brazing	inch	1-1/8	
	Discharge Pipe Brazing	inch	7/8	
	Liquid Pipe Flare	inch	5/8	
	Equivalent Length	m	215	
	Real Length	m	190	
	Total Pipe Length (Liquid Line Real Length)	m	500	
	Length To First Branch Height Difference Between Indoor Units ≤ 3 m	m	90	
	Length To First Branch Height Difference Between Indoor Units > 3 m	m	65	
	Real Length Between Single Port FS Unit and Indoor Unit	m	50	
	Real Length Of Indoor Unit Connecting Piping	m	50	
Maximum	Equivalent Length Between Branches	m	50	
	Height Difference Outdoor Higher Than Indoor Units	m	90	
	Height Difference Outdoor Lower Than Indoor Units	m	40	
	Height Difference Between Indoor Units	m	40	
	Electrical	Voltage Range Minimum/Maximum	V	342/456
		Electrical Characteristic Running Current Cooling/Heating	A	38.10/30.90
Power Supply Wiring Starting Current		A	Soft Start	
Power Supply		V/ph/Hz	380-415/3/50	
Suggested Fused Supply(s)		A	50	

\*All [Accessories](#) / [Controls](#)

Related items:

- [Full specification](#)
- [BIM files](#)
- [CAD files](#)
- [Refrigerant cycle](#)
- [Dimensional drawing](#)
- [Wiring diagram](#)
- [Noise curve data](#)
- [Installation manual](#)

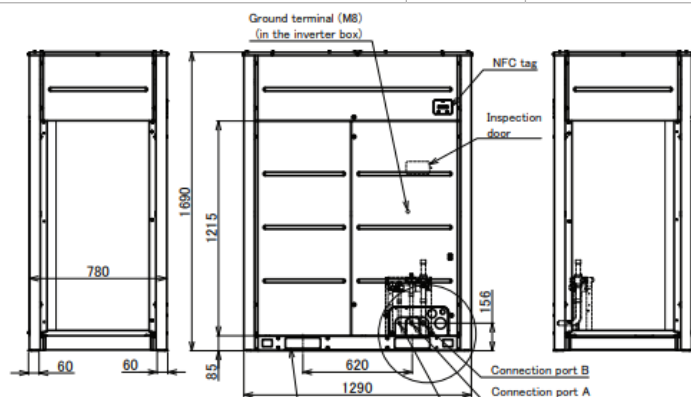

## VRF SHRMa R32: Single flow selector boxes

### STAND ALONE

Toshiba have designed a new range of single & multi flow selector boxes as well as safety shut off valve boxes. They have been designed to increase both the flexibility of the system, but also to enable the system to comply with the requirements of IEC60335-2-40 and EN378. To enable this compliance, both the Flow Selector (F/S) and Shut Off Valve (SV) boxes have been fitted with isolation valves



Hi - Res Image 

Flow Selector Unit	RBM-	Y1121FUPE	Y1801FUPE	Y2801FUPE
Height x Width x Depth	mm	206 x 385 x 282	206 x 385 x 282	206 x 385 x 282
Weight	kg	11	11	11
Standard 5 Core Control Cable Max. Length	m	≤ 300	≤ 300	≤ 300
Standard 3 Core Power Cable Max. Length	m	≤ 50	≤ 50	≤ 50
Power Supply From Indoor Unit	V/ph/Hz	230/240-1-50	230/240-1-50	230/240-1-50
Suggested Fused Supply	A	6	6	6

### Single Unit Connection For Flow Selector

MM*-UP***		003 to 012	015 to 018	024 to 030	036 to 056	072 to 112
Indoor Unit Side Gas Pipe	inch	3/8	1/2	5/8	5/8	7/8
Indoor Unit Side Liquid Pipe	inch	1/4	1/4	3/8	3/8	1/2
Outdoor Unit Side Suction Gas Pipe	inch	5/8	5/8	5/8	5/8	7/8
Outdoor Unit Side Discharge Gas Pipe	inch	1/2	1/2	1/2	1/2	3/4
Outdoor Unit Side Liquid Pipe	inch	3/8	3/8	3/8	3/8	1/2
Max. Pipe Length To Indoor Unit	m	50	50	50	50	50

### Multi Unit Connection For Flow Selector

Indoor unit capacity code		Less than 4 hp	4 hp or more Less than 6.4 hp	6.4 hp or more Less than 10 hp
Indoor Unit Side Gas Pipe	inch	5/8	5/8	7/8
Indoor Unit Side Liquid Pipe	inch	3/8	3/8	1/2
Outdoor Unit Side Suction Gas Pipe	inch	5/8	5/8	7/8
Outdoor Unit Side Discharge Gas Pipe	inch	1/2	1/2	3/4
Outdoor Unit Side Liquid Pipe	inch	3/8	3/8	1/2
Max. Connectable Indoor Units		6	10	16
Max. Total Pipe Length	m	50	50	50
Max. Height Difference Between Indoor Units	m	15	15	15

\*All [Accessories / Controls](#)

Related items - Y1121FUPE:

- [Full specification](#)
- [BIM files](#)
- [CAD files](#)
- [Dimensional drawing](#)
- [Wiring diagram](#)
- [Installation manual](#)



Related items - Y1801FUPE:

- [Full specification](#)
- [BIM files](#)
- [CAD files](#)
- [Dimensional drawing](#)
- [Wiring diagram](#)
- [Installation manual](#)



Related items - Y2801FUPE:

- [Full specification](#)
- [BIM files](#)
- [CAD files](#)
- [Dimensional drawing](#)
- [Wiring diagram](#)
- [Installation manual](#)



## VRF SHRMa R32: Shut-off Valves (2-pipe)

Toshiba have designed a new range of single & multi flow selector boxes as well as safety shut off valve boxes. They have been designed to increase both the flexibility of the system, but also to enable the system to comply with the requirements of IEC60335-2-40 and EN378. To enable this compliance, both the Flow Selector (F/S) and Shut Off Valve (SV) boxes have been fitted with isolation valves



Hi - Res Image 

Shut-Off-Valve	RBM-	SV1121HUPE	SV1801HUPE
Height x Width x Depth	mm	206 x 385 x 282	206 x 385 x 282
Weight	kg	10	10
Standard 5 Core Control Cable Max. Length	m	≤ 300	≤ 300
Standard 3 Core Power Cable Max. Length	m	≤ 50	≤ 50
Power Supply From Local or Group Indoor Unit	V/ph/Hz	230/240-1-50	230/240-1-50
Suggested Fused Supply	A	6	6

### Single Unit Connection For Flow Selector

MM*-UP***		003 to 012	015 to 018	024 to 030	036 to 056	072 to 112
Indoor Unit Side Gas Pipe	inch	3/8	1/2	5/8	5/8	7/8
Indoor Unit Side Liquid Pipe	inch	1/4	1/4	3/8	3/8	1/2
Outdoor Unit Side Suction Gas Pipe	inch	5/8	5/8	5/8	5/8	7/8
Outdoor Unit Side Liquid Pipe	inch	3/8	3/8	3/8	3/8	1/2
Max. Pipe Length To Indoor Unit	m	50	50	50	50	50

### Multi Unit Connection For Flow Selector

Indoor unit capacity code		Less than 4 hp	4 hp or more Less than 6.4 hp
Indoor Unit Side Gas Pipe	inch	5/8	5/8
Indoor Unit Side Liquid Pipe	inch	3/8	3/8
Outdoor Unit Side Suction Gas Pipe	inch	5/8	5/8
Outdoor Unit Side Discharge Gas Pipe	inch	3/8	3/8
Outdoor Unit Side Liquid Pipe	inch	6	10
Max. Connectable Indoor Units		50	50
Max. Total Pipe Length	m	40	40
Max. Height Difference Between Indoor Units	m	15	15

\*All [Accessories](#) / [Controls](#)

Related items - **SV1121HUPE:**

- [Full specification](#)
- [BIM files](#)
- [CAD files](#)
- [Dimensional drawing](#)
- [Wiring diagram](#)
- [Installation manual](#)

Related items - **SV1801HUPE:**

- [Full specification](#)
- [BIM files](#)
- [CAD files](#)
- [Dimensional drawing](#)
- [Wiring diagram](#)
- [Installation manual](#)



## VRF SHRMa R32: Multi flow selector boxes

Toshiba have designed a new range of single & multi flow selector boxes as well as safety shut off valve boxes. They have been designed to increase both the flexibility of the system, but also to enable the system to comply with the requirements of IEC60335-2-40 and EN378. To enable this compliance, both the Flow Selector (F/S) and Shut Off Valve (SV) boxes have been fitted with isolation valves

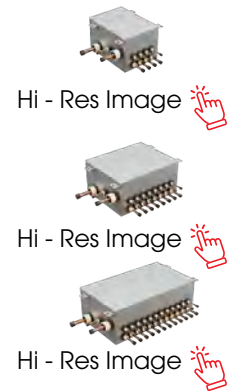

Multi Flow Selector Unit	RBM-	Y1801FU4PE	Y1801FU8PE	Y1801FU12PE
Height x Width x Depth	mm	293 x 338 x 468	293 x 578 x 468	293 x 818 x 468
Weight	kg	22	36	50
Number of Ports		4	8	12
Max. Connectable Indoor Units per Port		10	10	10
Max. Connectable Indoor Units		40	80	120
Max. Pipe Length from Single Port	m	50	50	50
Max. Total Pipe Length from All Ports	m	120	180	180
Max. Height Difference Between Indoor Units	m	15	15	15
Power Supply	V-ph-Hz	230/240-1-50	230/240-1-50	230/240-1-50
Suggested Fused Supply	A	6	6	10

Single Unit Connection For Flow Selector		003 to 012	015 to 018	024 to 030	036 to 056	072 to 112
<b>MM*-UP***</b>						
Indoor Unit Side Gas Pipe	inch	3/8	1/2	5/8	5/8	7/8
Indoor Unit Side Liquid Pipe	inch	1/4	1/4	3/8	3/8	1/2
Outdoor Unit Side Suction Gas Pipe	inch	1 1/8	1 1/8	1 1/8	1 1/8	1 1/8
Outdoor Unit Side Discharge Gas Pipe	inch	7/8	7/8	7/8	7/8	7/8
Outdoor Unit Side Liquid Pipe	inch	1/2	1/2	1/2	1/2	1/2
Max. Pipe Length To Indoor Unit	m	120	120	120	180	180

Multi Unit Connection For Flow Selector		Below 25.6	Below 38.4	Below 38.4
Indoor unit capacity code				
Indoor Unit Side Gas Pipe	inch	5/8	5/8	5/8
Indoor Unit Side Liquid Pipe	inch	3/8	3/8	3/8
Outdoor Unit Side Suction Gas Pipe	inch	1 1/8	1 1/8	1 1/8
Outdoor Unit Side Discharge Gas Pipe	inch	7/8	7/8	7/8
Outdoor Unit Side Liquid Pipe	inch	1/2	1/2	1/2
Max. Total Pipe Length	m	120	180	180
Max. Height Difference Between Indoor Units	m	15	15	15

\*All [Accessories](#) / [Controls](#)

Related items - **Y180FU4PE:**

- [Full specification](#)
- [BIM files](#)
- [CAD files](#)
- [Dimensional drawing](#)
- [Wiring diagram](#)
- [Installation manual](#)

Related items - **Y1801FU8PE:**

- [Full specification](#)
- [BIM files](#)
- [CAD files](#)
- [Dimensional drawing](#)
- [Wiring diagram](#)
- [Installation manual](#)

Related items - **Y1801FU12PE:**

- [Full specification](#)
- [BIM files](#)
- [CAD files](#)
- [Dimensional drawing](#)
- [Wiring diagram](#)
- [Installation manual](#)



## VRF SHRMa R32: Leak Detector & Battery Kit

Toshiba have designed a new range of single & multi flow selector boxes as well as safety shut off valve boxes. They have been designed to increase both the flexibility of the system, but also to enable the system to comply with the requirements of IEC60335-2-40 and EN378. To enable this compliance, both the Flow Selector (F/S) and Shut Off Valve (SV) boxes have been fitted with isolation valves



Leak detection Sensor	TCB-	LD1UPE
Power Supply	V (DC)	Indoor A/B - 13V to 18V
Dimensions (H x W x D)	mm	120 x 86 x 30
Total Weight	Kg	0.11
Temp / Humidity range	°C	0°C to 40°C / 20% to 80% (Indoor use only)
Sensor Type		Resistance Value
Buzzer sound level	dB (A)	65 at 1m
Activation Point	ppm	>5000
Expected Service Life		10 Years
Test / inspection mode		Available
Alert methods		Audible and Visual
External Outputs		2 x Available (CN64 & CN65)
Legislation Compliance		IEC60335-2-40 (Part GG.13 & Annex LL)
Error codes generated		J31 - Product life span has exceeded limit
		J30 - Refrigerant Leak detected
		J29 - Leak sensor failure / break down



Hi - Res Image

### Related items:

- [Full specification](#)
- [BIM files](#)
- [Dimensional drawing](#)
- [Wiring diagram](#)
- [Installation manual](#)



Battery Pack	TCB-	BT1UPE
Power Supply		Input: 12V, 600mA / Output: 12V, 550mA
Dimensions (H x W x D)	mm	51 x 176 x 72
Total Weight	Kg	0.7
Estimated charge time		2 Hours (From complete discharge)
Battery Type		Nickel metal hydride battery
No. of operations from full before exhausted		Single Port Flow Selector = 12
		Shut off valve = 6
		Multi port flow selectors = 4
Expected Service Life		5 Years
End of life Notice Code		203 (Change required / Operating hours exceeded)
Storage Temp condition < 1 Year	°C	-20 to +55 Dry Bulb / RH = 65%
Storage Temp condition > 1 Year	°C	-20 to +55 Dry Bulb / RH = 65%
Legislation Compliance		IEC60335-2-40 (Part GG.12.2)



Hi - Res Image

### Related items:

- [BIM files](#)
- [Dimensional drawing](#)
- [Installation manual](#)

























# SHRM

SUPER HEAT RECOVERY MULTI  
A D V A N C E

# CONTROLS & ACCESSORIES















## CONTROLS

	Image	Model Reference	Application	Description	Related Items
Wireless Controllers		RBC-AX33UYP-E	1-Way Cassette (YHP)	Wireless receiver kit	<a href="#">Installation Manual</a> <a href="#">Owners Manual</a>
		RBC-AX41U(W)-E	4-Way Compact Cassette	Wireless infra-red controller and receiver	<a href="#">Installation Manual</a>
		RBC-AXU31C-E	Ceiling Receiver	Wireless remote controller kit	<a href="#">Installation Manual</a> <a href="#">Owners Manual</a>
		RBC-AXU33UP-E	4-Way Standard Cassette	Wireless remote controller kit	<a href="#">Installation Manual</a> <a href="#">Owners Manual</a>
		RBC-AXU33UPB-E	4-Way Standard Cassette	Wireless remote controller kit - Black panel	<a href="#">Installation Manual</a> <a href="#">Owners Manual</a>
		RBC-AXU31U-E	4-Way Standard Cassette	Wireless receiver kit	<a href="#">Installation Manual</a> <a href="#">Owners Manual</a>
		RBC-AXU31UM-E	4-Way Compact Cassette	Wireless receiver kit	<a href="#">Installation Manual</a> <a href="#">Owners Manual</a>
		RBC-AXU31UW-E	2-Way Cassette	Wireless receiver kit	<a href="#">Installation Manual</a> <a href="#">Owners Manual</a>
		RBC-AXU41U-E	4-Way Smart Cassette	Wireless receiver kit	<a href="#">Installation Manual</a> <a href="#">Owners Manual</a>
		RBC-AXU31-E	External Receiver	Wireless remote controller kit - others (excludes High Static Duct)	<a href="#">Installation Manual</a> <a href="#">Owners Manual</a>
		TCB-AX32E2	External Receiver	Independent receiver and remote controller for all models	<a href="#">Installation Manual</a> <a href="#">Owners Manual</a>
Occupancy Sensors		TCB-SIR41U-E	4-Way Smart Cassette	Occupancy sensor control with 10m diameter detection	<a href="#">Installation Manual</a>
		TCB-SIR41UM-E	4-Way Compact Cassette	Occupancy sensor control with 10m diameter detection	<a href="#">Installation Manual</a>
		TCB-SIR33UP-E	Highwall	Occupancy Sensor Kit	<a href="#">Installation Manual</a> <a href="#">Owners Manual</a>
		TCB-SIR41UYP-E	1-Way Cassette	Occupancy sensor control with 10m diameter detection	<a href="#">Installation Manual</a> <a href="#">Owners Manual</a>
Wired Controllers		RBC-AMTU31-E	Standard Remote Controller	Full control including service functions	<a href="#">Installation Manual</a> <a href="#">Owners Manual</a>
		RBC-ASCU11-E	Compact Remote Controller	Includes timer off, back light display with easy use functions, multilingual	<a href="#">Installation Manual</a> <a href="#">Owners Manual</a>
		RBC-AMSU51-ES	Remote Controller	Includes energy monitoring, timer and back light display as well as power save functions, multilingual	<a href="#">Installation Manual</a> <a href="#">Owners Manual</a>
		RBC-AWSU52-E	Remote Controller	Bluetooth functionality, dual set point control, refrigerant leak detection indication, 7-Day timer, soft cooling, energy saving options and return back function	<a href="#">Installation Manual</a> <a href="#">Owners Manual</a>
		RBC-AMSU52-E	Remote Controller	Dual set point control, refrigerant leak detection indication, 7-Day Timer, multilingual LCD display with back light, soft cooling, energy saving options and return back function	<a href="#">Installation Manual</a> <a href="#">Owners Manual</a>
		RBC-MTSC1	Mini Touch Screen Controller	Mini touch screen controller with configurable icons for indoor units	<a href="#">Installation Manual</a>
		RBC-MTSC2	Mini Touch Screen Controller	Mini touch screen controller with schedule timer, configurable icons for indoor units	<a href="#">Installation Manual</a>
		NRC-01HE	Remote Controller	VN-M150-2000HE air to air heat exchangers	<a href="#">Installation Manual</a>



## CONTROLS

	Image	Model Reference	Application	Description	Related Items
Wired Central Controllers		BMS-CT1280E	Touch Screen Controller	Enables full control of up to 128 indoor units with energy monitoring and advanced control options (requires configuration support subject at extra cost)	<a href="#">Installation Manual</a> <a href="#">Owners Manual</a>
		BMS-CT5121E	Touch Screen Controller	Multi function Touch Screen Controller enables full control of up to 512 indoor units with electric billing	<a href="#">Installation Manual</a> <a href="#">Owners Manual</a>
		BMS-CT2560U-E	Touch Screen Controller	Multi function Touch Screen Controller enables full control of up to 256 indoor units with electric billing	<a href="#">Installation Manual</a> <a href="#">Owners Manual</a>
		BMS-IFBN1281U-E	BACnet Control	Interface for SMMSu / SHRMa	<a href="#">Installation Manual</a> <a href="#">Owners Manual</a>
		BMS-IWF0010UCP-E	Smart Device control interface	Enables full control of up to 32 indoor units by smart device with Toshiba AC app (local smart phone & tablet)	
		RBC-BP2	Black Pear Controller	Controls up to 64 indoor units BACnet/Modbus/Trend	
		RBC-TBPTS	Touch Screen Controller	Multi function Touch Screen Controller	<a href="#">Installation Manual</a>
		RBC-TBPTSBC	Toshiba Smart Touch Back Box	Recessed housing for smart Touch Screen Controller	
		TCB-SC640U-E	Central Controller ON/OFF	Full control of max 64 indoor units standard features on/off, mode, temperature setting, fan speed, louvres, permit/prohibit functions with touch-sensitive keys	<a href="#">Installation Manual</a> <a href="#">Owners Manual</a>
Control Panel		RBC-AC1	Auto-Changeover Panel	Unit auto-changeover with temperature high limit stat (1 Run/1 Standby)	<a href="#">Data Sheet</a>
		RBC-AC2	Auto-Changeover Panel	Unit auto-changeover with temperature high limit stat (2 Run/1 Standby)	<a href="#">Data Sheet</a>
Control Software		Embedded 2	Interactive intelligence	NEW Interactive intelligence controller	Contact Toshiba
		*Embedded 2 software	Interactive intelligence	*Embedded 2 software	
		TTS-WP1SC	Interactive intelligence	Toshiba Embedded 2 software configuration	
Indoor Interface		BMS-IFKX0UCW-E	BMS Interface	KNX I/F VRF	
		BMS-IFMB640U-E	BMS Interface	Modbus I/F VRF	
		BMS-IFMB0UCW-E	BMS Interface	Modbus I/F VRF	
		TCB-TC41U-E	Remote Sensor	Ideal for allowing automatic control but room sensing required for comfort	<a href="#">Installation Manual</a>
		RBC-AVS2	Remote Sensor	Averaging temperature sensor kit	<a href="#">Installation Manual</a>
		RBC-AVS3	Remote Sensor	Averaging temperature sensor kit	<a href="#">Installation Manual</a>
		RBC-AVS4	Remote Sensor	Averaging temperature sensor kit	<a href="#">Installation Manual</a>
		RBC-SMF1	Fan Interface	Interface to provide an output to enable an external fan from the unit	<a href="#">Installation Manual</a>

## CONTROLS













































	Image	Model Reference	Application	Description	Related Items
Indoor Interface (Continued)		RBC-SMIM2	Indicator Module Mode	Interface to indicate the mode of unit operation output for cool, heat and fan only	
		RBC-SMIM3	Indicator Module ON/OFF & Stopping Fault	Interface to indicate unit operation and stopping fault	<a href="#">Installation Manual</a>
		RBC-SMIM4	Indicator Module ON/OFF, Stopping Fault & Unit Enable	Interface to indicate unit operation and stopping fault and connections to enable the unit	<a href="#">Installation Manual</a>
		RBC-TO-RC-WIFI-1	Wi-Fi Connection	IntesisHome Wi-Fi - Toshiba DI and VRF	Contact Intesis
		RBC-TS1	Monitoring & Control Interface	Interface to connect 0-10v or resistance based BMS	<a href="#">Installation Manual</a>
		RBC-TXIO	Control Interface	Input/output interface for third-party equipment	
		TCB-PX40MUME	Enclosure	Control Box for Interface PCB's	
		TCB-IFCB5-PE	Window Switch & Remote ON/OFF	Disable indoor unit operation when outside window is open and for door entry system	<a href="#">Installation Manual</a>
		TCB-PX100-PE	Enclosure for Window Switch	Use when the window switch cannot fit within the AC unit	
		TCB-PX30MUE	Enclosure	Terminal Box for TCB-PCNT30TLE2	<a href="#">Installation Manual</a>
		TCB-PCNT30TLE2	Connection interface	1 to 1 model connection interface	<a href="#">Installation Manual</a>

	Image	Model Reference	Application	Description	Related Items
Leak Detection		TQ31	Leak detection sensor	Contact TQ Environmental ( <a href="https://tqplc.com">https://tqplc.com</a> )	<a href="#">Data Sheet</a>
		TQ32	Area Alarm Panel	Contact TQ Environmental ( <a href="https://tqplc.com">https://tqplc.com</a> )	<a href="#">Data Sheet</a>
		TQ35	Central Alarm Panel	Contact TQ Environmental ( <a href="https://tqplc.com">https://tqplc.com</a> )	<a href="#">Data Sheet</a>
		TCB-LDS1	Refrigerant Leak Detector	Room leak detection concentration sensor with white faceplate (requires remote 12v transformer)	<a href="#">Installation Manual</a>
		TCB-LDS2	Refrigerant Leak Detector	Room leak detection concentration sensor with stainless steel faceplate (requires remote 12v transformer)	<a href="#">Installation Manual</a>
		TCB-LDS1BLK	Refrigerant Leak Detector	Room leak detection concentration sensor with black faceplate (requires remote 12v transformer)	<a href="#">Installation Manual</a>
		TCB-LD12V	Refrigerant Leak Detector	Room leak detection transformer 12v and cable kit (use with TCB-LDS1 & TCB-LDS2)	<a href="#">Installation Manual</a>
		TCB-LD1	Area Alarm Panel	Leak Detection for SMMSe/SHRMe	<a href="#">Installation Manual</a>
		TCB-LD2	Area Alarm Panel	Leak Detection for SMMSe/SHRMe (No Valves)	<a href="#">Installation Manual</a>
		RBC-LDCIMC	Refrigerant Leak Detector	Leak detection 15m lead	

## CONTROLS

	Image	Model Reference	Application	Description	Related Items
Indoor Interface Lead		RBC-CBK15FE	Flow Selector Lead 15M	Extension lead kit for the flow selector	
		RBC-FSEX15	Flow Selector Lead 15M	Extension lead kit for the flow selector	
		RBC-IT4-PE	CN06 Connector Timer Interface	Interface to accept a 240v input from a timer	
		RBC-SMCN61	ON/OFF And Locking Lead	Lead to remotely switch a unit on/off and to lock this function	<a href="#">Installation Manual</a>
		RBC-SMCN61L	ON/OFF Lock Lead	Lead to lock the on/off function	<a href="#">Installation Manual</a>
		RBC-SMT1	CN02 Connector Timer Interface Lead	Lead to provide on/off control from the RBC-AMT32E remote or any central controller	<a href="#">Installation Manual</a>
		RBC-VNL1	CN705 Unit Interface Lead 1.5M	VN-M150-2000HE external 0v contact closure for on/off local controller lock, increase fan speed and damper position	<a href="#">Installation Manual</a>
		TCB-KBCN32VEE	Connector for CN 32	Ventilation fan control DI & VRF	<a href="#">Installation Manual</a>
		TCB-KBCN60OPE	CN60 Operation Status	Operation status for indoor unit DI & VRF	<a href="#">Installation Manual</a>
		TCB-KBCN61HAE	Connector for CN 61	On/off control DI & VRF	<a href="#">Installation Manual</a>
		TCB-KBCN70OAE	Connector for CN 70	Option error input DI & VRF	<a href="#">Installation Manual</a>
		TCB-KBCN73DEE	Connector for CN 73	Option error input DI & VRF	<a href="#">Installation Manual</a>
		TCB-KBCN80EXE	Connector for CN 80	External error input DI & VRF	<a href="#">Installation Manual</a>
Interface		BMS-IFDD03E	Digital Input/Output Relay Interface	Interface for: Touch Screen Controller; compliant manager; web based controller; smart manager; power meter device; 4 x digital outputs & 8 digital inputs	<a href="#">Installation Manual</a>
		BMS-IFWH5E	Power Meter Interface	Energy monitoring relay interface for up to 8 pulse power meters Touch Screen Controller, compliant manager, web based controller, smart manager	<a href="#">Installation Manual</a>
		RBC-IT4-PE	Timer Interface	External Interface (240v Switching)	
		TCB-IFCB640TLE	Analogue Interface	Control & monitoring up to 64 indoor units on TCC-link	<a href="#">Installation Manual</a>
		TCB-IFCG1TLE	General Purpose Interface	Enables control of A/C by the DI/DO and AI/AO	<a href="#">Installation Manual</a> <a href="#">Owners Manual</a>
		TCB-IFLN642TLE	LonWorks Gateway	LonWorks interface	<a href="#">Installation Manual</a>
		TCB-IFMB1280U-E	Modbus Gateway	Connect the system to a Modbus building management system	
		TCB-PCUC2E	Indoor Control Interface	Application control kit	<a href="#">Installation Manual</a>

## CONTROLS

	Image	Model Reference	Application	Description	Related Items
Outdoor Interface		TCB-IFCB-4E2	CN61 Remote ON/OFF	Interface for remote on/off	<a href="#">Installation Manual</a>
		TCB-PCDM4E	Power Peak -Cut Control	Power peak-cut control	<a href="#">Installation Manual</a>
		TCB-PCIN4E	CN511 Operation Output Display	Operation/error output display, compressor operation control	<a href="#">Installation Manual</a>
		TCB-PCMO4E	CN150-508-512 Operation Control	CN150 operation mode control; CN508 night set back control; CN508 snowfall fan control; CN512 external master on/off	<a href="#">Installation Manual</a>
		TCB-PCOS1E2	Application control sensor kit	Enables night operation control, demand control and operation monitoring	
		TCB-SS1UU-E	SMMSu/SHRMa Link Adapter	Link Adapter with 8GB MicroSD Card	<a href="#">Owners Manual</a>
		TCB-DK01SS-E	Link Adapter	Dyna Doctor Hardware	<a href="#">Owners Manual</a>

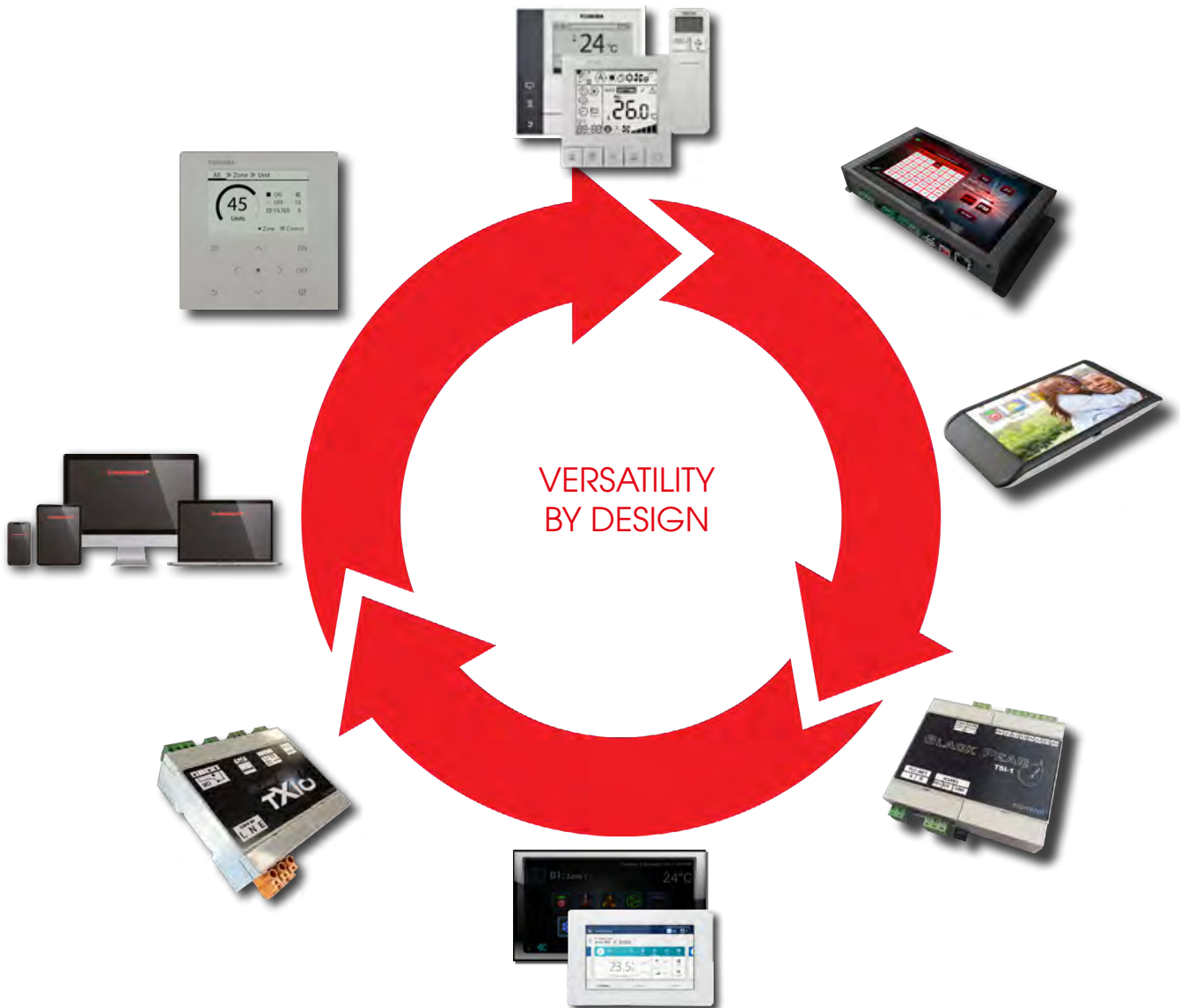

## ACCESSORIES

### PIPING KITS

Pulse Modulating Valve Kit	Image	Model Reference	Application	Description	Related Items
		RBM-PMV0363E	PMV	VRF 2-Pipe Valve Kit (models 3-12)	<a href="#">Installation Manual</a>
		RBM-PMV0903E	PMV	VRF 2-Pipe Valve Kit (models 15-24)	<a href="#">Installation Manual</a>
		RBM-PMV0361U-E	PMV	VRF 2-Pipe Valve Kit (models 3-12)	<a href="#">Installation Manual</a>
		RBM-PMV0901U-E	PMV	VRF 2-Pipe Valve Kit (models 15-24)	<a href="#">Installation Manual</a>
		RBM-PMV0361UP-E	PMV	VRF 2-Pipe Valve Kit (models 3-12)	<a href="#">Installation Manual</a>
	RBM-PMV0901UP-E	PMV	VRF 2-Pipe Valve Kit (models 15-34)	<a href="#">Installation Manual</a>	
Elbow & pump kits	Image	Model Reference	Application	Description	Related Items
		TCB-KP14CPE	Elbow Piping Kit	Ceiling Suspended Elbow Piping Kit (1.5 - 2.0hp)	
		TCB-KP24CPE	Elbow Piping Kit	Ceiling Suspended Elbow Piping Kit (2.5 - 5.0hp)	
		TCB-DP31CE	Drain pump kit	Ceiling Suspended drain pump kit	<a href="#">Installation Manual</a>
	TCB-DP40DPE	Drain pump kit	High static duct drain pump kit	<a href="#">Installation Manual</a>	
Branch Joints	Image	Model Reference	Application	Description	Related Items
		RBM-BT14E	VRF CDU 2-Pipe Modular Kit	SMMS capacities below 26HP	<a href="#">Installation Manual</a>
		RBM-BT24E	VRF CDU 2-Pipe Modular Kit	SMMS capacities above 26HP	<a href="#">Installation Manual</a>
		RBM-BT34E	VRF CDU 2-Pipe Modular Kit	SMMS capacities above 46HP	<a href="#">Installation Manual</a>
		RBM-BT14FE	VRF CDU 3-Pipe Modular Kit	SHRM capacities below 26HP	<a href="#">Installation Manual</a>
	RBM-BT24FE	VRF CDU 3-Pipe Modular Kit	SHRM capacities above 26HP	<a href="#">Installation Manual</a>	

## ACCESSORIES

### PIPING KITS





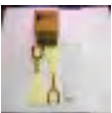











	Image	Model Reference	Application	Description	Related Items
Headers		RBM-HY1043E	VRF 2-Pipe 4-Way Header	SMMS capacities below 14.2HP	<a href="#">Installation Manual</a>
		RBM-HY2043E	VRF 2-Pipe 4-Way Header	SMMS capacities 14.2 - 25.2HP	<a href="#">Installation Manual</a>
		RBM-HY1083E	VRF 2-Pipe 8-Way Header	SMMS capacities below 14.2HP	<a href="#">Installation Manual</a>
		RBM-HY2083E	VRF 2-Pipe 8-Way Header	SMMS capacities 14.2 - 25.2HP	<a href="#">Installation Manual</a>
		RBM-HY1043FE	VRF 3-Pipe 4-Way Header	SHRM capacities below 6.4HP	<a href="#">Installation Manual</a>
		RBM-HY2043FE	VRF 3-Pipe 4-Way Header	SHRM capacities 6.4 - 14.2HP	<a href="#">Installation Manual</a>
		RBM-HY1083FE	VRF 3-Pipe 8-Way Header	SHRM capacities 14.2 - 25.2HP	<a href="#">Installation Manual</a>
		RBM-HY2083FE	VRF 3-Pipe 8-Way Header	SHRM capacities above 25.2HP	<a href="#">Installation Manual</a>

	Image	Model Reference	Application	Description	Related Items
Y-Joints		RBM-BY55E	VRF 2-Pipe Y Joint	SMMS capacities below 6.4HP	<a href="#">Installation Manual</a>
		RBM-BY105E	VRF 2-Pipe Y Joint	SMMS capacities 6.4 - 14.2HP	<a href="#">Installation Manual</a>
		RBM-BY205E	VRF 2-Pipe Y Joint	SMMS capacities 14.2 - 25.2HP	<a href="#">Installation Manual</a>
		RBM-BY305E	VRF 2-Pipe Y Joint	SMMS capacities above 25.2HP	<a href="#">Installation Manual</a>
		RBM-BY405E	VRF 2-Pipe Y Joint	SMMS capacities above 61.2HP	
		RBM-BY55FE	VRF 3-Pipe Y Joint	SHRM capacities below 6.4HP	<a href="#">Installation Manual</a>
		RBM-BY105FE	VRF 3-Pipe Y Joint	SHRM capacities 6.4 - 14.2HP	<a href="#">Installation Manual</a>
		RBM-BY205FE	VRF 3-Pipe Y Joint	SHRM capacities 14.2 - 25.2HP	<a href="#">Installation Manual</a>
		RBM-BY305FE	VRF 3-Pipe Y Joint	SHRM capacities above 25.2HP	<a href="#">Installation Manual</a>

## ACCESSORIES

### MISCELLANEOUS

Image	Model Reference	Application	Description	Related Items
	RBC-VCK1	Vertical Conversion Kit	Standard Ducted Indoor Unit Conversion To Vertical Mount	Contact Toshiba
	RBM-FGUS1P-E	SMMSu/SHRMa	Fin Guard Option kit (08 - 14HP)	
	RBM-FGUM1P-E	SMMSu/SHRMa	Fin Guard Option kit (16 - 24HP)	
	TCB-BC1603UE	Air Discharge Direction Kit	4-Way Cassette Air Outlet Shield for 2 or 3-Way Blow	<a href="#">Installation Manual</a>
	TCB-SP1603UE	Cassette Spacer	4-Way Cassette Height Spacer for RBC-U41PG(W)E	<a href="#">Installation Manual</a>
	TCB-FF101URE2	Inlet Spigot	Compact Cassette Auxiliary Fresh Air Flange	<a href="#">Installation Manual</a>
	TCB-FF151US-E	Inlet Spigot	2-Way Cassette Auxiliary Fresh Air Flange	<a href="#">Installation Manual</a>
	TCB-GB1602UE	Inlet Spigot	4-Way Cassette Auxiliary Fresh Air Flange	<a href="#">Installation Manual</a>
	TCB-GB1602UE2	Inlet Spigot	4-Way Cassette Auxiliary Fresh Air Flange	<a href="#">Installation Manual</a>
	TCB-SF56C6BPE	Discharge Spigots 2 X 200mm	Ducted (0.8-2HP)	<a href="#">Installation Manual</a>
	TCB-SF80C6BPE	Discharge Spigots 3 X 200mm	Ducted (2.5-3.2HP)	<a href="#">Installation Manual</a>
	TCB-SF160C6BPE	Discharge Spigots 4 X 200mm	Ducted (4-6HP)	<a href="#">Installation Manual</a>
	TCB-EAPC1UYHP-E	1-Way Cassette	Air Purifier Kit	<a href="#">Installation Manual</a> <a href="#">Owners Manual</a>
	TCB-TDL0141SDY-E	Diffuser	3D Diffuser for Slim Ducted ( 3 to 12)	<a href="#">Installation Manual</a> <a href="#">Owners Manual</a>
	TCB-TDL0181SDY-E	Diffuser	3D Diffuser for Slim Ducted (15 to 18)	<a href="#">Installation Manual</a> <a href="#">Owners Manual</a>
	TCB-TDL0271SDY-E	Diffuser	3D Diffuser for Slim Ducted (24 to 27)	<a href="#">Installation Manual</a> <a href="#">Owners Manual</a>
	TCB-FC1403UW-E	Filter Chamber	2-Way Cassette Filter Chamber (*0362-0562)	<a href="#">Installation Manual</a>
	TCB-FC283UW-E	Filter Chamber	2-Way Cassette Filter Chamber (*0072-0152)	<a href="#">Installation Manual</a>
	TCB-FC803UW-E	Filter Chamber	2-Way Cassette Filter Chamber (*0182-0302)	<a href="#">Installation Manual</a>
	TCB-FC0481DF-E	Filter Chamber	Fresh Air Intake Filter Chamber (*0481)	<a href="#">Installation Manual</a>
	TCB-FC1281DF-E	Filter Chamber	Fresh Air Intake Filter Chamber (*0721-0961)	<a href="#">Installation Manual</a>
	TCB-GFC1603U-E	Filter Chamber	4-Way Cassette Fresh Air & Filter Chamber	Installation Manual
	TCB-LF1403UW-E	Long Life Filter	2-Way Cassette Super Long Life Pre-Filter (*0362-0562)	<a href="#">Installation Manual</a>
	TCB-LF283UW-E	Long Life Filter	2-Way Cassette Super Long Life Pre-Filter (*0072-0152)	<a href="#">Installation Manual</a>
	TCB-LF803UW-E	Long Life Filter	2-Way Cassette Super Long Life Pre-Filter (*0182-0302)	<a href="#">Installation Manual</a>

Air Discharge, Filtration & Inlet

## ACCESSORIES

### MISCELLANEOUS

	Image	Model Reference	Application	Description	Related Items
Air Discharge, Filtration & Inlet (Continued)		TCB-LK801D-E	Long Life Filter	Ducted Long Life Filter Kit (2-3hp)	<a href="#">Installation Manual</a>
		TCB-LK1401D-E	Long Life Filter	Ducted Long Life Filter Kit (4-6hp)	<a href="#">Installation Manual</a>
		TCB-LK2801DP-E	Long Life Filter	Ducted Long Life Filter Kit (8-10hp)	<a href="#">Installation Manual</a>
		TCB-PF0481DF-E	Long Life Filter	High Static Ducted Long Life Pre-Filter (Qty required: *0481 x 2)	
		TCB-PLFC2UPE-80	Filter Kit	PM2.5 After Pre-filter 4-Way Cassette (6 x filters)	<a href="#">Installation Manual</a>
		TCB-PLFC1UPE-120	Filter Kit	PM2.5 Before Pre-filter 4-Way Cassette (4 x filters)	<a href="#">Installation Manual</a>
		TCB-UFM0481D-E	High Efficiency Filter	Fresh Air Intake High-Efficiency Filter 65% (Qty required: *0481 x 2)	
		TCB-UFH0481D-E	High Efficiency Filter	Fresh Air Intake High-Efficiency Filter 90% (Qty required: *0481 x 2)	
		TCB-PF1281DF-E	Long Life Filter	High Static Ducted Long Life Pre-Filter (Qty required: *0721-0961 x 2)	
		TCB-UFM1281D-E	High Efficiency Filter	Fresh Air Intake High-Efficiency Filter 65% (Qty required: *0721-*1281 x 2)	
		TCB-UFH1281D-E	High Efficiency Filter	Fresh Air Intake High-Efficiency Filter 90% (Qty required: *0721-*1281 x 2)	
		TCB-EAPC1UHP-E	Air Purifier Kit	Ionizer + Dust Filter + Dust Sensor + Remote	<a href="#">Installation Manual</a> <a href="#">Owners Manual</a>
		TCB-EABC1UHP-E	Air Purifier Kit	Ionizer + Dust Filter + Remote	<a href="#">Installation Manual</a> <a href="#">Owners Manual</a>

	Image	Model Reference	Application	Description	Related Items
VN Heater Kits/Controls & Filters		RBC-VNMC-PE	Heater Controller Kit	Control for VN-U00151/01001SY-E Heater Kits	<a href="#">Installation Manual</a>
		RBC-VNMH1	100mm Heater Kit 1kW	(For VN-U00151SY-E)	<a href="#">Installation Manual</a>
		RBC-VNMH2	150mm Heater Kit 1kW	(For VN-U00151SY-E/VN-U00351SY-E)	<a href="#">Installation Manual</a>
		RBC-VNMH3	200mm Heater Kit 2 X 1kW	(For VN-U00501SY-E/VN-U00651SY-E)	<a href="#">Installation Manual</a>
		RBC-VNMH4	250mm Heater Kit 2 X 1kW	(For VN-U00801SY-E/VN-U01001SY-E)	<a href="#">Installation Manual</a>
		TCB-SFMC1V-E	CO <sub>2</sub> Sensor	Multi function sensor (all models)	New Kit not available yet
		TCB-PSFC55VSY-E	EPM1 Filter	EMP1 55% High Performance Filter (151, 251)	New Kit not available yet
		TCB-PSFC55VMY-E	EPM1 Filter	EMP1 55% High Performance Filter (351)	New Kit not available yet
		TCB-PSFC55VLY-E	EPM1 Filter	EMP1 55% High Performance Filter (501, 651)	New Kit not available yet
		TCB-PSFC55VXY-E	EPM1 Filter	EMP1 55% High Performance Filter (801, 1001)	New Kit not available yet



## ACCESSORIES

### MISCELLANEOUS



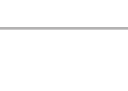



	Image	Model Reference	Application	Description	Related Items
Painted Finish		PAINT-4WAYCASSETTE	4-Way Cassette	Painted Cassette Unit Chassis	Contact Toshiba
		Paint-Ducted 07-18	Ducted	Painted Ducted Unit Chassis	
		Paint-Ducted 24-30	Ducted	Painted Ducted Unit Chassis	
		Paint-Ducted 36-56	Ducted	Painted Ducted Unit Chassis	
		PAINT-U21FP	Compact Cassette	Painted Compact Cassette Facia Panel	
		PAINT-U31FP	4-Way Cassette	Painted 4-Way Cassette Facia Panel	







	Image	Model Reference	Application	Description
Fabric Covers		RB-I4101-E	Premium Highwall (HAORI)	Dark Grey
		RB-I4102-E	Premium Highwall (HAORI)	Light Grey
		RB-I4103-E	Premium Highwall (HAORI)	Bluish Grey
		RB-I4104-E	Premium Highwall (HAORI)	Grey Beige
		RB-I4105-E	Premium Highwall (HAORI)	Dark Brown
		RB-I4106-E	Premium Highwall (HAORI)	Emerald Blue

	Image	Model Reference	Application	Description	Related Items
Anti-Corrosion Coatings		CACC-VRF	VRF Module CDU Coil Anti-Corrosion Coating	8HP - 14HP SMMS, 8HP - 10HP SHRM	Contact Toshiba
		CACC-VRF1	VRF Module CDU Coil Anti-Corrosion Coating	16HP - 24HP SMMS, 12HP - 14HP SHRM	
		CACC-VRF2	VRF Module CDU Coil Anti-Corrosion Coating	16HP - 20HP SHRM	

	Image	Model Reference	Application	Description	Related Items
Split Case/Sections		TTS-VRFSD-ML	Split Case 2 Main Sections	Painted Cassette Unit Chassis	Contact Toshiba
		TTS-VRFSD-OS	Split Case 2 Main Sections	Painted Ducted Unit Chassis	
		TTS-VRFSD-MLF	Split Case Multiple Sections	Painted Ducted Unit Chassis	
		TTS-VRFSD-OSF	Split Case Multiple Sections	Painted Ducted Unit Chassis	

	Image	Model Reference	Application	Description	Related Items
Site Services		TTS-VRFSCA	Technical Support	Toshiba VRF system commissioning assistance	Contact Toshiba

## BROCHURES



Download brochures

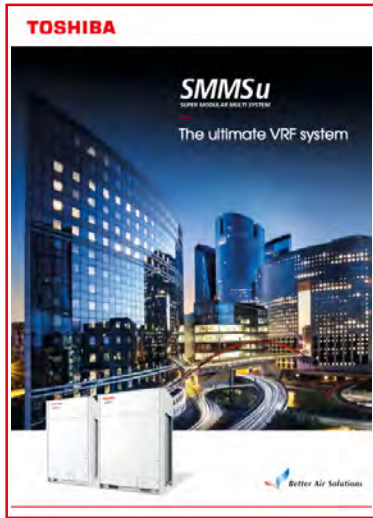

## Office Locations



## Cool Designs Ltd Office Locations

**Warrington**  
16/17 Cranford Court  
Hardwick Grange  
Woolston  
Warrington  
WA1 4RX  
Tel: 01925 820000  
www.cdlweb.info  
sales@cooldesignsltd.co.uk

**Gateshead (Head Office)**  
South Shore Road  
Gateshead  
NE8 3AE  
Tel: 0191 5496964  
www.cdlweb.info  
sales@cooldesignsltd.co.uk

**Glasgow**  
Unit 3 Glenburn Court  
College Milton  
East Kilbride  
Glasgow  
G74 5BA  
Tel: 01355 234776  
www.cdlweb.info  
sales@cooldesignsltd.co.uk

## Toshiba Office Locations

**Leatherhead**  
Toshiba Air Conditioning  
Elite House  
Guildford Road  
Leatherhead  
Surrey  
KT22 9UT  
Tel: 0330 236 8630  
marketing.uk@toshiba-ac.com

**Manchester**  
Toshiba Air Conditioning  
Unit 15 S:Park Business Park  
Hamilton Road  
Stockport  
Greater Manchester  
SK1 2AE  
Tel: 0330 236 8630  
orders@toshiba-ac.com

**Plymouth**  
Toshiba Air Conditioning  
Porsham Close  
Belliver Industrial Estate  
Plymouth  
Devon  
PL6 7DB  
Tel: 0330 236 8630  
sales.support@toshiba-ac.com