

TOSHIBA

AIR CONDITIONER (MULTI-SPLIT TYPE)

Installation Manual

R32

INVERTER

Outdoor Unit

Model name: _____

RAS-3M26G3AVG-E

RAS-4M27G3AVG-E

RAS-5M34G3AVG-E

* NOTE:

Descriptions about operations for the E unit in this manual are not applicable to RAS-4M27G3AVG-E.

Descriptions about operations for the D unit and the E unit in this manual are not applicable to RAS-3M26G3AVG-E.

Contents

1. Precautions for safety	2
2. Installation / service tools	9
3. Specifications	9
4. Optional parts, accessories	9
5. Installation of outdoor unit	10
6. Refrigerant piping	11
7. Electrical work	14
8. Grounding	15
9. Test run	15
10. Appendix	17

Please read this Installation Manual carefully before installing the Air Conditioner.

- This Manual describes the installation method of the outdoor unit.
- For installation of the indoor unit, refer to the Installation Manual attached to the indoor unit.

IMPORTANT NOTICE

For details on how to install the indoor units, refer to the installation manual accompanying the indoor units.

1 Precautions for safety

The manufacturer shall not assume any liability for the damage caused by not observing the description of this manual.

Be sure to read this installation manual carefully before installing.





The supplied CD-ROM contains the installation manual translated into many languages.

Recommend to the owner to perform maintenance periodically when using over long periods of time.

This appliance can be used by children aged from 8 years and above and persons with reduced physical, sensory or mental capabilities or lack of experience and knowledge if they have been given supervision or instruction concerning use of the appliance in a safe way and understand the hazards involved.



Children shall not play with the appliance. Cleaning and user maintenance shall not be made by children without supervision.

■ Warning indications on the air conditioner unit

	WARNING (Risk of fire)	This mark is for R32 refrigerant only. Refrigerant type is written on nameplate of outdoor unit. In case that refrigerant type is R32, this unit uses a flammable refrigerant. If refrigerant leaks and comes in contact with fire or heating part, it will create harmful gas and there is risk of fire.
	Read the OWNER'S MANUAL carefully before operation.	
	Service personnel are required to carefully read the OWNER'S MANUAL and INSTALLATION MANUAL before operation.	
	Further information is available in the OWNER'S MANUAL, INSTALLATION MANUAL, and the like.	

Warning indication	Description		
 <table border="1" data-bbox="258 1350 507 1514"> <tr> <td data-bbox="264 1359 501 1391">CAUTION</td> </tr> <tr> <td data-bbox="264 1413 501 1505">BURST HAZARD Open the service valves before the operation, otherwise there might be the burst.</td> </tr> </table>	CAUTION	BURST HAZARD Open the service valves before the operation, otherwise there might be the burst.	CAUTION BURST HAZARD Open the service valves before the operation, otherwise there might be the burst.
CAUTION			
BURST HAZARD Open the service valves before the operation, otherwise there might be the burst.			

Be sure to follow the precautions provided here to avoid safety risks. The symbols and their meanings are shown below.

 DANGER	It indicates that incorrect use of this unit can result in a high possibility of severe injury(*1) or death.
 WARNING	It indicates that incorrect use of this unit may cause severe injury or death.
 CAUTION	It indicates that incorrect use of this unit may cause personal injury(*2), or property damage(*3).

*1: A severe injury refers to blindness, injury, burns (hot or cold), electrical shock, bone fracture, or poisoning that leaves after effects and requires hospitalization or extended out-patient treatment.

*2: Personal injury means a slight accident, burn, or electrical shock which does not require admission or repeated hospital treatment.

*3: Property damage means greater damage which affects assets or resources.

For general public use

Power supply cord of parts of appliance for outdoor use shall be at least polychloroprene sheathed flexible cord (design H07RN-F) or cord designation 60245 IEC66 (2.5 mm² or more). (Shall be installed in accordance with national wiring regulations.)

This appliance is not intended for use by person (including children) with reduced physical, sensory or mental capabilities, or lack of experience and knowledge, unless they have been given supervision or instruction concerning use of the appliance by a person responsible for their safety.

Children should be supervised to ensure that they do not play with the appliance.

⚠ CAUTION

To disconnect the appliance from the main power supply

This appliance must be connected to the main power supply by means of a circuit breaker or a switch with a contact separation of at least 3 mm in all poles.

⚠ CAUTION

NEW REFRIGERANT AIR CONDITIONER INSTALLATION

THIS AIR CONDITIONER USES THE NEW HFC REFRIGERANT (R32), WHICH DOES NOT DESTROY THE OZONE LAYER.

R32 REFRIGERANT IS APT TO BE AFFECTED BY IMPURITIES SUCH AS WATER, OXIDIZING MEMBRANES, AND OILS BECAUSE THE PRESSURE OF R32 REFRIGERANT IS APPROX. 1.6 TIMES OF REFRIGERANT R22. AS WELL AS THE ADOPTION OF THIS NEW REFRIGERANT, REFRIGERATING MACHINE OIL HAS ALSO BEEN CHANGED. THEREFORE, DURING INSTALLATION WORK, BE SURE THAT WATER, DUST, FORMER REFRIGERANT, OR REFRIGERATING MACHINE OIL DOES NOT ENTER THE REFRIGERATION CYCLE OF A NEW-REFRIGERANT AIR CONDITIONER. TO AVOID MIXING REFRIGERANT AND REFRIGERATING MACHINE OIL, THE SIZES OF CHARGING PORT CONNECTING SECTIONS ON THE MAIN UNIT ARE DIFFERENT FROM THOSE FOR THE CONVENTIONAL REFRIGERANT, AND DIFFERENT SIZE TOOLS ARE ALSO REQUIRED. FOR CONNECTING PIPES, USE NEW AND CLEAN PIPING MATERIALS WITH HIGH PRESSURE WITHSTAND CAPABILITIES, DESIGNED FOR R32 ONLY, AND ENSURE THAT WATER OR DUST DOES NOT ENTER. MOREOVER, DO NOT USE ANY EXISTING PIPING AS ITS PRESSURE WITHSTAND MAY BE INSUFFICIENT AND MAY CONTAIN IMPURITIES.

 **DANGER**

- THE MANUFACTURER SHALL NOT ASSUME ANY LIABILITY FOR THE DAMAGE CAUSED BY NOT OBSERVING THE DESCRIPTION OF THIS MANUAL.
- FOR USE BY QUALIFIED PERSONS ONLY.
- MEANS FOR DISCONNECTION FROM THE SUPPLY HAVING A CONTACT SEPARATION OF AT LEAST 3 MM IN ALL POLES MUST BE INCORPORATED IN THE FIXED WIRING.
- TURN OFF MAIN POWER SUPPLY BEFORE ATTEMPTING ANY ELECTRICAL WORK. MAKE SURE ALL POWER SWITCHES ARE OFF. FAILURE TO DO SO MAY CAUSE ELECTRIC SHOCK.
- CONNECT THE CONNECTING CABLES CORRECTLY. IF THE CONNECTING CABLES ARE CONNECTED WRONGLY, ELECTRIC PARTS MAY BE DAMAGED.
- CHECK THE EARTH WIRE THAT IT IS NOT BROKEN OR DISCONNECTED BEFORE INSTALLATION.
- DO NOT INSTALL NEAR CONCENTRATIONS OF COMBUSTIBLE GAS OR GAS VAPORS. FAILURE TO FOLLOW THIS INSTRUCTION CAN RESULT IN FIRE OR EXPLOSION.
- TO PREVENT OVERHEATING THE INDOOR UNIT AND CAUSING A FIRE HAZARD, PLACE THE UNIT WELL AWAY (MORE THAN 2 M) FROM HEAT SOURCES SUCH AS RADIATORS, HEATERS, FURNACE, STOVES, ETC.
- WHEN MOVING THE AIR CONDITIONER FOR INSTALLING IT IN ANOTHER PLACE AGAIN, BE VERY CAREFUL NOT TO GET THE SPECIFIED REFRIGERANT (R32) WITH ANY OTHER GASEOUS BODY INTO THE REFRIGERATION CYCLE. IF AIR OR ANY OTHER GAS IS MIXED IN THE REFRIGERANT, THE GAS PRESSURE IN THE REFRIGERATION CYCLE BECOMES ABNORMALLY HIGH AND IT RESULTANTLY CAUSES BURST OF THE PIPE AND INJURIES ON PERSONS.
- IN THE EVENT THAT THE REFRIGERANT GAS LEAKS OUT OF THE PIPE DURING THE INSTALLATION WORK, IMMEDIATELY LET FRESH AIR INTO THE ROOM. IF THE REFRIGERANT GAS IS HEATED BY FIRE OR SOMETHING ELSE, IT CAUSES GENERATION OF POISONOUS GAS.
- WHEN INSTALLING OR RE-INSTALLING THE AIR CONDITIONER, DO NOT INJECT AIR OR OTHER SUBSTANCES BESIDES THE DESIGNATED REFRIGERANT "R32" INTO THE REFRIGERATING CYCLE.
IF AIR OR OTHER SUBSTANCES ARE MIXED, AN ABNORMAL PRESSURE CAN OCCUR IN THE REFRIGERATING CYCLE, AND THIS CAN CAUSE AN INJURY DUE TO A PIPE RUPTURE.

 **WARNING****About the refrigerant**

- This product contains fluorinated greenhouse gases.
- Do not vent gases to the atmosphere.
- The appliance shall be stored in a room without continuously operating ignition sources (for example: open flames, an operating gas appliance or an operating electric heater).
- Do not pierce or burn refrigerant cycle parts.
- Do not use means to accelerate the defrosting process or to clean, other than those recommended by the manufacturer.
- Be aware that refrigerants may not contain an odour.
- The refrigerant inside the unit is flammable. If the refrigerant leaks in the room and comes in contact with fire from a burner, a heater, or a cooker, it may result in fire or the formation of a harmful gas.
- Turn off any combustible heating devices, ventilate the room, and contact the dealer from which you purchased the unit.
- Do not use the unit until a service person confirms that the portion from which the refrigerant leaked is repaired.
- When installing, relocating, or servicing the air conditioner, use only the specified refrigerant (R32) to charge the refrigerant lines. Do not mix it with any other refrigerant and do not allow air to remain in the lines.
- Pipe-work shall be protected from physical damage.
- Compliance with national gas regulations shall be observed.
- Do not use any refrigerant different from the one specified for complement or replacement. Otherwise, abnormally high pressure may be generated in the refrigeration cycle, which may result in a failure or explosion of the product or an injury to your body.
- Installation work must be requested from the supplying retail dealership or professional vendors. Self-installation may cause water leakage, electrical shock, or fire as a result of improper installation.
- Specified tools and pipe parts for model R32 are required, and installation work must be done in accordance with the manual. HFC type refrigerant R32 has 1.6 times more pressure than that of conventional refrigerant (R22). Use the specified pipe parts, and ensure correct installation, otherwise damage and/or injury may be caused. At the same time, water leakage, electrical shock, and fire may occur.
- Be sure to install the unit in a place which can sufficiently bear its weight. If the load bearing of the unit is not enough, or installation of the unit is improper, the unit may fall and result in injury.
- Electrical work must be performed by a qualified electrical engineer in accordance with the code governing such installation work, internal wiring regulations, and the manual. A dedicated circuit and the rated voltage must be used. Insufficient power supply or improper installation may cause electrical shock or fire.
- Use a cabletyre cable to connect wires in the indoor/outdoor units. Midway connection, stranded wire, and single-wire connections are not allowed. Improper connection or fixing may cause a fire.
- Wiring between the indoor unit and outdoor units must be well shaped so that the cover can be firmly placed. Improper cover installation may cause increased heat, fire, or electrical shock at the terminal area.

⚠ WARNING

- Be sure to use only approved accessories or the specified parts. Failure to do so may cause the unit to fall, water leakage, fire or electrical shock.
- After the installation work, ensure that there is no leakage of refrigerant gas. If the refrigerant gas leaks out of the pipe into the room and is heated by fire or something else from a fan heater, stove or gas range, it causes generation of poisonous gas.
- Make sure the equipment is properly earthed. Do not connect the earth wire to a gas pipe, water pipe, lightning conductor, or telephone earth wire. Improper earth work may be the cause of electrical shock.
- Do not install the unit where flammable gas may leak. If there is any gas leakage or accumulation around the unit, it can cause a fire.
- Do not select a location for installation where there may be excessive water or humidity, such as a bathroom. Deterioration of insulation may cause electrical shock or fire.
- Installation work must be performed following the instructions in this installation manual. Improper installation may cause water leakage, electrical shock or fire. Check the following items before operating the unit.
 - Be sure that the pipe connection is well placed and there are no leaks.
 - Check that the service valve is open. If the service valve is closed, it may cause overpressure and result in compressor damage. At the same time, if there is a leak in the connection part, it may cause air suction and overpressure, resulting in burst or injury.
- The installation of pipe work shall be kept to a minimum.
- The following must be certainly done during pump down.
 - Do not incorporate air into the refrigeration cycle.
 - Close the 2 service valves. Stop the compressor and remove the refrigerant pipe. If the refrigerant pipe is removed when the compressor is operating and service valves are opened, the refrigerant cycle will inhale unwanted matter such as air and the pressure in the cycle becomes abnormally elevated. It may cause a burst or injury.
- Do not modify the power cable, connect the cable midway, or use a multiple outlet extension cable. Doing so may cause contact failure, insulation failure, or excess current, resulting in fire or electrical shock.
- If you detect any damage, do not install the unit. Contact your supplying dealer immediately.
- Never modify this unit by removing any of the safety guards or bypassing any of the safety interlock switches.
- Do not wash air conditioners with pressure washers. Electric leaks may cause electric shocks or fires.
- Be sure to comply with local regulations/codes when running the wire from the outdoor unit to the indoor unit. (Size of wire and wiring method etc.)
- When installing the air conditioner in a small room, provide appropriate measures to ensure that the concentration of refrigerant leakage occur in the room does not exceed the critical level. It is not dangerous refrigerant; it has not toxicity. However, a concentration above 0.3 kg/m³ as criterion still causes suffocation. The volume of refrigerant charged to the Multi System air conditioner is more than the volume charged to a conventional individual system.

 **WARNING**

- In accordance with IEC60335-2-40 2018 a minimum floor area **MUST** be observed when installing the Multi System air conditioner. Follow the table below to calculate the minimum floor area for installed product.

Refrigerant amount (kg)	Minimum floor area, When combined with indoor product. (m ²)				
	BI-FLOW CONSOLE	BI-FLOW CONSOLE with refrigerant detection sensor RB-T301-E	HIGH-WALL	1-WAY, 4-WAY CASSETTE	DUCT
≤1.84	–	–	–	–	–
1.92	32	7	4	2	2
2.12	39	7	4	3	3
2.32	46	8	5	3	3
2.39	49	8	5	4	4
2.52	54	9	6	4	4
2.72	63	9	7	5	5
2.92	73	10	8	5	5
3.19	87	11	10	6	6

PLEASE CHECK LOCAL REGULATIONS WHICH MAY IMPOSE DIFFERENT, MORE RESTRICTIVE LIMITS ON REFRIGERANT CHARGE LIMITS, ROOM AREAS AND PERMITTED INSTALLATION LOCATION.

- Before operating the air conditioner after having completed the work, check that the electrical parts control box cover of the indoor unit and valve cover of the outdoor unit are closed, and set the circuit breaker to the ON position. You may receive an electric shock etc. if the power is turned on without first conducting these checks.
- Make sure drain hose insulation if cooling operation is used at sub-zero ambient temperature.
- Do not add any other devices without factory advice.

 **WARNING**

- **After installation work, make sure below before operation.**
 - **Connection pipes are connected properly and no leakage.**
 - **Packed valves are fully open.**

Running compressor without open packed valves may cause abnormal high pressure and parts failure.
Leakage at connection piping may suck air and make further high pressure cause burst and injure.
- **During pump down work make sure below process.**
 - **Don't mix air into the refrigerant cycle.**
 - **Stop the compressor before removing piping after packed valves are fully closed.**

Removing piping under the compressor running and packed valves open, air might be sucked and refrigeration cycle pressure becomes abnormally high, and it causes burst or injury on persons.

 **CAUTION**

- Please read this installation manual carefully before installing the unit. It contains further important instructions for proper installation.
- Exposure of unit to water or other moisture before installation could result in electric shock. Do not store it in a wet basement or expose to rain or water.
- After unpacking the unit, examine it carefully for possible damage.
- Do not install in a place that can increase the vibration of the unit. Do not install in a place that can amplify the noise level of the unit or where noise and discharged air might disturb neighbours.
- This appliance must be connected to the main power supply by means of a circuit breaker depending on the place where the unit is installed. Failure to do so may cause electrical shock.
- Follow the instructions in this installation manual to arrange the drain pipe for proper drainage from the unit. Ensure that drained water is discharged. Improper drainage can result in water leakage, causing water damage to furniture.
- Tighten the flare nut with a torque wrench using the prescribed method. Do not apply excess torque. Otherwise, the nut may crack after a long period of usage and it may cause the leakage of refrigerant.
- Wear gloves (heavy gloves such as cotton gloves) for installation work. Failure to do so may cause personal injury when handling parts with sharp edges.
- Do not touch the air intake section or the aluminium fins of the outdoor unit. It may cause injury.
- Do not install the outdoor unit in a place which can be a nest for small animals. Small animals could enter and contact internal electrical parts, causing a failure or fire.
- Request the user to keep the place around the unit tidy and clean.
- Make sure to conduct a test run after the installation work, and explain how to use and maintain the unit to the customer in accordance with the manual. Ask the customer to keep the operation manual along with the installation manual.
- Do not climb onto or place objects on top of the outdoor unit. You may fall or the objects may fall off of the outdoor unit and result in injury.

Requirement of report to the local power supplier

Please make absolutely sure that the installation of this appliance is reported to the local power supplier before installation. If you experience any problems or if the installation is not accepted by the supplier, the service agency will take adequate countermeasures.

■ Important information regarding the refrigerant used

This product contains fluorinated greenhouse gases.

Do not vent gases into the atmosphere.

Refrigerant type: **R32**

GWP⁽¹⁾ value: **675** * (ex. R32 ref. AR4)

⁽¹⁾GWP = global warming potential

The refrigerant quantity is indicated on the unit name plate.

* This value is based on F gas regulation 517/2014

2 Installation / service tools

Changes in the product and components

In air conditioners using R32, in order to prevent any other refrigerant from being accidentally charged, the service port diameter size of the outdoor unit service valve has been changed. (1/2 UNF 20 threads per inch)

- In order to increase the pressure resisting strength of the refrigerant piping, flare processing diameter and opposing flare nuts sizes have been changed. (for copper pipes with nominal dimensions 1/2 and 5/8)

Gauge manifold for R32	Phillips screwdriver	Pipe cutter	Flare tool for R32
Charge hose for R32	Level	Torque wrench	4 mm hexagonal wrench
Vacuum pump for R32	Scale	Wrench (or spanner)	
Gas leakage detector for R32	Utility knife	Reamer	

3 Specifications

		RAS-5M34G3AVG-E	RAS-4M27G3AVG-E	RAS-3M26G3AVG-E
Operating conditions*1	Cooling operation	-10 to 46 °C		
	Dry operation	-10 to 46 °C		
	Heating operation	-20 to 24 °C		
Dimension	Height	890 mm		
	Width	900 mm		
	Depth	320 mm		
Net weight		78 kg	68 kg	67 kg
Refrigerant R32		2.39 kg	2.05 kg	1.90 kg
Power supply		1 ph, 50 Hz, 220-240 V		
Maximum running current		19.0 A	17.5 A	16.1 A
Circuit breaker rating		25 A		
Power cord (H07RN-F or 60245IEC66)		3-core 4.0 mm ² or more		3-core 3.5 mm ² or more
Connecting cable (H07RN-F or 60245IEC66)		4-core 0.75 mm ² or more		
Pipe length	Minimum for 1 unit	3 m		
	Maximum for 1 unit	25 m		
	Maximum for total unit	80 m	70 m	
	Height difference	15 m		
	No additional refrigerant charge	40 m		
Refrigerant adjustment		20 g/m (41 m - 80 m)	20 g/m (41 m - 70 m)	

The specifications for performance of this air conditioner differs depending on the combination of the indoor units which are operated.

The information in this specifications table applies for the combinations with the catalogue.

For operation, read the owner's manual packed with the indoor unit.

Equipment complying with IEC 61000-3-12.

*1 If the air conditioner is used in conditions other than the above, the safety protection functions may be activated.

* Example of indoor unit class: RAS-10PKVSG-E is abbreviated as "10".

	Indoor unit class	Standard connecting pipe diameter	
E	05 or 07 or 10 or 13	6.35, 9.52 mm	All combinations that do not exceed the "Total" number can be installed. More than 2 indoor units must be connected to an outdoor unit. When 2 indoor units are connected to an outdoor unit, note that some combinations of indoor units are not compatible. For the further details, refer to the catalogue. *2 Need the reducer (12.7 to 9.52 mm). *3 Need the expander (9.52 to 12.7 mm). • Locally procured.
D	05 or 07 or 10 or 13	6.35, 9.52 mm	
C	05 or 07 or 10 or 13 or 16 ²	6.35, 9.52 mm	
B	05 ³ or 07 ³ or 10 ³ or 13 ³ or 16 or 18 or 22 or 24	6.35, 12.7 mm	
A	05 ³ or 07 ³ or 10 ³ or 13 ³ or 16 or 18 or 22 or 24	6.35, 12.7 mm	
Total	68 (RAS-5M34G3AVG-E) 54 (RAS-4M27G3AVG-E) 54 (RAS-3M26G3AVG-E)	—	







4 Optional parts, accessories

Optional parts

Parts name	Specifications			Q'ty
	Indoor unit (abbreviation)	Liquid side (O.D.)	Gas side (O.D.)	
Refrigerant piping*4	05, 07, 10, 13	6.35 mm	9.52 mm	1 ea.
	16, 18, 22, 24	6.35 mm	12.7 mm	
	Putty, PVC tapes			

*4 Refrigerant piping covered with insulating material (Polyethylene foam, 6 mm thick) When duct-type or cassette-type unit is to be installed, it shall be covered with thicker insulating material (Polyethylene foam, 10 mm thick)

Accessories

Installation manual	1		Rubber cap (Water-proof)	5		CD-ROM (Installation manual)	1		F-GAS label	1		Drain nipple	1	
Product specification	1													

5 Installation of outdoor unit

■ Installation Location

- A place which can bear the weight of the outdoor unit and does not cause an increase in noise level and vibration.
- A place where the operation noise and air discharge do not disturb neighbours.
- A place which is not exposed to strong wind.
- A place free of combustible gas.
- A place which does not block a passageway.
- A place where the drain water does not cause any problems.
- A place where there are no obstructions near its air intake or air discharge.

Installation in the following places may result in trouble:

- A place with a lot of machine oil.
 - A place with saline-rich atmosphere such as a coastal area.
 - A place with high level of sulfi de gas.
 - A place where high-frequency waves are likely to be generated, such as from audio equipment, welders, or medical equipment.
- Do not install the unit in such places.

⚠ CAUTION

When the outdoor unit is installed in a place where the drain water might cause any problems, Seal the water leakage point tightly using a silicone adhesive or caulking compound.

■ Precautions for Installation

- When the outdoor unit is to be installed in an elevated position, be sure to secure its feet.
 - If the outdoor unit is to be mounted on a wall, make sure the base plate supporting it is sturdy enough.
 - The base plate should be designed and manufactured to maintain its strength over a long period of time, and sufficient consideration should be given to ensure that the outdoor unit will not fall.
 - When the outdoor unit is installed in a place that is always exposed to strong wind such as a coastal area or on a high story of a building, secure the normal fan operation using a duct or a wind shield.
 - Especially in windy areas, install the unit in such a way as to prevent the admission of wind.
 - When the outdoor unit is to be mounted high on a wall, take particular care to ensure that parts do not fall, and that the installer is protected.
 - When doing installation work at ground level, it is usual to make wiring and pipe connections to the indoor units first, and then to make connections to the outdoor units.
- However, if outdoor work is difficult, you can change the procedure. For example, by making adjustments to the wiring and piping lengths on the inside (rather than the outside).
- When using an air conditioner under low outside temperature conditions (Outside temp: -5 °C or lower) In COOL mode, prepare a duct or wind shield so that it is not affected by the wind.

Necessary Space for Installation

If you need to install the outdoor unit in a location where there are some obstructions or a wall, secure sufficient space as shown in the figure below. The cooling/heating effect may be reduced by 10%.

Upper side view (Unit: mm)

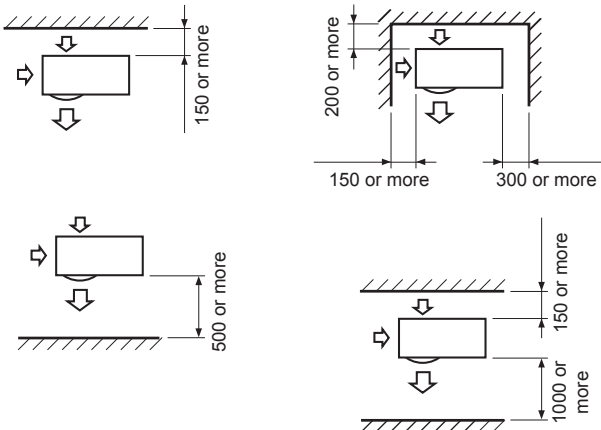

Side view (Unit: mm)

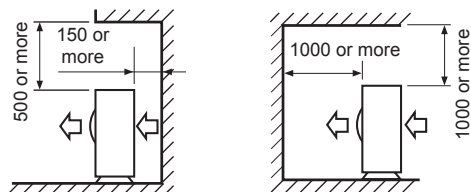

Draining Off the Water from the Outdoor Unit

Install 5 waterproof rubber caps and the drain nipple to drain off the water from the outdoor unit.

- Seal the knock-out holes and screw/thread areas tightly using a silicon adhesive or a caulking compound.
- Use a drain pan to apply a centralized drain.

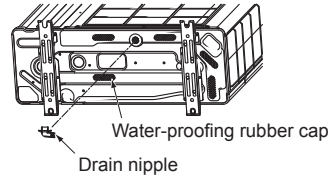

Installation in Regions with Snowfall and Cold Temperatures

Do not use waterproof rubber caps or a drain nipple.

- If you need to install the outdoor unit in a location where there is a possibility of the drain freezing, pay close attention so that the drain does not become frozen.
- To protect the outdoor unit from snow, install the outdoor unit on a holding frame, and attach a snow protection hood and plate.
- Keep the outdoor unit at least 500 mm above the snow accumulation line.

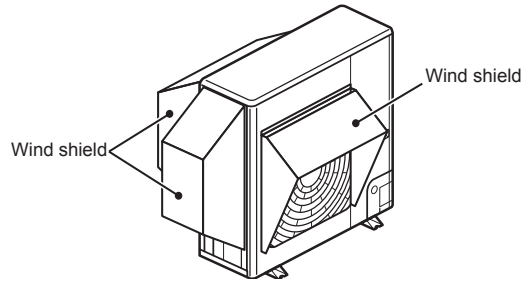

Fixing the Outdoor Unit

Fix the outdoor unit using attachment bolts.

- Use 8 mm or 10 mm anchor bolts and nuts.
- Do not allow the attachment bolts to protrude by more than 15 mm.
- Install the outdoor unit at ground level.
- Attach the vibration-proof rubber pads under the fixing legs.

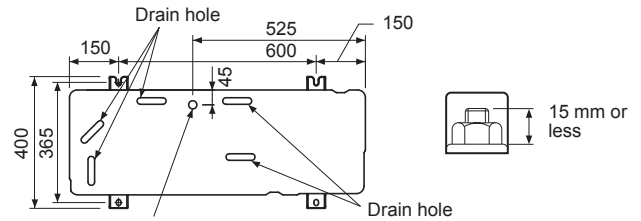

Drain nipple mounting hole

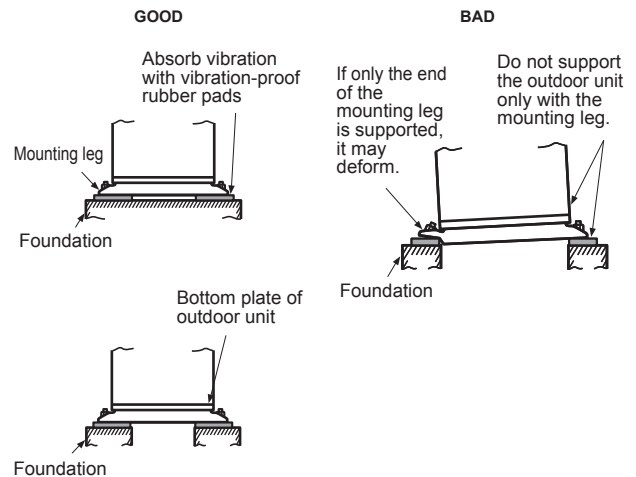

Support the bottom surface of the mounting leg that is in contact with and underneath the bottom plate of the outdoor unit.

6 Refrigerant piping

⚠ CAUTION

Install in rooms that are 13 m³ or larger. If a leak of refrigerant gas occurs inside the room, an oxygen deficiency may occur.

■ Detaching the Front Panel

Remove the 5 screws.

- Pull out the front panel according to the direction of the arrows on the illustration below.

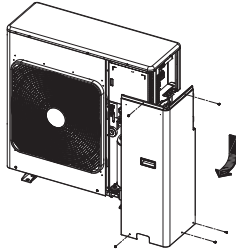

■ Refrigerant Piping Connection

Flaring

1. Cut the pipe with a pipe cutter.



2. Remove the burr inside of the pipe.
When removing the burr, be careful so that chips do not fall into the pipe.
3. Remove the flare nuts attached to the outdoor/indoor unit, then insert them into each of the pipes.
4. Flare the pipes.
See the following table for the projection margin (A) and flaring size (B).

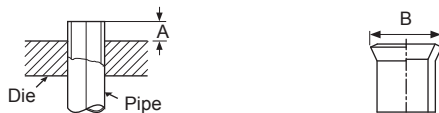

Pipe		A		B	Flare Nut		
Outside diameter	Thickness	Rigid (clutch type) R32 tool	Imperial (wing nut type) R32 tool		Width across flat	Tighten torque	
mm	mm	mm	mm	mm	mm	N·m	kgf·m
6.35	0.8	0 to 0.5	1.5 to 2.0	9.1	17	14 to 18	1.4 to 1.8
9.52	0.8	0 to 0.5	1.5 to 2.0	13.2	22	33 to 42	3.3 to 4.2
12.7	0.8	0 to 0.5	2.0 to 2.5	16.6	26	50 to 62	5.0 to 6.2

⚠ CAUTION

- Do not scratch the inner surface of the flared part when removing burrs.
- Flare processing under the condition of scratches on the inner surface of flare processing part will cause refrigerant gas leak.

Pipe connection

1. Make wire and pipe connections for each indoor unit separately.
2. Align the centres of the connecting pipes and tighten the flare nut as much as possible with your fingers, then tighten the nut using a torque wrench. Be sure to tighten the nut at the specified torque value.
 - If you use one outdoor unit for several indoor units of a different class, connect the largest one first A, then connect the rest in the order B to E.
 - Do not remove the flare nuts for any ports you are not going to use for connection.
 - Do not leave the flare nut unattached for a long period of time.
 - Use a different-diameter joint if the diameters of the connection port and connection piping are different.
 - Mount the different-diameter joint on the connection port of the outdoor unit.

⚠ CAUTION

• KEEP IMPORTANT 7 POINTS FOR PIPING WORK.

- (1) Take away dust and moisture (inside of the connecting pipes).
- (2) Tighten the connections (between pipes and unit).
- (3) Evacuate the air in the connecting pipes using a VACUUM PUMP.
- (4) Check gas leak (connected points).
- (5) Be sure to fully open the packed valves before operation.
- (6) Reusable mechanical connectors and flared joints are not allowed indoors. When mechanical connectors are reused indoors, sealing parts shall be renewed. When flared joints are reused indoors, the flare part shall be refabricated.
- (7) Don't operate air conditioner in case no refrigerant in the system.

■ Air Purge

From the sake of environmental protection, use a vacuum pump to extract the air during installation.

* Prepare a 4 mm hexagon wrench.

1. Connect a charge hose.
 - Make sure that the Handle Hi of the gauge manifold valve is closed fully.
 - Connect the port of the gauge manifold valve and the service port (Valve core (Setting Pin)) using the charge hose.

NOTE

If a control valve or charge valve is attached to the charge hose, leak of R32 refrigerant can be avoided.

2. Open the Handle Low of the gauge manifold valve fully, then operate the vacuum pump.
 - Loosen the flare nut of the at the gas end a little to make sure that air is taken in, then tighten the nut.
 - If you find air is not taken in, make sure that the charge hose is connected to the port(s) securely.
 - Perform extraction for about 40 minutes and make sure that the compound pressure gauge reading is -101 kPa (-76 cmHg).
 - If the compound pressure gauge reading is not -101 kPa (-76 cmHg), there is a possibility air is being taken in from the port(s).
 - Make sure that the charge hose is connected to the port(s) securely.
3. Close the Handle Low of the gauge manifold valve fully, then stop operating the vacuum pump.
 - Leave the gauge and pump as they are for 1 or 2 minutes, then make sure that the compound pressure gauge reading stays at -101 kPa (-76 cmHg).
 - You need not add refrigerant if the piping length is 40 m or less. If the length exceeds 41 m, add 20 g of refrigerant per 1meter over.
4. Disconnect the charge hose from the service port, then open the valve stem fully using a 4 mm hexagon wrench.

Hexagon wrench is required.

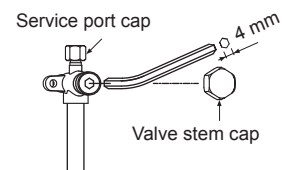

5. Tighten the service valve stem cap and service port cap securely.

CAUTION

Use a torque wrench and tighten the nut at the specified torque value.

6. Tighten all the caps on the valves securely, then perform a gas leak inspection.

- The cap with the 9.52 mm outer diameter is available in two sizes in accordance with the type of packed valve for which the cap is used. The tightening torque depends on the width across flats of the cap so check it in the table below.

Service valve		Tighten torque			
		Valve stem cap		Service port cap	
mm		N•m	kgf•m	N•m	kgf•m
Liquid side (9.52)	H19 mm	16 to 18	1.6 to 1.8	-	-
	H22 mm	33 to 42	3.3 to 4.2		
Gas side (12.7)		33 to 42	3.3 to 4.2	14 to 18	1.4 to 1.8

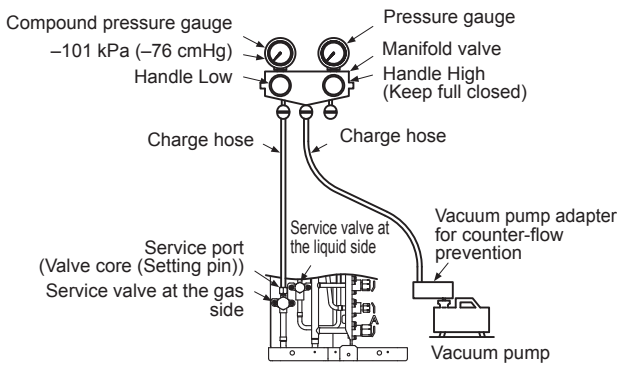

Charging Refrigerant

- You need not add refrigerant if the piping length is 40 m or less.
- If the length exceeds 41 m, add 20 g of refrigerant per 1 meter over.

Procedure to Charge Refrigerant

After extraction is complete, close the valves, then charge the refrigerant.

- Make sure that no operations are in progress while charging the refrigerant.
- If you cannot charge the refrigerant fully, add it from the service port of the service valve at the gas end while cooling operation is in progress.

NOTE

- Charge the refrigerant in a liquid state.
- If you charge the refrigerant in a gas state, the air conditioner will not operate properly since the refrigerant undergoes a change in its composition.

Precautions for Adding Refrigerant

- Use a scale with a precision of at least 10 g per index line when adding the refrigerant. Do not use bathroom scales or similar instruments.
- Use liquid refrigerant when refilling. Since the refrigerant is in liquid form, it can fill up quickly. Therefore add the refrigerant gradually.

Insulation of the Refrigerant Pipes

- Insulate the refrigerant pipes for liquid and gas separately.

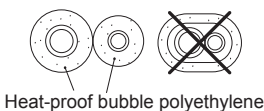

Underground piping: 10t
(Laying the pipes on the wall, ceiling, or under the floor)

Gas Leak Inspection

- Perform a gas leak inspection for the flare nut connections, valve stem connection, and service port cap without fail.
- Use a leak detector exclusively manufactured for R32.

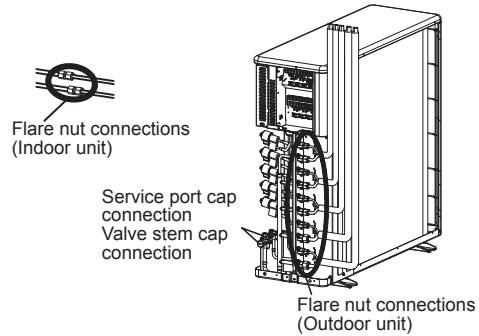

* Check point example (RAS-5M34G3AVG-E)

Performing Additional Installation of an Indoor Unit

- Collect refrigerant from the outdoor unit.
- Turn off the circuit breaker.
- Perform additional installation referring to the procedure from "Refrigerant Piping Connection" on the previous page.

Pump-down Operation (Recovering refrigerant)

CAUTION

Since the forcible running for collecting refrigerant stops automatically after 10 minutes, finish collecting refrigerant within 10 minutes.



Electric current is applied on the control board. Beware of electric shock.

- The following must be certainly done during pump down.
 - Do not incorporate air into the refrigeration cycle.
 - Close the 2 service valves. Stop the compressor and remove the refrigerant pipe. If the refrigerant pipe is removed when the compressor is operating and service valves are opened, the refrigerant cycle will inhale unwanted matter such as air and the pressure in the cycle becomes abnormally elevated. It may cause a burst or injury.

1. Detach the front panel. Do not remove the air discharge grille.
2. Turn on the circuit breaker to supply electricity.
In the initial LED display status, D805 is lighted as below.

○ : ON, ● : OFF, ⊙ : Rapid Flashing (5 times/sec.),
◇ : Slow Flashing (1 time/sec.)

D800	D801	D802	D803	D804	D805
●	●	●	●	●	○

Start running all the indoor units connected to the outdoor unit in the cooling mode.
The checking procedure cannot be completed if the cooling mode is not operated in every indoor units.

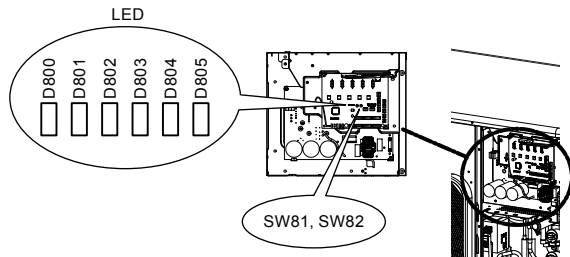

3. Hold down SW81 for at least 5 seconds, and check that D800 is lighted and D804 light is flashing(1time/sec.).

D800	D801	D802	D803	D804	D805
○	●	●	●	◇	●

4. Press SW81 for 1 time. Then D804 light is flashing (5 times/sec.).

D800	D801	D802	D803	D804	D805
○	●	●	●	⊙	●

5. Press SW82 for 1 time. Then D805 light is flashing (5 times/sec.).

D800	D801	D802	D803	D804	D805
○	●	●	●	⊙	⊙

6. Hold down SW82 for at least 5 seconds. Then outdoor unit start cooling mode.
(The display is kept during the refrigerants collection operation.)

D800	D801	D802	D803	D804	D805
○	●	●	●	◇	○

7. Close the valve stem of the service valve at the liquid end.
8. Make sure that the compound pressure gauge reading is -101 kPa (-76 cmHg)
9. Close the valve stem of the service valve at the gas end.
10. The refrigerants collection operation is finished in maximum 10 minutes.
After the collection is finished, promptly stop the operation of all the indoor unit.
(There are cases that the compressor restarts.)
11. When you want to start over the operation of the SW81 and SW82, press the SW81 and SW82 at the same time for 5 sec. (It back to the initial condition of 3.)
However, do not execute the operation during the refrigerants collection.
If by any chance the collection is stopped by the operation, start over the refrigerants collection operation.

7 Electrical work

WARNING

- Be sure to comply with local regulations/ codes when running the wire from the outdoor unit to the indoor unit. (Size of wire and wiring method etc.)
- A lack of electrical capacitance or incorrect wiring may cause an electric shock or a fire.
- To make sure that the wiring connection are secure, use designated cables.
- Fix the cables securely so that no external force applied to the cables may effect the terminals.
- If wiring connections are incomplete or cables are not fixed securely, it may cause a fire.
- Be sure to ground the outdoor unit.
- Incomplete grounding may lead to an electric shock.

CAUTION

- Use a circuit breaker of a type that is not tripped by shock waves.
- Incorrect/incomplete wiring will cause electrical fires or smoke.
- Prepare the power source for exclusive use with the air conditioner.
- This product can be connected to the main power.

Fixed wire connections:

A switch that disconnects all poles and has a contact separation of at least 3 mm must be incorporated into the fixed wiring.

■ Wire Connection

- The dash lines show on-site wiring.

For indoor unit RAS-M series.

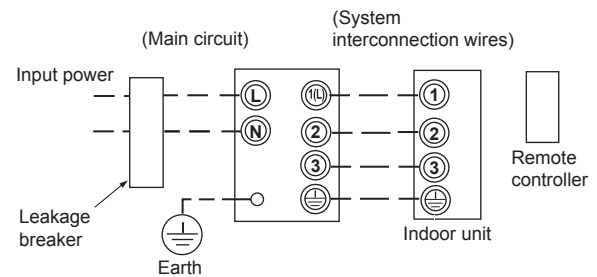

For indoor unit RAS-B series.

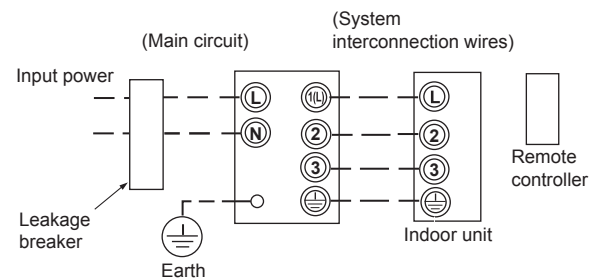

- Connect the indoor/outdoor connecting cables to the identical terminal numbers on the terminal block of each unit.
 - Incorrect connection may cause a failure.
1. Detach the front panel from the outdoor unit.
 2. Remove the cord clamp.
 3. Connect the wires for the power source and each indoor unit.
 - Connect the connecting cable to the terminal as identified by the matching numbers on the terminal block of the indoor and the outdoor unit.
 4. Fix the wiring connections for the power source and each indoor unit securely using a cord clamp.
 5. Attach the front panel to the outdoor unit.

Stripping Length of connecting cable for outdoor unit

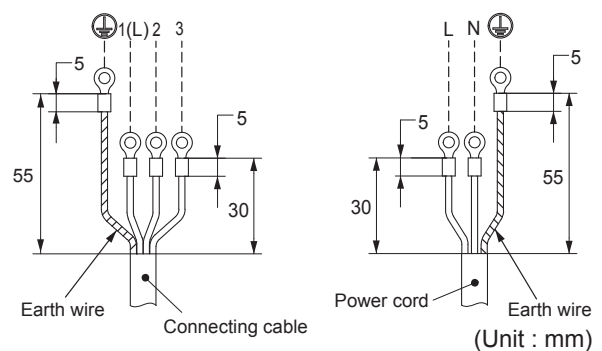

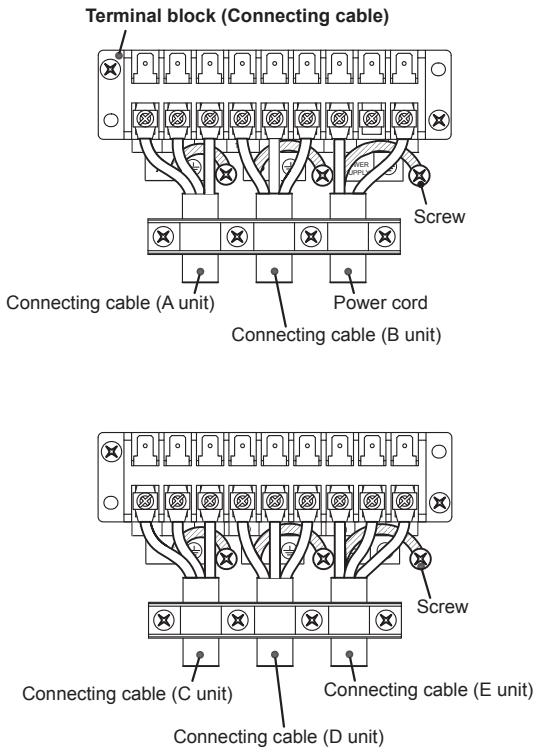

* Connection example (RAS-5M34G3AVG-E)

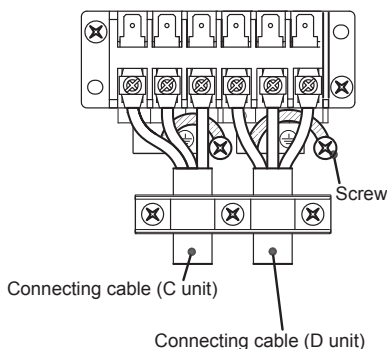

* Connection example (RAS-4M27G3AVG-E)

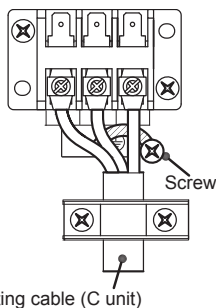

* Connection example (RAS-3M26G3AVG-E)

8 Grounding

This air conditioner must be grounded without fail.

- Grounding is necessary not only to safeguard against the possibility of receiving an electric shock but also to absorb both static, which is generated by high frequencies and held in the surface of the outdoor unit, and noise since the air conditioner incorporates a frequency conversion device (called an inverter) in the outdoor unit.
- If the air conditioner is not grounded, users may receive an electric shock if they touch the surface of the outdoor unit and that unit is charged with static.

9 Test run

■ Wiring/Piping Check

⚠ CAUTION



Electric current is applied on the control board. Beware of electric shock.

1. Detach the front panel of the outdoor unit.
Do not remove the air discharge grille.

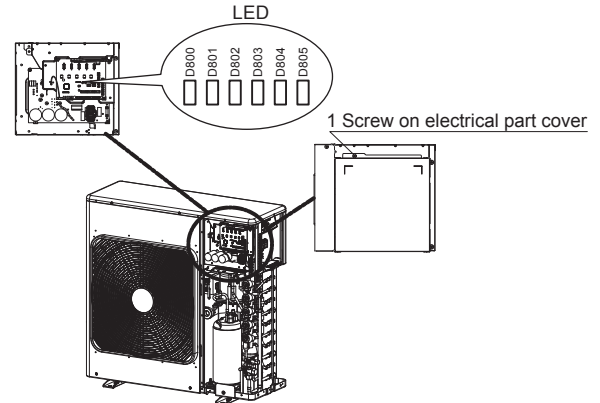

2. Turn on the circuit breaker to supply electricity.
In the initial LED display status, D805 is lighted as below.

○ : ON, ● : OFF, ⊙ : Rapid Flashing (5 times/sec.),
◇ : Slow Flashing (1 time/sec.)

D800	D801	D802	D803	D804	D805
●	●	●	●	●	○

Start running all the indoor units connected to the outdoor unit in the cooling mode.
(The indoor unit in the room that doesn't operate the cooling mode cannot be checked.)

3. After 5 minutes, hold down SW81 for at least 5 seconds, and check that D800 is lighted and D804 light is flashing (1 time/sec.).

D800	D801	D802	D803	D804	D805
○	●	●	●	◇	●

4. Press the SW81 4 times until the LED is displayed as below.

D800	D801	D802	D803	D804	D805
●	●	○	●	⊙	●

5. Press SW82 for 1 times. Then D805 light is flashing (5 times/sec.).

D800	D801	D802	D803	D804	D805
●	●	○	●	⊙	⊙

6. Hold down SW82 for at least 5 seconds. Then the wiring/piping check starts automatically. (The LED display is lighted for a moment.)

D800	D801	D802	D803	D804	D805
●	●	○	●	◇	○

- If no problems are detected, the checking operation returns to the normal operation automatically. The LED is displayed as below.

D800	D801	D802	D803	D804	D805
●	●	●	●	●	○

7. The below is displayed when the error is detected.
(* Repetition of 3 sec ON / 0.5 sec OFF)

D800	D801	D802	D803	D804	D805
○*	○*	○*	○*	○*	○

Press the SW81 3 times until the LED is displayed as below, to check the room judged as error.

D800	D801	D802	D803	D804	D805
●	○	●	●	●	⊙

Incorrect wiring/piping can be checked by pressing SW82. The LED is displayed as below. Turn off the circuit breaker, then check wiring/piping again.

○ : ON, ● : OFF, ⊙ : Rapid Flashing (5 times/sec.),
◇ : Slow Flashing (1 time/sec.)

	LED						Description
	D800	D801	D802	D803	D804	D805	
Check results	●	●	●	●	●	◇	Normal operation (no error)
	○	●	●	●	●	◇	Trouble in unit A
	●	○	●	●	●	◇	Trouble in unit B
	●	●	○	●	●	◇	Trouble in unit C
	●	●	●	○	●	◇	Trouble in unit D
	●	●	●	●	○	◇	Trouble in unit E
	○	○	●	●	●	◇	Trouble in units A and B
	○	●	○	●	●	◇	Trouble in units A and C
	○	●	●	○	●	◇	Trouble in units A and D
	○	●	●	●	○	◇	Trouble in units A and E
	●	○	○	●	●	◇	Trouble in units B and C
	●	○	●	○	●	◇	Trouble in units B and D
	●	○	●	●	○	◇	Trouble in units B and E
	●	●	○	○	●	◇	Trouble in units C and D
	●	●	○	●	○	◇	Trouble in units C and E
	●	●	●	○	○	◇	Trouble in units D and E
	○	○	○	●	●	◇	Trouble in units A, B and C
	○	○	●	○	●	◇	Trouble in units A, B and D
	○	○	●	●	○	◇	Trouble in units A, B and E
	○	●	○	○	●	◇	Trouble in units A, C and D
	○	●	○	●	○	◇	Trouble in units A, C and E
	○	●	●	○	○	◇	Trouble in units A, D and E
	●	○	○	○	●	◇	Trouble in units B, C and D
	●	○	○	●	○	◇	Trouble in units B, C and E
	●	○	●	○	○	◇	Trouble in units B, D and E
	●	●	○	○	○	◇	Trouble in units C, D and E
	○	○	○	○	●	◇	Trouble in units A, B, C and D
	○	○	○	●	○	◇	Trouble in units A, B, C and E
	○	○	●	○	○	◇	Trouble in units A, B, D and E
	○	●	○	○	○	◇	Trouble in units A, C, D and E
●	○	○	○	○	◇	Trouble in units B, C, D and E	
○	○	○	○	○	◇	"Trouble in all units Service valve stays closed"	

- The D800 LED represents unit A.
- The D801 LED represents unit B.
- The D802 LED represents unit C.
- The D803 LED represents unit D.
- The D804 LED represents unit E.

8. When you want to start over the operation of the SW81 and SW82, press the SW81 and the SW82 at the same time for 5 sec. (The procedure will set back to step 3.) However, do not execute the operation during the check. If by any chance the check is stopped by the operation, start over the check after turning off the power once.

9. Notes

- It sometimes takes about 30 minutes maximum for the check.
- During the check, the compressor and the fan of the outdoor/indoor unit repeat ON/OFF.
- You cannot check wiring/piping when the external temperature is 5°C or less. Also, there is a possibility to misjudge if the indoor temperature becomes too low by cooling operation. In that case, execute the cooling operation for per room and check if the connection is normal.

■ Gas Leak Inspection

Refer to the "■ Gas Leak Inspection" on page 12.

■ Test run

1. If you perform the test run in summer, start running in the cooling mode first to decrease the temperature of the room, then run in the heating mode. (Heating mode: Set the temperature to 30°C.)
 - If you perform the test run in winter, start running in the heating mode first to increase the temperature of the room, then run in the cooling mode. (Cooling mode: Set the temperature to 17°C.)
2. For the test run, be sure to satisfy the following conditions below:
 - Perform the test run for each indoor unit respectively.
 - Perform the test run for about 10 minutes in both the cooling mode and the heating mode.
 - You can perform the test run in the cooling/heating mode by utilizing the thermo sensor of the indoor unit.
Cooling mode: Warm the thermo sensor using an appliance such as a hair dryer.
Heating mode: Put a cold towel on the thermo sensor.

■ Instructions for the Customers

- Explain to the customers the proper operation procedure and let them operate the air conditioner along with the supplied instruction manual.
- When multiple indoor units are connected to the outdoor unit, the cooling mode and the heating mode are not available at the same time. When multiple indoor units are running at the same time, the operation mode of the unit which starts running first is applied to the other units.
- When you start running the indoor unit or change the operation mode, the unit starts running after 3 minutes. This is due to the protection function of the unit, not a malfunction.
- When the external temperature becomes low, the pre-heating of the compressor starts to protect it. Keep the circuit breaker on for use. The electricity consumption during pre-heating is about 100 W. If the circuit breaker is turned off, the indoor unit may not start running for about 11 minutes.
- Electronic expansion valves are used for the outdoor unit. When you turn on the power, the outdoor unit starts clattering every 1 or 2 months. This clattering is not a malfunction, but occurs when the unit is returning to the default setting for optimised control.
- While an indoor unit is running in the heating mode, the outdoor unit supplies refrigerant to the other indoor units which are not running. Therefore, noise may come from the other indoor units or the exterior of them may become warm.

10 Appendix

Work instructions

The existing R22 and R410A piping can be reused for inverter R32 product installations.

WARNING

Confirming the existence of scratches or dents on the existing pipes and confirming the reliability of the pipe strength are conventionally referred to the local site.
If the specified conditions can be cleared, it is possible to update existing R22 and R410A pipes to those for R32 models.

Basic conditions needed to reuse existing pipes

Check and observe the presence of three conditions in the refrigerant piping works.

1. **Dry** (There is no moisture inside of the pipes.)
2. **Clean** (There is no dust inside of the pipes.)
3. **Tight** (There are no refrigerant leaks.)

Restrictions for use of existing pipes

In the following cases, the existing pipes should not be reused as they are. Clean the existing pipes or exchange them with new pipes.

1. When a scratch or dent is heavy, be sure to use new pipes for the refrigerant piping works.
2. When the existing pipe thickness is thinner than the specified "Pipe diameter and thickness," be sure to use new pipes for the refrigerant piping works.
 - The operating pressure of R32 is high (1.6 times that of R22). If there is a scratch or dent on the pipe or a thinner pipe is used, the pressure strength may be inadequate, which may cause the pipe to break in the worst case.

* Pipe diameter and thickness (mm)

Pipe outer diameter	Ø6.4	Ø9.5	Ø12.7
Thickness	R32, R410A	0.8	0.8
	R22		

3. When the outdoor unit was left with the pipes disconnected, or the gas leaked from the pipes and the pipes were not repaired and refilled.
 - There is the possibility of rain water or air, including moisture, entering the pipe.

4. When refrigerant cannot be recovered using a refrigerant recovery unit.
 - There is the possibility that a large quantity of dirty oil or moisture remains inside the pipes.

5. When a commercially available dryer is attached to the existing pipes.
 - There is the possibility that copper green rust has been generated.

6. When the existing air conditioner is removed after refrigerant has been recovered.
 - Check if the oil is judged to be clearly different from normal oil.
 - The refrigerant oil is copper rust green in color. There is the possibility that moisture has mixed with the oil and rust has been generated inside the pipe.
 - There is discolored oil, a large quantity of residue, or a bad smell.
 - A large quantity of shiny metal dust or other wear residue can be seen in the refrigerant oil.

7. When the air conditioner has a history of the compressor failing and being replaced.
 - When discolored oil, a large quantity of residue, shiny metal dust, or other wear residue or mixture of foreign matter is observed, trouble will occur.

8. When temporary installation and removal of the air conditioner are repeated such as when leased etc.

9. If the type of refrigerant oil of the existing air conditioner is other than the following oil (Mineral oil), Suniso, Freol-S, MS (Synthetic oil), alkyl benzene (HAB, Barrel-freeze), ester series, PVE only of other series.
 - The winding-insulation of the compressor may deteriorate.

10. When total pipe length is longer than the maximum length for total unit, specified in clause 3, be sure to use new pipes for the refrigerant piping works.

NOTE

The above descriptions are results have been confirmed by our company and represent our views on our air conditioners, but do not guarantee the use of the existing pipes of air conditioners that have adopted R32 in other companies.

Curing of pipes

When removing and opening the indoor or outdoor unit for a long time, cure the pipes as follows:

- Otherwise rust may be generated when moisture or foreign matter due to condensation enters the pipes.
- The rust cannot be removed by cleaning, and new pipes are necessary.

Placement location	Term	Curing manner
Outdoors	1 month or more	Pinching
Indoors	Less than 1 month	Pinching or tapping
	Every time	

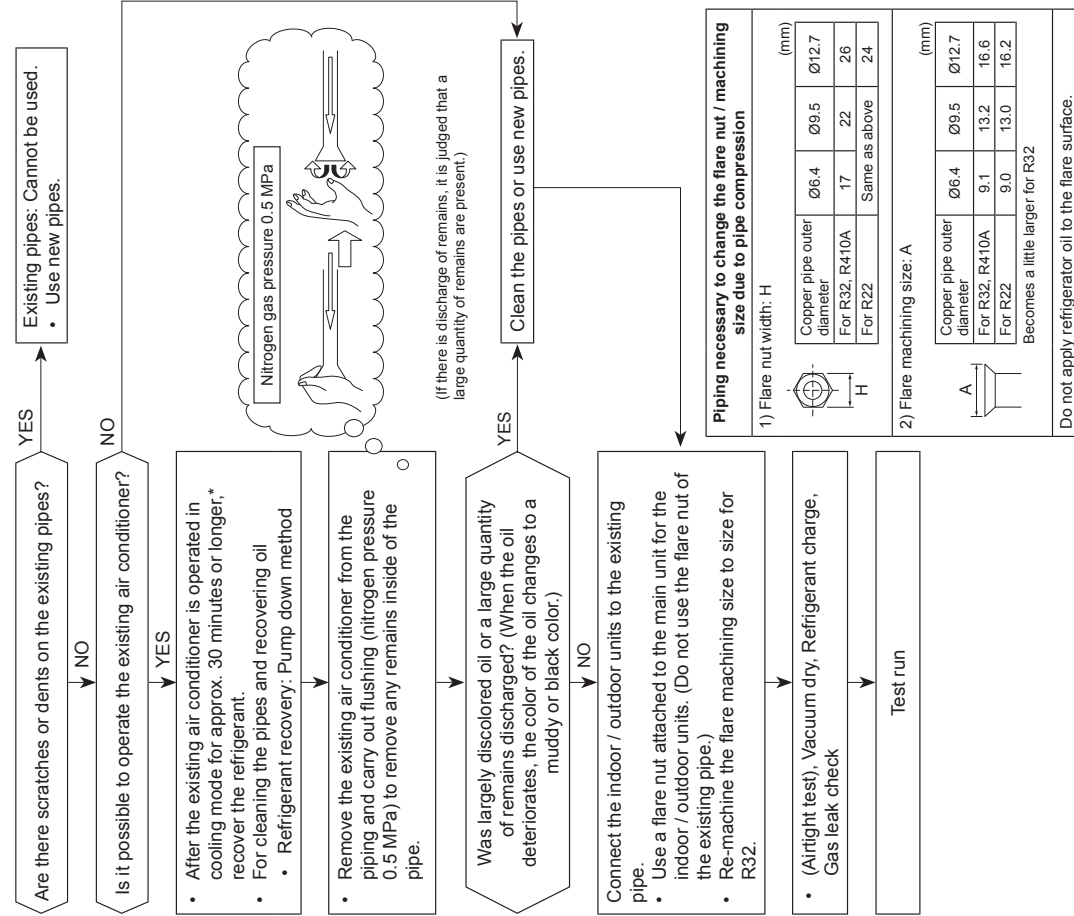

Toshiba Carrier (Thailand) Co., Ltd.

144 / 9 Moo 5, Bangkadi Industrial Park, Tivanon Road, Tambol Bangkadi, Amphur Muang, Pathumthani 12000, Thailand

1116791094