

Toshiba Air Conditioning Data Sheet

SHRM Advance Wall Mounted Haori MMK-UP0121DHPL-E

Features

- Pleasing aesthetic design including luxury style Remote Controller
- Air Purifier Function – Plasma ioniser and ultra-pure Filter
- Left and right louver can be controlled using the Wireless Remote Controller
- Includes 2 decorative Fabrics and is compatible with current Haori fabric options
- R32 Refrigerant
- Suitable for noise sensitive areas utilizing the remote PMV kit for refrigerant control



Outdoor Unit		MMK-UP0121DHPL-E	
Capacity		HP	1.25
Cooling	Nominal Cooling Capacity	kW	3.6
	Power Consumption	kW	0.021
	Running Current	A	0.2
	Starting Current	A	0.25
Heating	Nominal Heating Capacity	kW	4.0
	Power Consumption	kW	0.021
	Running Current	A	0.2
	Starting Current	A	0.25
Air Flow	h/m/l	m3/h	540/410/300
	h/m/l	l/s	150/114/83
Sound	Pressure h-l	dB(A)	37/35/32/28/25
Unit	Height x Width x Depth	mm	300x987x210
	Weight	kg	11
Pipe connections		inch	3/8 - 1/4
Drain Port connection		mm	16
Electrical	Power supply	V/ph/Hz	220/240-1-50
The electrical installation needs to meet current UK electrical regulations BS7671:2018+A2:2022 the 18th Edition of the IET regulations. Fuse sizes shown are for guidance only, cables and protective devices should be calculated using the MCA/MOCP details provided			

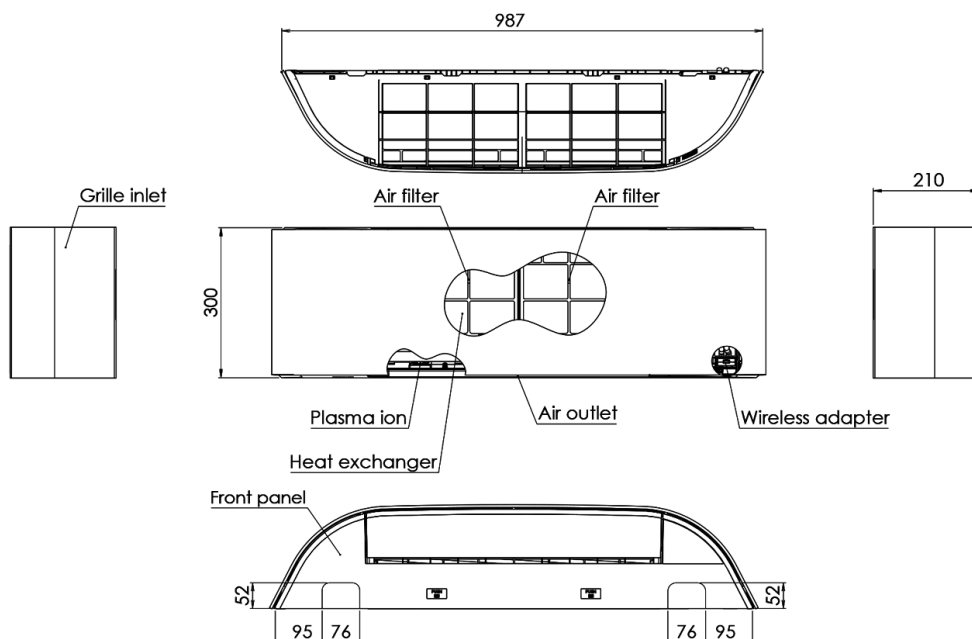

Contact us for full details at
sales@cooldesignsstd.co.uk
 or visit www.cdweb.info



Raising the standards in Air Conditioning Distribution

Gateshead
0191 5496964

Warrington
01925 820000

Glasgow
01355 234776