

10536

05 - 2019

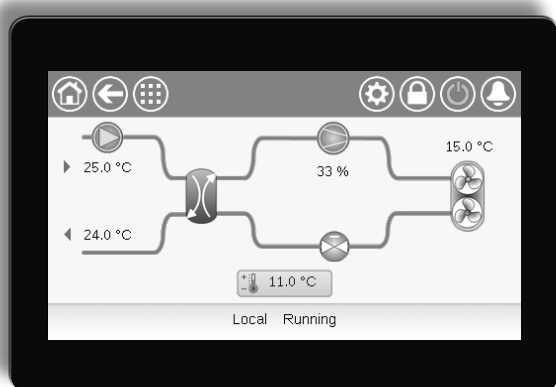

Instruction manual

AQUACIATPOWER (I)LD-ST / -HE (602-2000)

CONNECT TOUCH



CONTENTS

PREFACE	3	8 - STANDARD CONTROL OPERATIONS AND OPTIONS	39
1 - SAFETY CONSIDERATIONS	4	8.1 Unit Start / Stop control.....	39
1.1 Safety guidelines	4	8.2 Heating / Cooling control	39
1.2 Safety precautions	4	8.3 Supplementary heating.....	40
2 - CONTROL OVERVIEW	5	8.4 Water pumps control.....	40
2.1 Control system.....	5	8.5 Hydronic kit option	41
2.2 System functionalities	5	8.6 Control point	42
2.3 Operating modes	5	8.7 Capacity limitation	43
2.4 CONNECT TOUCH control system.....	5	8.8 Controlling capacity	44
3 - CONTROL COMPONENTS	6	8.9 Night mode	44
3.1 CONNECT TOUCH overview	6	8.10 Controlling the coil pressure	44
3.2 Features overview	6	8.11 Setting holidays	45
4 - HARDWARE	7	8.12 Dry cooler – free cooling option	45
4.1 Control boards.....	7	8.13 Energy Management Module	45
4.2 Power supply to boards	7	8.14 Heat recovery option (desuperheater)	45
4.3 Light Emitting Diodes on boards.....	7	8.15 Defrost cycle (heat pumps only)	46
4.4 Pressure transducers.....	7	8.16 Master/Slave control.....	46
4.5 Temperature sensors.....	7	8.17 BACnet IP option	46
4.6 Actuators	8	8.18 Brine options	46
4.7 Terminal block connections	8	8.19 Refrigerant gas leak detection option	46
5 - CONNECT TOUCH USER INTERFACE	10	8.20 Software Activation Key(s).....	47
5.1 Menu structure.....	11	9 - DIAGNOSTICS	48
5.2 Header buttons.....	13	9.1 Control diagnostics.....	48
5.3 Explore the synoptic screen.....	14	9.2 E-mail notifications	48
5.5 Set the schedule.....	15	9.3 Alarms description.....	49
5.6 Manage display settings	16	10 - MAINTENANCE	56
5.7 Monitor unit parameters.....	17		
5.9 Override system configuration	18		
5.10 Analyse history trends	19		
6 - WEB CONNECTION	20		
6.1 Web interface	20		
6.2 Technical documentation.....	20		
7 - CONNECT TOUCH CONTROL: MENU STRUCTURE	21		
7.1 Main menu.....	21		
7.2 Configuration menu (CONFIG)	30		
7.3 Network Parameters menu	34		
7.4 System Menu.....	36		
7.5 Alarm Menu	38		

PREFACE

The goal of this document is to give a broad overview of the main functions of the control system used to control AQUACIAT^{POWER} LD -ST/-HE air-cooled liquid chillers and AQUACIAT^{POWER} ILD -ST/-HE reversible heat pumps with 160 to 520 kW cooling/heating capacity.

Instructions in this manual are given as a guide to good practice in the installation, start-up and operation of the control system. This document does not contain full service procedures for the correct operation of the equipment.

The support of a qualified Manufacturer Service Engineer is strongly recommended to ensure optimal operation of the equipment as well as the optimization of all available functionalities.

Note that this document may refer to optional components and certain functions, options or accessories may not be available for the specific unit.

IMPORTANT: All screenshots of the user interface provided in this manual include text in English. After changing the language of the system, all labels will be in the language selected by the user.

Please read all instructions prior to proceeding with any work. Pay attention to all safety warnings.

The information provided herein is solely for the purpose of allowing customers to operate and service the equipment and it is not to be reproduced, modified or used for any other purpose without the prior consent of the Manufacturer.

Acronyms / Abbreviations

In this manual, the refrigeration circuits are called circuit A and circuit B. Compressors in circuit A are labelled A1, A2, A3, A4, whereas compressors in circuit B are labelled B1, B2, B3, B4.

Acronym	Description
BMS	Building Management System
DGT	Discharge Gas Temperature
EHS	Electric Heater Stage
EMM	Energy Management Module
EWT	Entering Water Temperature
EXV	Electronic Expansion Valve
FC	Free Cooling
DCFC	Dry Cooler Free Cooling
HSM	Hydronic System Manager
LED	Light Emitting Diode
LWT	Leaving Water Temperature
OAT	Outdoor Air Temperature
SCT	Saturated Condensing Temperature
SST	Saturated Suction Temperature
VFD	Variable Frequency Drive

Abbreviation	Description
Local-Off mode / LOFF	Operating type: Local Off
Local-On mode / L-On	Operating type: Local On
Local-Schedule mode / L-SC	Operating type: Local schedule
Master mode / Mast	Operating type: Master
Network mode / Net	Operating type: Network
Remote mode / Rem	Operating type: Remote

1 - SAFETY CONSIDERATIONS

1.1 Safety guidelines

Installation, start-up and servicing of equipment can be hazardous if certain factors particular to the installation are not considered: operating pressures, electrical components, voltages, and the installation site (elevated plinths and built-up structures).

Only qualified installation engineers and fully trained technicians are authorised to install and start up the equipment.

All instructions and recommendations provided in the service guide, installation and operation manuals, as well as on tags and labels fixed to the equipment, components and other accompanying parts supplied separately must be read, understood and followed.

Failure to comply with the instructions provided by the manufacturer may result in injury or product damage.

IMPORTANT: Only qualified service engineers should be allowed to install and service the equipment.

1.2 Safety precautions

Only personnel qualified in accordance with IEC (International Electrotechnical Commission) recommendations may be permitted access to electrical components.

It is particularly recommended that all sources of electricity to the unit should be shut off before any work is begun. Shut off the main power supply at the main circuit breaker or isolator.

IMPORTANT: The equipment uses and emits electromagnetic signals. Tests have shown that the equipment conforms to all applicable codes with respect to electromagnetic compatibility.

CAUTION

RISK OF ELECTROCUTION! Even when the main circuit breaker or isolator is switched off, specific circuits may still be energised as they may be connected to a separate power source.

CAUTION

RISK OF BURNS! Electrical currents may cause components to get hot. Handle the power cable, electrical cables and conduits, terminal box covers and motor frames with great care.

2 - CONTROL OVERVIEW

2.1 Control system

AQUACIAT^{POWER} chillers and heat pumps are equipped with the CONNECT TOUCH control that serves as a user interface and a configuration tool for controlling the chiller / heat pump operation.

AQUACIAT^{POWER} LD-ST chillers and AQUACIAT^{POWER} ILD-ST heat pumps are typically equipped with fixed speed fans, whereas AQUACIAT^{POWER} LD-HE chillers and AQUACIAT^{POWER} ILD-HE heat pumps use variable speed fans which reduce the unit energy use during occupied and unoccupied periods, provide condensing and evaporating pressure control and smooth fan start. The system may also control fixed speed pumps or variable speed pumps with a hydronic module.

IMPORTANT: *The document may refer to optional components and certain functions, options, or accessories may not be available for the specific unit. Heating option applies only to heat pumps and cooling-only units equipped with a boiler.*

2.2 System functionalities

The system controls the start-up of the compressors needed to maintain the desired heat exchanger entering and leaving water temperature. It constantly manages the operation of the fans in order to maintain the correct refrigerant pressure in each circuit and monitors safety devices that protect the unit against failure and guarantee its optimal functioning.

2.3 Operating modes

The control may operate in three independent modes:

- **Local mode:** The unit is controlled by commands from the user interface.
- **Remote mode:** The unit is controlled by dry contacts.
- **Network mode:** The unit is controlled by networks (Proprietary Protocol). Data communication cable is used to connect the unit to the proprietary protocol communication bus.

When the control operates autonomously (Local or Remote), it retains all of its control capabilities but does not offer any features of the Network.

CAUTION

Emergency stop! The Network emergency stop command stops the unit regardless of its active operating type.

2.4 CONNECT TOUCH control system

- Allows users to control the unit via the CONNECT TOUCH user interface.
- Provides web connectivity technology.
- Includes the trending functionality.
- Supports Enhanced Control Management (M2M, Cristo Control, Power Control, Easy/Smart Control) for multiple chillers/heat pump configuration.
- Provides direct BMS integration capabilities (Modbus RTU, Modbus TCP/IP, BACnet/IP option or Lon option).

3 - CONTROL COMPONENTS

3.1 CONNECT TOUCH overview

The CONNECT TOUCH system manages a number of mechanisms allowing the unit to operate effectively, including variable speed fans' control, fixed or variable speed pumps' control, etc.

The CONNECT TOUCH control system is used to control the following types of AQUACIAT^{POWER} range units:

AQUACIAT ^{POWER} LD ST	Standard cooling-only air-cooled chillers
AQUACIAT ^{POWER} LD HE	High efficiency cooling-only air-cooled chillers
AQUACIAT ^{POWER} ILD ST	Standard air-to-water reversible heat pumps
AQUACIAT ^{POWER} ILD HE	High efficiency air-to-water reversible heat pumps

3.2 Features overview

Feature	Cooling-only Chillers		Reversible Heat Pumps	
	LD -ST series	LD -HE series	ILD -ST series	ILD -HE series
BMS connection	●	●	●	●
4.3" touch screen	●	●	●	●
Web connectivity	●	●	●	●
E-mail transmission	●	●	●	●
Occupied / Unoccupied mode management	●	●	●	●
Trending	●	●	●	●
Master/Slave control	●	●	●	●
Diagnostics	●	●	●	●
Cooling control	●	●	●	●
Free cooling (dry cooler mgmt.)	○	○	○	○
Heating control	-	-	●	●
Boiler heating control	○	○	○	○
Electric heating control	-	-	○	○
Partial heat recovery	○	○	○	○
Defrost mechanism	-	-	●	●
Free defrost control	-	-	●	●
Brine fluid	○	○	○	○
Refrigerant leak detection	○	○	○	○
Fixed speed fans	●	-	●	-
Variable speed fans	-	●	-	●
XtraFan	-	○	-	○
Anti-freeze protection	○	○	○	○
Fixed speed pump(s)	○	○	○	○
Variable speed pump(s)	○	○	○	○
Communication				
Proprietary protocol	●	●	●	●
Modbus RTU or TCP/IP	●	●	●	●
BACnet IP	○	○	○	○
LonTalk	○	○	○	○

●	Supplied as standard
○	Option
-	Not available

4 - HARDWARE

4.1 Control boards

The electrical box includes all boards controlling the unit as well as the CONNECT TOUCH user interface.

Each circuit is by default fitted with one SIOB board used to manage all major inputs and outputs of the controller.

Options such as energy management module or free cooling (dry cooler management) require the installation of additional boards, i.e. EMM SIOB board for energy management module and FC dry cooler board for free cooling. Additionally, units with seven or eight fixed speed fans are fitted with an additional auxiliary 2 board "AUX2 board".

All boards communicate via an internal bus.

4.2 Power supply to boards

All boards are supplied from a common 24 VAC supply referred to earth.

CAUTION

Maintain correct polarity (and grounded 0V) when connecting the power supply to the boards, otherwise the boards may be damaged.

In the event of a power supply interrupt, the unit restarts automatically without the need for an external command. However, any faults active when the supply is interrupted are saved and may in certain cases prevent a given circuit or the unit from restarting.

The main board continuously monitors the information received from various pressure and temperature probes and accordingly starts the program that controls the unit.

The number of boards available in the electrical box depends on the number of selected options.

4.3 Light Emitting Diodes on boards

All boards continuously check and indicate the proper operation of their electronic circuits. A light emitting diode (LED) lights on each board when it is operating properly.

- The red LED flashing for a two-second period indicates correct operation. A different rate indicates a board or a software failure.
- The green LED flashes continuously on all boards to show that the board is communicating correctly over its internal bus. If the green LED is not flashing, this indicates the internal bus wiring problem or a configuration issue.

4.4 Pressure transducers

Three types of transducers (high pressure, low pressure, water pressure) are used to measure various pressures in each circuit. These transducers deliver 0 to 5 VDC. They are connected to SIOB boards (circuit A and circuit B).

Discharge pressure transducers (high pressure type)

These transducers measure the discharge pressure in each circuit. They are used to control condensing pressure or high pressure load shedding. Discharge pressure sensors are mounted on the discharge line piping of each circuit.

Suction pressure transducers (low pressure type)

These transducers measure the suction pressure in each circuit. They are used to control EXV, evaporating pressure (in heating mode) and monitor suction pressure safeties related to the compressor operating envelope. Suction pressure sensors are located on the common suction piping of each circuit.

Pump inlet/outlet water pressure transducers (water pressure type, hydronic kit option)

These transducers measure the hydronic kit pump inlet/outlet water pressure and monitor the water flow. Pump inlet/outlet water pressure sensors are mounted on the optional hydronic kit.

4.5 Temperature sensors

Temperature sensors constantly measure the temperature of various components of the unit, ensuring the correct operation of the system.

Water heat exchanger entering and leaving water temperature sensors

The water heat exchanger entering and leaving water temperature sensors are used for capacity control and safety purposes.

Outdoor air temperature sensor

This sensor measuring the outdoor air temperature is used for start-up, setpoint temperature reset and frost control.

Suction gas temperature sensors

These sensors measure the suction gas temperature. They are used for the EXV control. Suction gas temperature sensors are located at the suction side of each circuit.

Master/slave water sensor (optional)

This sensor measures the common water temperature in the master/slave system capacity control. It is installed only in the case of master/slave units.

Defrost temperature sensors (heat pumps)

These sensors are used to determine the end of the defrost cycle for a given circuit.

Temperature setpoint reset sensor (Energy Management Module)

This sensor measures the space (room) temperature for the purpose of setpoint reset.

4 - HARDWARE

4.6 Actuators

Electronic expansion valve

The electronic expansion valve (EXV) is used to adjust the refrigerant flow to changes in the operating conditions of the machine. The high degree of accuracy with which the piston is positioned provides precise control of the refrigerant flow and suction superheat.

Water flow switch

For units without internal pumps, a flow switch is mounted to ensure that the minimum flow rate required for the correct operation and protection of the system is maintained.

The minimum flow rate threshold depends on the unit size and is configured automatically at the start-up. If the flow switch fails, the alarm condition shuts off the unit.

Water heat exchanger pumps (optional)

The controller can regulate one or two fixed speed or variable speed water heat exchanger pumps and takes care of the automatic changeover between these pumps.

Four-way valve (heat pumps)

The control actuates the four-way valve for cooling / heating mode and defrosts' sessions.

4.7 Terminal block connections

Connections available at the user terminal block may vary depending on the selected options. The following table summarizes connections at the user terminal block.

IMPORTANT: Some contacts can be accessed only when the unit operates in Remote mode.

Terminal block connections				
Description	Board	Input/Output	Connector	Remarks
On/Off switch	SIOB, circuit A	DI-01	J1	Used for the unit On/Off control (Remote mode)
Heat/Cool switch	SIOB, circuit A	DI-04	J1	Used to switch between cooling and heating when the unit is in Remote mode (Heat pumps only)
Second setpoint switch	SIOB, circuit A	DI-02	J1	Used to switch between setpoints
Demand limit switch 1	SIOB, circuit A	DI-03	J1	Used to control demand limit
Alarm relay	SIOB, circuit A	DO-05	J23	Indicates alarms
Running relay	SIOB, circuit A	DO-06	J22	Indicates if the unit is ready to start or operating
Desuperheater demand	SIOB, circuit B	DI-04	J1	Heat recovery is allowed
Lock switch	SIOB, circuit B	DI-02	J1	Used for the customer safety loops
Customer pump 1	SIOB, circuit B	DO-05	J23	The control can regulate one or two evaporator pumps and automatically change over between the two pumps
Customer pump 2	SIOB, circuit B	DO-06	J22	The control can regulate one or two evaporator pumps and automatically change over between the two pumps
Optional				
Setpoint reset control	SIOB, circuit A	AI-10	J9	Allows the user to reset the currently selected setpoint
Occupancy override	SIOB, EMM	DI-01	J1	Used to switch between occupied (closed contact) and unoccupied mode (open contact)
Demand limit switch 2	SIOB, EMM	DI-02	J1	Used to control demand limit
Customer interlock	SIOB, EMM	DI-03	J1	Used for the customer safety loops
Ice done contact	SIOB, EMM	DI-04	J1	Used to control the setpoint for ice storage in unoccupied mode
Capacity limit control	SIOB, EMM	AI-10	J9	Used for capacity limitation
Chiller partially shutdown	SIOB, EMM	DO-05	J23	Indicates the shutdown of one of the circuits
Chiller totally shutdown	SIOB, EMM	DO-06	J22	Indicates the unit shutdown
Chiller capacity running output (0 to 10 V)	SIOB, EMM	AO-01	J10	R eports the capacity percentage of the unit
Desuperheater customer pump	SIOB, EMM	DO-01	J2	The control can regulate a customer pump for heat recovery. The connection has to be done between the pin DO-01 of connector J2 and the pin IN-01 of connector J4
		IN-01	J4	

4 - HARDWARE

4.7.1 Volt-free contact (on/off and cooling/heating)

For chillers with a boiler or heat pumps, on/off contacts and cooling/heating contacts are as follows:

	Off	Cooling	Heating	Auto
On/Off contact	open	closed	closed	open
Cooling/heating contact	open	open	closed	closed

Off: Unit is stopped
 Cooling: Unit is allowed to start in Cooling
 Heating: Unit is allowed to start in Heating (chiller with boiler control or heat pump)
 Auto: Unit can run in Cooling or Heating in accordance with the changeover values. If the automatic changeover is enabled (Heat/Cool Select, GENUNIT – General Parameters), the operating mode is selected based on OAT.

4.7.2 Volt-free setpoint selection contact

This dry contact is used to switch between setpoints. It is active only when the control is in Remote mode.

	Cooling			Heating		
	Stp1	Stp2	Auto	Stp1	Stp2	Auto
Setpoint selection contact	open	closed	-	open	closed	-

4.7.3 Volt-free demand limit selection contact

Up to two dry contacts can be used to limit unit capacity. Note that the second contact is available only for units with the energy management module.

Capacity limitation with two contacts is as follows:

	100%	Limit 1	Limit 2	Limit 3
Demand limit 1 contact	open	closed	open	closed
Demand limit 2 contact	open	open	closed	closed

Please note that limit thresholds can be defined via the user interface in the Setpoint menu (see section 7.1).

4.7.4 Ice storage (Energy Management Module)

For units with the optional Energy Management Module, the control includes an additional setpoint (Ice setpoint) used for ice storage control.

	Cooling setpoint		
	CSP1	CSP2	ICE_STP
Occupancy schedule	occupied	unoccupied	unoccupied
Ice done switch	open/closed	closed	open

5 - CONNECT TOUCH USER INTERFACE

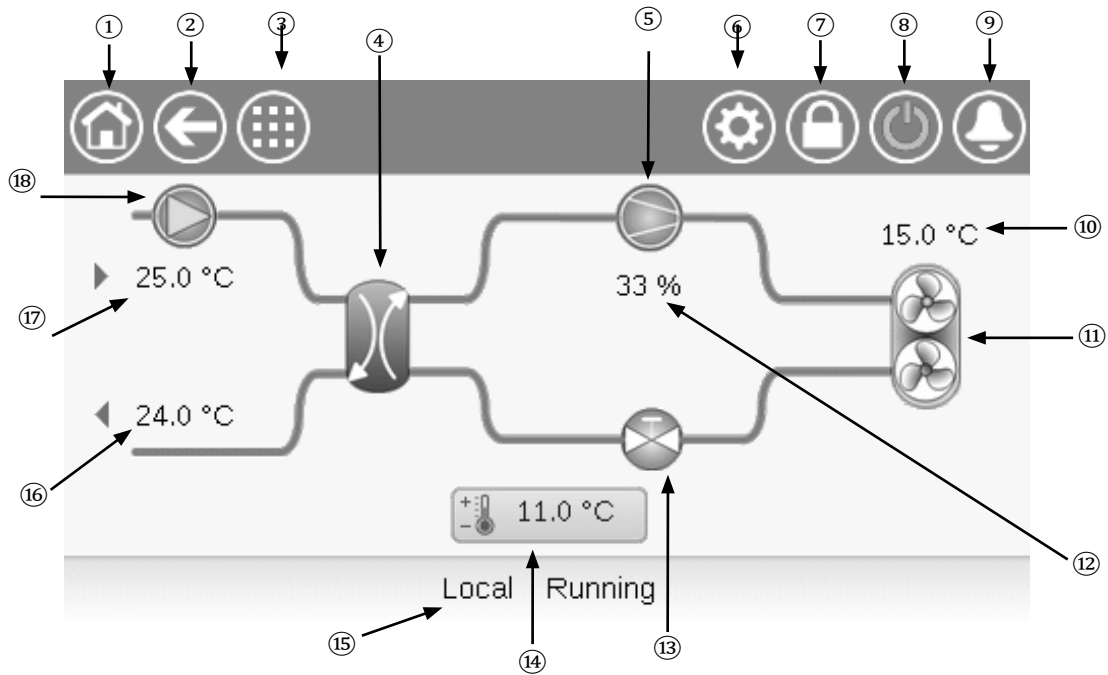

- | | |
|--|------------------------------------|
| ① Home button | ⑩ OAT (Outdoor Air Temperature) |
| ② Back button | ⑪ Condenser fans |
| ③ Main menu button | ⑫ Unit capacity |
| ④ Heat exchanger | ⑬ EXV (Electronic Expansion Valve) |
| ⑤ Compressor | ⑭ Setpoint |
| ⑥ System menu | ⑮ Unit status |
| ⑦ Login button (restricted acces to menus) | ⑯ LWT (Leaving Water Temperature) |
| ⑧ Start/Stop button | ⑰ EWT (Entering Water Temperature) |
| ⑨ Alarm button | ⑱ Water pump (optional) |

Connections

Connections are located on the bottom of the controller.

- The control offers communication protocols such as LEN, Proprietary Protocol, Modbus, or BACnet.
- It is possible to enable and disable end of line resistors via the System menu (see section 7.4).
- One Ethernet ports allow for TCP/IP communication or BMS (Building Management System) connection.

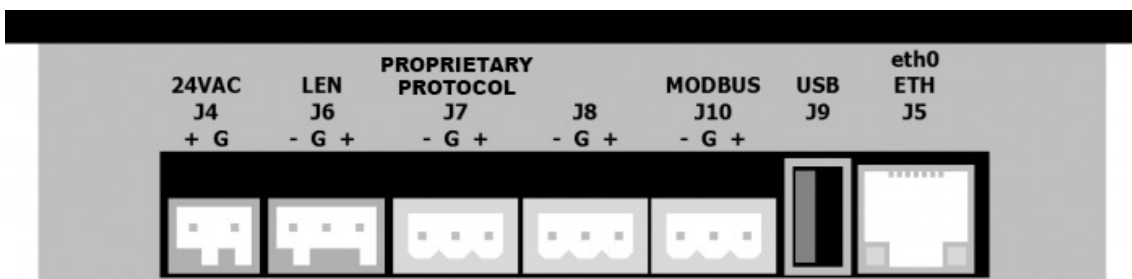

Features of CONNECT TOUCH user interface

- 4.3" colour touch screen with quick display of alarms, current unit operating status, etc.
- Resistive touch screen technology
- Trending capability
- Web connectivity
- Custom language support

CAUTION

If the touch screen is not used for a long period of time, the screen it goes blank. The control is always active and the operating mode remains unchanged. Press anywhere on the screen and the Welcome screen will be displayed.

5 - CONNECT TOUCH USER INTERFACE

5.1 Menu structure

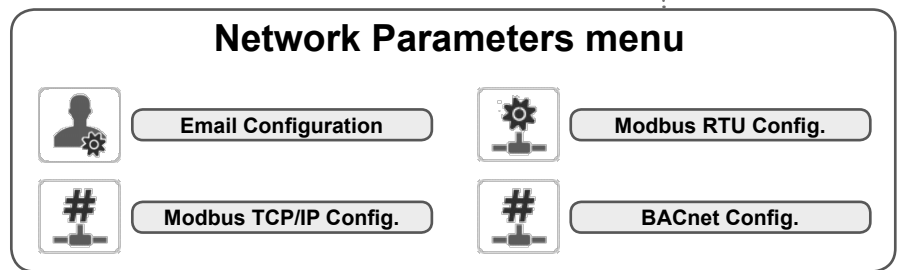
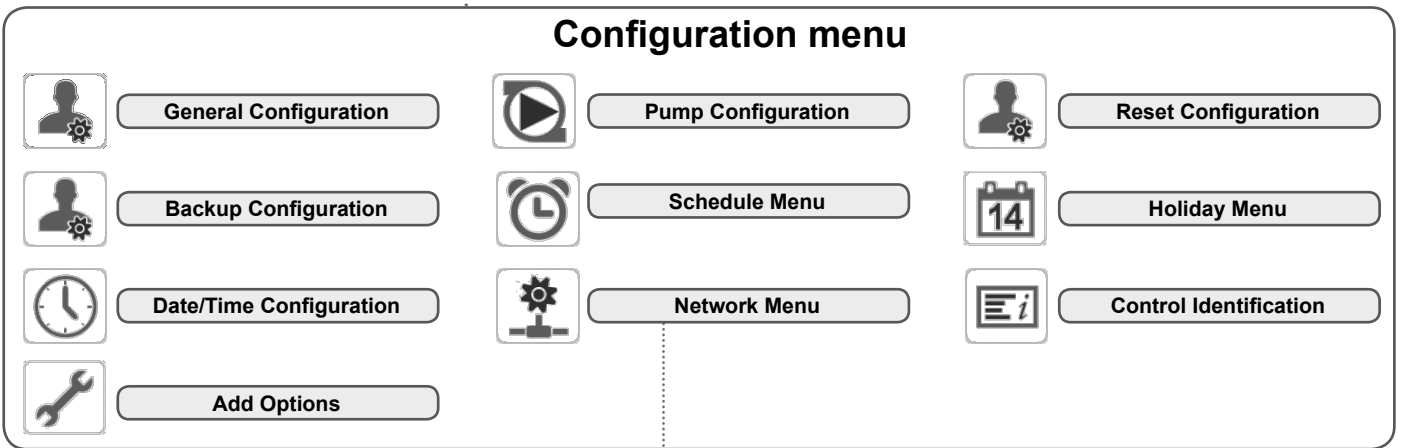
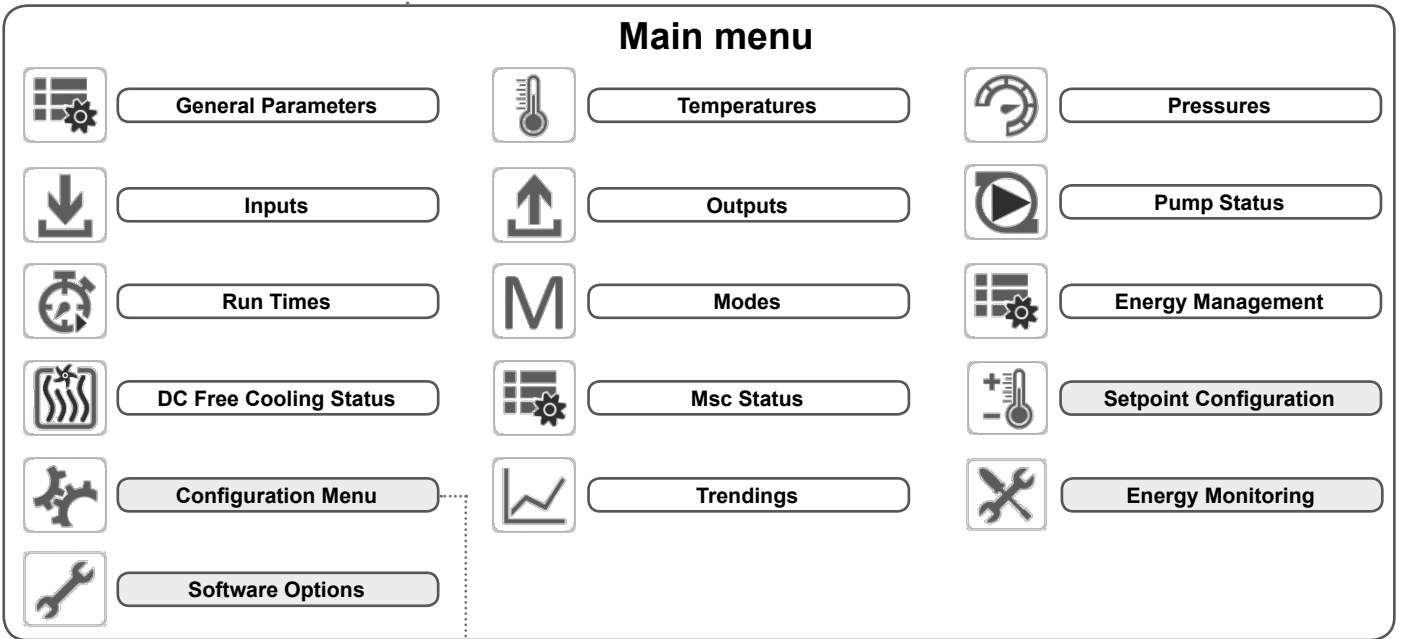
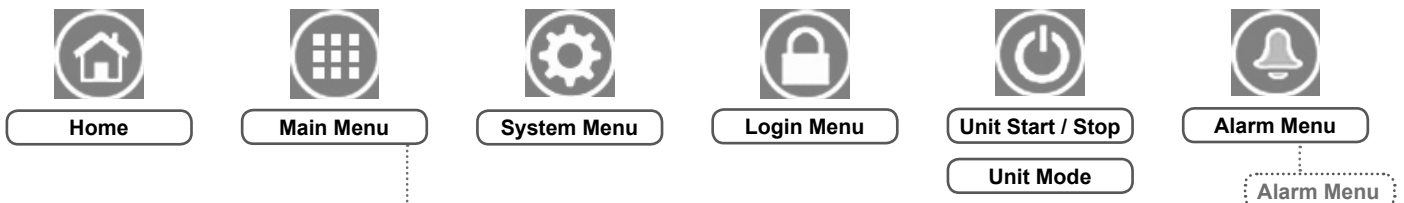

Legend:

No password required
(basic access = 0)

User password required
(default password =11)

5 - CONNECT TOUCH USER INTERFACE

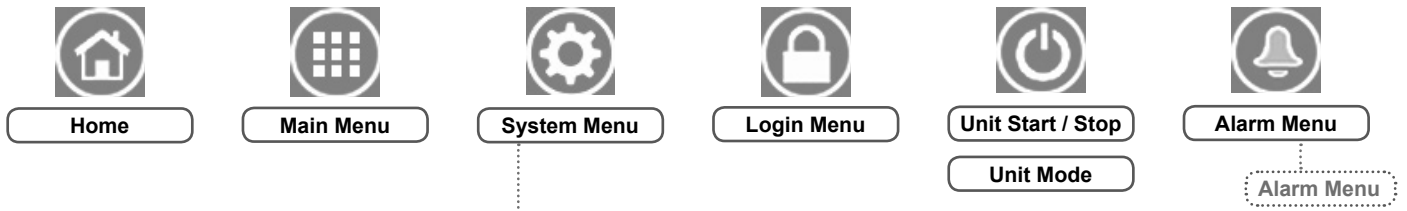

System Menu

CPU Load	EOL Resistor	Network
Date/Time Configuration	Language & Unit System	Brightness
Software Info	Hardware Info	





Alarm menu







Reset Alarms	Current Alarms
Alarm History	Major Alarm History

5 - CONNECT TOUCH USER INTERFACE



5.2 Header buttons





HOME SCREEN

Home button	Back button	Main Menu button	System Menu button
 Home screen displayed	 Go back to the previous screen	 Main Menu displayed	 System Menu displayed

Login button	Start/Stop button	Alarm button
 Basic access	 Unit is stopped	 No alarm active on the unit
 User access	 Unit is running	 <u>Blinking icon</u> : Partial alarm (one circuit affected by the existing alarm) or Alert (no action taken on the unit)  <u>Steady icon</u> : Alarm(s) active on the unit

OTHER SCREENS

Login screen	Parameters screen(s)
 Login: Confirm advanced access login	 Save changes
 Logout: Reset the user level access and go to the splash screen	 Cancel your modifications

Force screen (override)	Navigation buttons
 Set force: Override the current command (if possible)	 Displayed when the menu includes more than one page: Go to the previous page
 Remove force: Remove the forced command	 Displayed when the menu includes more than one page: Go to the next page

5 - CONNECT TOUCH USER INTERFACE

5.3 Explore the synoptic screen

The Synoptic screen allows you to monitor the vapour-refrigeration cycle. The diagram indicates the current status of the unit, giving information on the unit capacity, the status of water heat exchanger pumps, and the pre-defined setpoint parameter.

All unit functions can be accessed by pressing the **Main menu** button.

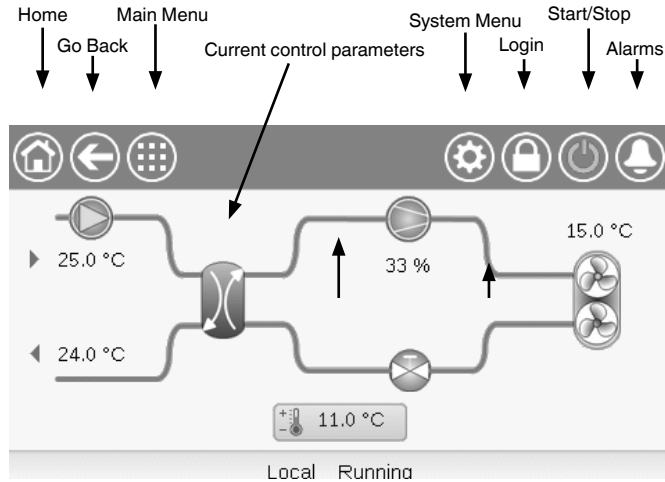

IMPORTANT: The Synoptic screen display may vary depending on pumps configuration.



The bell located in the upper-right part of the screen lights when any fault is detected.

5.4 Start/Stop the unit

With the unit in the Local off mode:

To display the list of operating modes and select the required mode, press the **Start/Stop** button  in the upper-right corner of the Synoptic screen.

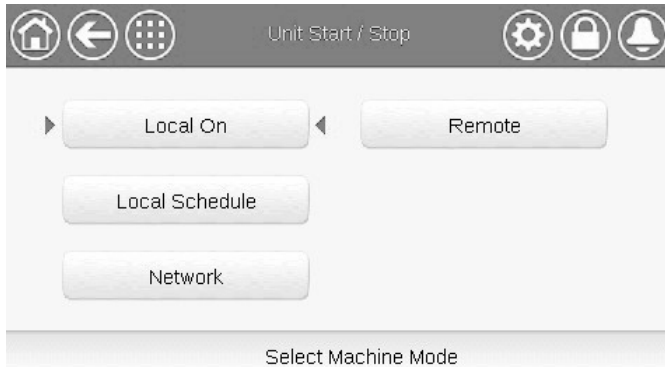

Local On	Local On: The unit is in the local control mode and allowed to start.
Local Schedule	Local Schedule: The unit is in the local control mode and allowed to start if the period is occupied.
Network	Network: The unit is controlled by network commands and allowed to start if the period is occupied.
Remote	Remote: The unit is controlled by external commands and allowed to start if the period is occupied.
Master	Master: The unit operates as the master in the master/slave assembly and allowed to start if the period is occupied. (Master button is displayed if Master/Slave Enable).

IMPORTANT:

When entering the menu, please note that the currently selected item corresponds to the last running operating mode.

This screen is displayed only when the unit is currently not running. If the unit was in the running state, then the Confirm stop message would be displayed.

To start the unit

1. Press the **Start/Stop** button.
2. Select the required Machine Mode.
3. The Welcome screen will be displayed.

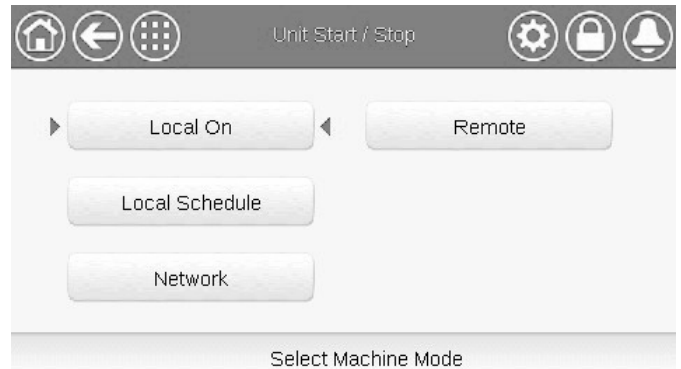

To stop the unit

1. Press the **Start/Stop** button.
2. Confirm the unit shutdown by pressing **Confirm Stop** or cancel the unit shutdown by pressing the **Back** button.

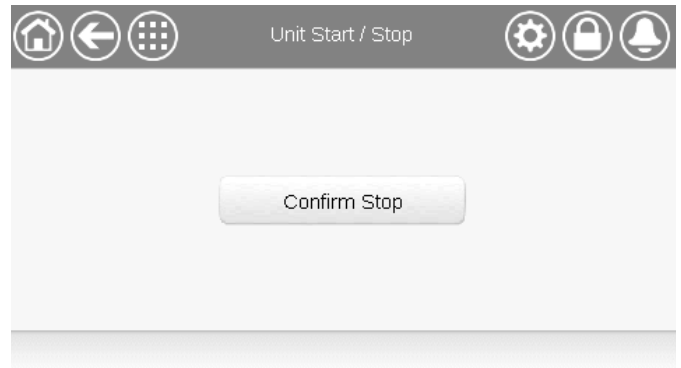

5 - CONNECT TOUCH USER INTERFACE

5.5 Set the schedule

The control incorporates two time schedules, where the first one (OCCPC01S) is used for controlling the unit start/stop, whereas the second one (OCCPC02S) is used for controlling the dual setpoint (Setpoint 1 used in Occupied mode / Setpoint 2 used in Unoccupied mode).

The control offers the user the possibility of setting eight occupancy periods where each occupancy period includes the following elements to be defined:

- Day of the week: Select the days when the period is occupied.
- Occupancy time ("occupied from" to "occupied to"): Set occupancy hours for the selected days.
- Timed Override Extension: Extend the schedule if necessary. This parameter can be used in the case of some unplanned events. Example: If the unit is normally scheduled to run between 8:00 to 18:00, but one day you want the air-conditioning system to operate longer, then set this timed override extension. If you set the parameter to "2", then the occupancy will end at 20:00.

NOTE: Time override extension is available only with the optional Energy Management Module.

To set the unit start/stop schedule

1. Go to the Main menu.
2. Navigate to the Configuration menu (logged-in users only) and select **Schedule Menu**  (SCHEDULE).
3. Go to **OCCPC01S**.
4. Select appropriate check boxes to set the unit occupancy on specific days.
5. Define the time of occupancy.
6. When the time schedule is set, the selected period will be presented in the form of the green band on the timeline.
7. Press the **Save** button to save your changes or the **Cancel** button to exit the screen without making modifications.

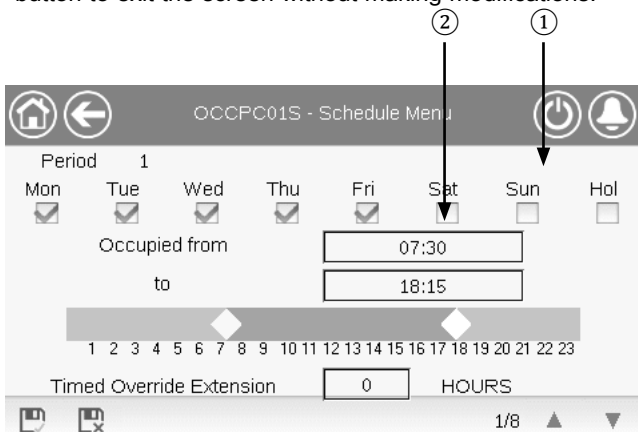

- ① Selection of days for the time schedule
- ② Start/end of the schedule
- ③ Save
- ④ Cancel
- ⑤ Previous time period
- ⑥ Next time period

IMPORTANT: Only logged-in users are allowed to access the Configuration menu.

Each program is in unoccupied mode unless a schedule time period is active.

If two periods overlap and are both active on the same day, **the occupied mode takes priority over the unoccupied period.**

Example: Schedule setting

Hour	MON	TUE	WED	THU	FRI	SAT	SUN	HOL
0:00	P1							
1:00	P1							
2:00	P1							
3:00								
4:00								
5:00								
6:00								
7:00	P2	P2	P3	P4	P4	P5		
8:00	P2	P2	P3	P4	P4	P5		
9:00	P2	P2	P3	P4	P4	P5		
10:00	P2	P2	P3	P4	P4	P5		
11:00	P2	P2	P3	P4	P4	P5		
12:00	P2	P2	P3	P4	P4			
13:00	P2	P2	P3	P4	P4			
14:00	P2	P2	P3	P4	P4			
15:00	P2	P2	P3	P4	P4			
16:00	P2	P2	P3	P4	P4			
17:00	P2	P2	P3					
18:00			P3					
19:00			P3					
20:00			P3					P6
21:00								
22:00								
23:00								

- MON: Monday
- TUE: Tuesday
- WED: Wednesday
- THU: Thursday
- FRI: Friday
- SAT: Saturday
- SUN: Sunday
- HOL: Holiday

Period / Schedule	Starts at	Stops at	Active on (days)
P1: Period 1	0:00	3:00	Monday
P2: Period 2	7:00	18:00	Monday + Tuesday
P3: Period 3	7:00	21:00	Wednesday
P4: Period 4	7:00	17:00	Thursday + Friday
P5: Period 5	7:00	12:00	Saturday
P6: Period 6	20:00	21:00	Holidays
P7: Period 7	Not used in this example		
P8: Period 8	Not used in this example		

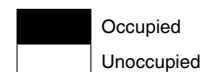

5 - CONNECT TOUCH USER INTERFACE

5.6 Manage display settings

The Language & Unit System screen allows the user to do any of the following:

- Select the language of the controller.
- Change the system of measurement (imperial or metric).

To access the User Login screen, press the **Login** button



in the upper-right corner of the Synoptic screen.

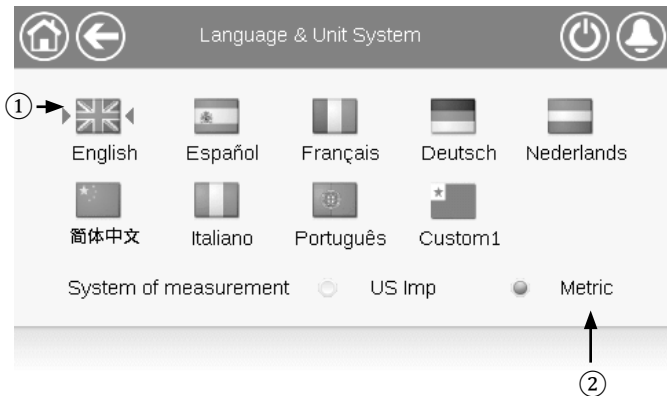

- ① Cursor indicating the selected language
- ② System of measurement: Metric/Imperial

NOTE: You may also leave the screen by pressing the **Back** button. Your changes will be saved.

The CONNECT TOUCH control system allows users to add new languages to the control. To learn more about language customization, please contact your local Manufacturer representative.

5.6.1 User login

Only logged-in users can access configurable unit parameters. By default, user password is "11".

To log in as user

1. Press the **Login** button to open User Login Screen.
2. Press the Password box.
3. A dialog box appears ("keyboard view"). Provide the password (11) and press **OK**.
4. The User Login screen appears.
5. Press the **Logged-in** button to save your changes or the **Logged-off** button to exit the screen without making modifications.

NOTE: You may also leave the screen by pressing the **Back** button.

Security access settings

- User-level security ensures that only authorised users are allowed to modify critical unit parameters.
- Only logged-in users are allowed to access the Configuration menu.
- It is strongly recommended to change the default password of the user interface to exclude the possibility of changing any parameters by an unqualified person.
- Only people qualified to manage the unit should be familiarized with the password.

5.6.2 User password

User password can be modified in the User Login menu.

To change your password

1. Press the **User Login** button, and then select *User Login*.
2. Press the **Change User Password** button.
3. The **Change User Password** screen will be displayed.
4. Please provide the current password, and then type the new password twice.
5. Press the **Save** button to confirm password update or the **Cancel** button to exit the screen without making modifications.

5.6.3 Service & Factory Login

Service and factory login menus are dedicated to CIAT service technicians and factory line. To learn more about advanced access control, please refer to the Control Service Guide (service technicians only).

5 - CONNECT TOUCH USER INTERFACE

5.7 Monitor unit parameters

The Main menu screen provides access to the main control parameters, including general parameters, inputs and outputs status, etc.

- To access the menu, press the **Main menu** button  located in the upper-left part of the Synoptic screen.
- Specific unit parameters can be accessed by pressing the icon corresponding to the desired category.
- To go back to the Synoptic screen, press the **Home** button.

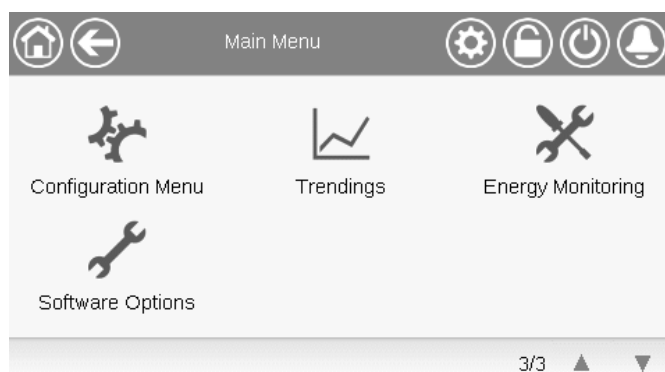
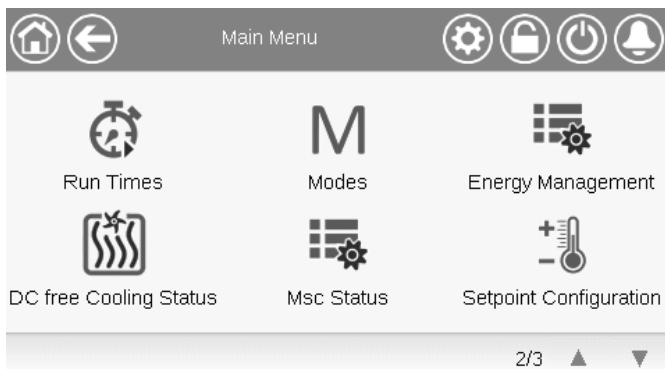
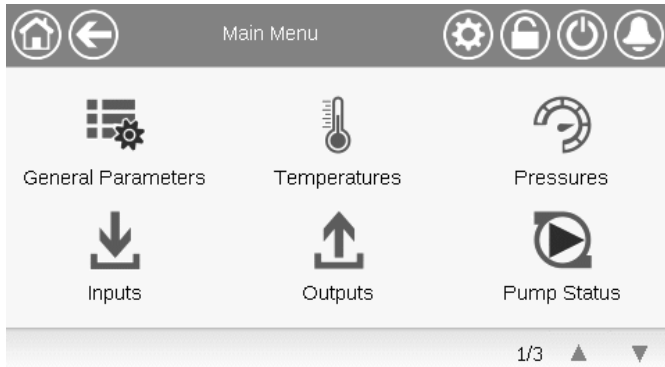

General unit parameters

The General parameters screen provides access to a set of general unit parameters.

- To access the General parameters screen, go to the Main menu and select **General Parameters**  (GENUNIT).
- Press the **Up/Down** buttons to navigate between the screens.

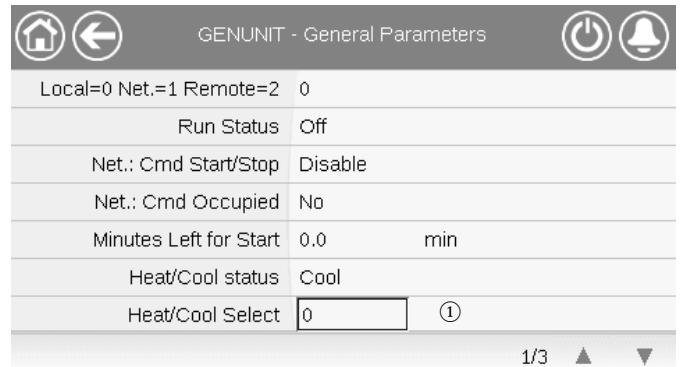



- ① Forceable point: In this example, it is used to change the unit mode – Cooling / Heating / Automatic changeover.

5 - CONNECT TOUCH USER INTERFACE

5.8 Modify unit parameters

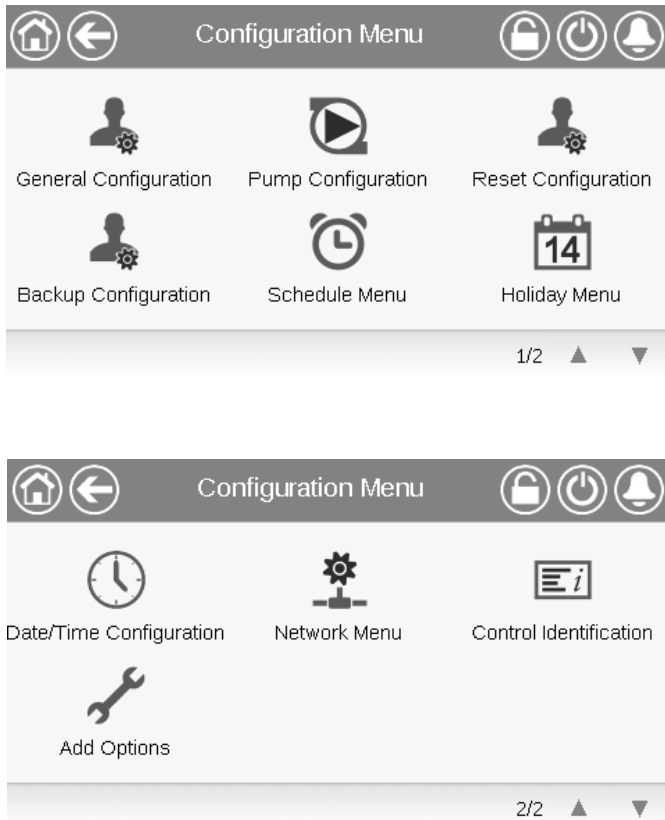
The Configuration menu gives access to a number of user-modifiable parameters such as pump configuration, schedule menu, etc. The Configuration menu is password-protected.



- To access the Configuration menu, press the **Main menu**  button located in the upper-left part of the Synoptic screen, and then find and press **Configuration Menu**.
- Press the field corresponding to the parameter to be modified and introduce all the necessary changes.
- Press the **Up/Down** buttons to navigate between the screens.
- Once all the necessary modifications have been made, press the **Save** button to save your changes or the **Cancel** button to exit the screen without making modifications.

5.9 Override system configuration

In some cases it is possible to override system configuration. The override screen provides the option to issue the command overriding the current operation of the unit.

To access the override screen, press the forceable point of the data screen. Note that not all parameters can be overridden by the control.

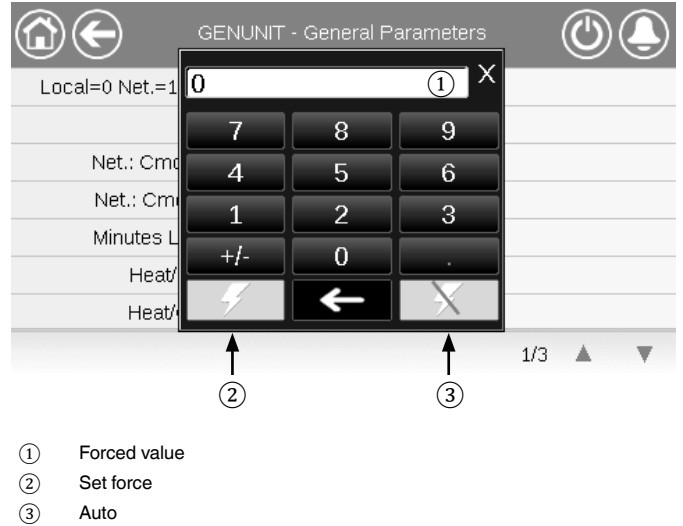

- ① Forced value
- ② Set force
- ③ Auto

5 - CONNECT TOUCH USER INTERFACE

5.10 Analyse history trends

The Trendings screen allows you to monitor a set of selected parameters.



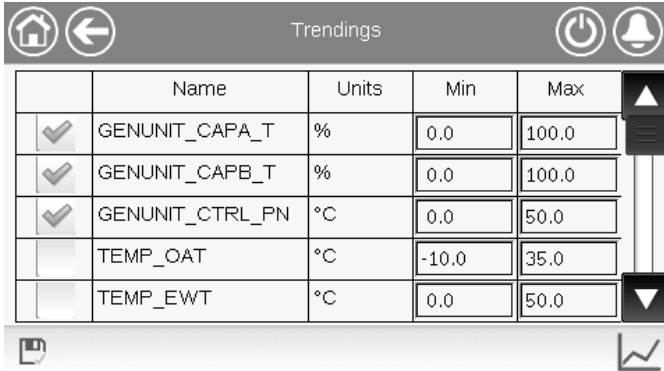

- To access the Trendings screen, go to the Main menu and select **Trendings**  (TRENDING).
- Select the parameters to be displayed and press the **Save** button in the lower-left part of the screen.

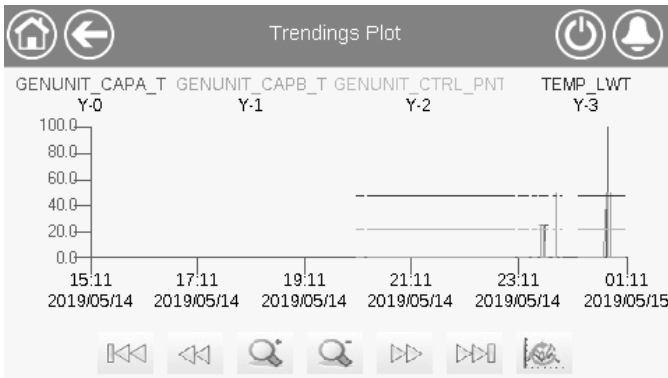



	Name	Units	Min	Max	
<input checked="" type="checkbox"/>	GENUNIT_CAPA_T	%	0.0	100.0	<input type="checkbox"/>
<input checked="" type="checkbox"/>	GENUNIT_CAPB_T	%	0.0	100.0	<input type="checkbox"/>
<input checked="" type="checkbox"/>	GENUNIT_CTRL_PN	°C	0.0	50.0	<input type="checkbox"/>
<input type="checkbox"/>	TEMP_OAT	°C	-10.0	35.0	<input type="checkbox"/>
<input type="checkbox"/>	TEMP_EWT	°C	0.0	50.0	<input type="checkbox"/>



IMPORTANT: Please make sure that dates are not out of range (not existing dates); otherwise, an error message may be displayed.

Press  or  to navigate across the timeline or press  or  to go to the beginning or the end of the selected period.

Press the **Zoom in** button  to magnify the view or the **Zoom out** button  to expand the viewed area.

Press the **Refresh** button  to reload data.

6 - WEB CONNECTION

6.1 Web interface

The CONNECT TOUCH control provides the functionality to access and control unit parameters from a web interface. To connect to the controller via the web interface, it is necessary to know the IP address of the unit.

To verify unit IP address:

1. Go to the System menu.
2. Select *Network* (NETWORK).
3. Verify TCP/IP Address for "IP Network Interface J5 (eth0)".
 - Unit default address:
169.254.1.1 (J5, eth0)
 - The unit IP address can be changed.

To access CONNECT TOUCH web interface:

1. Open the web browser.
2. Enter the IP address of the unit in the address bar of the web browser. Start with **https://** followed by the unit IP address.

Example: https://169.254.1.1

3. Press Enter.
4. The web interface will be loaded.

IMPORTANT: Three users can be connected simultaneously with no priority between them. The last modification is always taken into account.

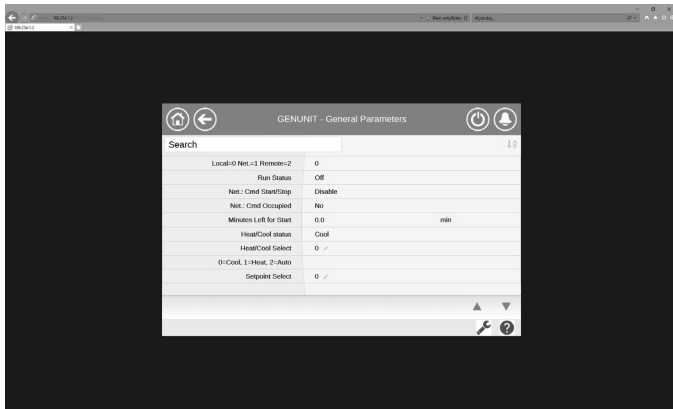

Minimum web browser configuration:

- Internet Explorer (version 11 or higher)
- Mozilla Firefox (version 60 or higher)
- Google Chrome (version 65 or higher)

For security reasons the unit cannot be started / stopped via the web interface. All other operations, including monitoring unit parameters or unit configuration, can be performed via the web browser interface.

Make sure that your network is protected from malicious attacks and any other security threats. Do not provide open access without proper network security safeguards.

CIAT does not hold any responsibility or liability for damage caused by security breach.

6.2 Technical documentation

When using the CONNECT TOUCH control via a PC web browser, you may easily access all technical documents related to the product and its components.

Once you connect to the CONNECT TOUCH control, click the **Technical documentation** button  in order to see a list of documents related to the unit.

Technical documentation includes the following documents:

- Spare parts documentation: The list of spare parts included in the unit with reference, description and drafting.
- Misc: Documents such as electrical plans, dimension plans, unit certificates.
- PED: Pressure Equipment Directive.
- IOM: Installation operation and maintenance manual, controls installation/maintenance manual.

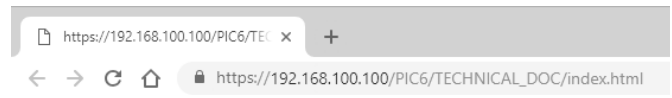









Document	Language	Type
BACnet User's guide	English	PDF
ModBus User's guide	English	PDF
License information	English	PDF

Click the **Help** button  to get access to BACnet user guide, Modbus user guide and Open Source Licenses used by CONNECT TOUCH.

IMPORTANT: Please save all data (documents, drawings, diagrams, etc.), for example, on your computer. If the display is replaced, all documents will be lost. Make sure that all documents are stored and may be accessed at any time.

7 - CONNECT TOUCH CONTROL: MENU STRUCTURE

7.1 Main menu

Icon	Displayed text*	Description	Name
	General Parameters	General parameters	GENUNIT
	Temperatures	Temperatures	TEMP
	Pressures	Pressures	PRESSURE
	Inputs	Inputs status	INPUTS
	Outputs	Outputs status	OUTPUTS
	Pump Status	Pump status	PUMPSTAT
	Run Times	Run times	RUNTIME
	Modes	Modes status	MODES
	Energy Management	Energy management status	EMM_STAT
	DC Free Cooling Status	DC Free Cooling Status	DCFC_STA
	Msc Status	Miscellaneous parameters status	MSC_STAT
	Trendings	Trendings **	TRENDING
	Setpoint Configuration	Setpoints configuration	SETPOINT
	Configuration Menu	Configuration menu (see section 7.2)	CONFIG
	Energy Monitoring	Energy Monitoring	ENERGY
	Software Options	Software Options	OPT_STA

* Depends on the selected language (English by default).

** The Trendings menu is displayed in form of a graph; hence, it is not included in this section of the document (see section 5.10).

CAUTION

Since specific units may not include additional features, some tables may contain parameters that cannot be configured for a given unit.

7 - CONNECT TOUCH CONTROL: MENU STRUCTURE



General Parameters Menu – GENUNIT

	Name	Status	Default	Unit	Displayed text*	Description
1	CTRL_TYP	0 to 2	0	-	Local=0 Net.=1 Remote=2	Operating mode: 0 = Local 1 = Network 2 = Remote
2	STATUS	-	-	-	Run Status	Unit running status: Off, Stopping, Delay, Running, Ready, Override, Tripout, Test, Runtest
3	CHIL_S_S	disable/enable	disable	-	Net.: Cmd Start/Stop	Unit start/stop via Network: When the unit is in Network mode, start/stop command can be forced
4	CHIL_OCC	no/yes	no	-	Net.: Cmd Occupied	Unit time schedule via Network: When the unit is in Network mode, the forced value can be used instead of the real occupancy state
5	min_left	-	-	min	Minutes Left for Start	Minutes before the unit start-up
6	HEATCOOL	Cool/Heat/ Standby/Both	-	-	Heat/Cool status	Heating/cooling status
7	HC_SEL	0 to 2	0	-	Heat/Cool Select	Heating/cooling selection
8					0=Cool, 1=Heat, 2=Auto	0 = Cooling 1 = Heating 2 = Automatic heating/cooling control
9	SP_SEL	0 to 2	0	-	Setpoint Select	Setpoint selection
10					0=Auto, 1=Spt1, 2=Spt2	0 = Automatic setpoint selection 1 = Setpoint 1 (active during occupied period) 2 = Setpoint 2 (active during unoccupied period)
11	SP_OCC	no/yes	yes	-	Setpoint Occupied?	Setpoint status: 0 = Unoccupied 1 = Occupied
12	CAP_T	-	-	%	Unit Total Capacity	Total unit capacity
13	CAPA_T	-	-	%	Cir A Total Capacity	Total capacity, circuit A
14	CAPB_T	-	-	%	Cir B Total Capacity	Total capacity, circuit B
15	SP	-	-	°C / °F	Current Setpoint	Current setpoint
16	CTRL_PNT	-	-	°C / °F	Control Point	Control point: Water temperature that the unit must produce
17	CTRL_WT	-	-	°C / °F	Control Water Temp	Controlled water temperature
18	OAT	-	-	°C / °F	Outdoor Air Temp	Outdoor air temperature
19	EMSTOP	disable/enable	disable	-	Emergency Stop	Emergency stop: Used to stop the unit regardless of its active operating type
20	DEM_LIM	0 to 100	0	%	Active Demand Limit Val	Active demand limit value: When the unit is in Network mode, the minimum value will be used compared to the status of the external limit switch contact and the demand limit switch setpoint
21	LAG_LIM	0 to 100	0	%	Lag Capacity Limit Value	Lag capacity limit value: Value that is forced by the master chiller (master/slave assembly)

* Depends on the selected language (English by default).



Temperatures Menu – TEMP

	Name	Status	Default	Unit	Displayed text*	Description
1	EWT	-	-	°C / °F	Entering Fluid Temp	Evaporator entering water temperature: Used for capacity control
2	LWT	-	-	°C / °F	Leaving Fluid Temp	Evaporator leaving water temperature: Used for capacity control
3	OAT	-	-	°C / °F	Outdoor Air Temp	Outdoor air temperature: Used to determine a number of control mechanisms such as heat/cool changeover, heater operation, defrost cycle, and more
4	SCT_A	-	-	°C / °F	Saturated Cond Tmp cir A	Saturated condensing temperature, circuit A
5	SST_A	-	-	°C / °F	Saturated Suction Temp A	Saturated suction temperature, circuit A
6	SUCT_A	-	-	°C / °F	Compressor Suction Tmp A	Compressor suction temperature, circuit A
7	SH_A	-	-	°C / °F	Suction Superheat Tmp A	Suction superheat temperature, circuit A
8	DEFRT_A	-	-	°C / °F	Defrost Temperature A	Defrost temperature, circuit A (heat pumps)
9	SCT_B	-	-	°C / °F	Saturated Cond Tmp cir B	Saturated condensing temperature, circuit B
10	SST_B	-	-	°C / °F	Saturated Suction Temp B	Saturated suction temperature, circuit B
11	SUCT_B	-	-	°C / °F	Compressor Suction Tmp B	Compressor suction temperature, circuit B
12	SH_B	-	-	°C / °F	Suction Superheat Tmp B	Suction superheat temperature, circuit B
13	DEFRT_B	-	-	°C / °F	Defrost Temperature B	Defrost temperature, circuit B (heat pumps)
14	SPACETMP	-	-	°C / °F	Optional Space Temp	Space (room) temperature: Applies to units with the optional Energy Management Module
15	CHWSTEMP	-	-	°C / °F	Cold Water System Temp	Cold water system temperature

* Depends on the selected language (English by default).

7 - CONNECT TOUCH CONTROL: MENU STRUCTURE



Pressures Menu – PRESSURE

	Name	Status	Default	Unit	Displayed text*	Description
1	DP_A	-	-	kPa / PSI	Discharge Pressure A	Compressor discharge pressure, circuit A
2	SP_A	-	-	kPa / PSI	Main Suction Pressure A	Compressor suction pressure, circuit A
3	DP_B	-	-	kPa / PSI	Discharge Pressure B	Compressor discharge pressure, circuit B
4	SP_B	-	-	kPa / PSI	Main Suction Pressure B	Compressor suction pressure, circuit B
5	PUMP_EWP	-	-	kPa / PSI	Inlet unit water pres.	Pump entering water pressure
6	PUMP_LWP	-	-	kPa / PSI	Outlet unit water pres.	Pump leaving water pressure

* Depends on the selected language (English by default).



Inputs Menu – INPUTS

	Point name	Status	Default	Unit	Displayed text*	Description
1	ONOFF_SW	open/close	open	-	Remote On/Off Switch	Remote on/off switch
2	HC_SW	open/close	open	-	Remote HeatCool Switch	Remote heating/cooling selection switch
3	SETP_SW	open/close	open	-	Remote Setpoint Switch	Remote setpoint selection switch
4	LIM_SW1	open/close	open	-	Limit Switch 1	Demand limit switch 1
5	LIM_SW2	open/close	open	-	Limit Switch 2	Demand limit switch 2 (Energy Management Module)
6	LOCK_SW	open/close	open	-	Customer Interlock	Customer interlock: When the contact is closed, the unit will be stopped with no delay. The switch is provided on the customer's terminal block of the optional Energy Management Module
7	FLOW_SW	open/close	open	-	Flow Switch Status	Flow switch status
8	DSHTR_SW	open/close	open	-	Desuper heater demand	Desuperheater status
9	REM_LOCK	open/close	open	-	Remote Interlock Status	Remote interlock status
10	REVPH_SW	open/close	open	-	Reverse Phase Detection	Reverse phase detection
11	cp_a1_f	open/close	open	-	Compressor A1 failure	Compressor A1 failure
12	cp_a2_f	open/close	open	-	Compressor A2 failure	Compressor A2 failure
13	cp_a3_f	open/close	open	-	Compressor A3 failure	Compressor A3 failure
14	cp_a4_f	open/close	open	-	Compressor A4 failure	Compressor A4 failure
15	HP_SW_A	open/close	open	-	High Pressure Switch A	High pressure switch, circuit A
16	LEAK_A	-	-	V	Leakage Detector Val A	Leakage detector, circuit A
17	cp_b1_f	open/close	open	-	Compressor B1 failure	Compressor B1 failure
18	cp_b2_f	open/close	open	-	Compressor B2 failure	Compressor B2 failure
19	cp_b3_f	open/close	open	-	Compressor B3 failure	Compressor B3 failure
20	cp_b4_f	open/close	open	-	Compressor B4 failure	Compressor B4 failure
21	HP_SW_B	open/close	open	-	High Pressure Switch B	High pressure switch, circuit B
23	LEAK_B	-	-	V	Leakage Detector Val B	Leakage detector, circuit B

* Depends on the selected language (English by default).

7 - CONNECT TOUCH CONTROL: MENU STRUCTURE



Outputs Menu – OUTPUTS

	Point name	Status	Default	Unit	Displayed text*	Description
1	CP_A1	off/on	off	-	Compressor A1	Compressor A1 command
2	CP_A2	off/on	off	-	Compressor A2	Compressor A2 command
3	CP_A3	off/on	off	-	Compressor A3	Compressor A3 command
4	CP_A4	off/on	off	-	Compressor A4	Compressor A4 command
5	FAN_A1_0	off/on	off	-	Fan A1 Low Speed	Fan A1 low speed (optional)
6	FAN_A1_1	off/on	off	-	Fan A1 High Speed	Fan A1 command
7	FAN_A2	off/on	off	-	Fan A2	Fan A2 command
8	FAN_A3	off/on	off	-	Fan A3	Fan A3 command
9	FAN_A4	off/on	off	-	Fan A4	Fan A4 command
10	FAN_ST_A	0 to 6	0	-	Fan Staging Number Cir A	Current fan stage of circuit A
11	VARFAN_A	0 to 100	0	%	Variable fan A command	Variable fan A command
12	EXV_A	0 to 100	0	%	EXV position Circuit A	EXV position, circuit A
13	REV_A	off/on	off	-	4-way Refrig. Valve A	4-way refrigerant valve, circuit A: Used to manage cooling / heating / defrost operation (heat pumps)
14	HD_HTR_A	off/on	off	-	Compressor Head Heater A	Compressor head heater, circuit A (only units with variable speed fans controlled through the internal bus)
15	CP_B1	off/on	off	-	Compressor B1	Compressor B1 command
16	CP_B2	off/on	off	-	Compressor B2	Compressor B2 command
17	CP_B3	off/on	off	-	Compressor B3	Compressor B3 command
18	CP_B4	off/on	off	-	Compressor B4	Compressor B4 command
19	FAN_B1_0	off/on	off	-	Fan B1 Low Speed	Fan B1 low speed (optional)
20	FAN_B1_1	off/on	off	-	Fan B1 High Speed	Fan B1 command
21	FAN_B2	off/on	off	-	Fan B2	Fan B2 status
22	FAN_B3	off/on	off	-	Fan B3	Fan B3 status
23	FAN_B4	off/on	off	-	Fan B4	Fan B4 status
24	FAN_ST_B	0 to 6	0	-	Fan Staging Number Cir B	Current fan stage of circuit B
25	VARFAN_B	0 to 100	0	%	Variable fan B command	Variable fan B command
26	EXV_B	0 to 100	0	%	EXV position Circuit B	EXV position, circuit B
27	REV_B	off/on	off	-	4-way Refrig. Valve B	4-way refrigerant valve, circuit B: Used to manage cooling / heating / defrost operation (heat pumps)
28	HD_HTR_B	off/on	off	-	Compressor Head Heater B	Compressor head heater, circuit B (only units with variable speed fans controlled through the internal bus)
29	ALARM	off/on	off	-	Alarm Relay Status	Alarm relay status
30	RUNNING	off/on	off	-	Running Relay Status	Running relay status
31	ALERT	off/on	off	-	Alert Relay State	Alert relay status
32	SHUTDOWN	off/on	off	-	Shutdown Indicator State	Shutdown indicator state
33	EXCH_HTR	off/on	off	-	Exchanger Heater	Water exchanger heater
34	SET_FLOW	off/on	off	-	Flow Switch Setpoint cfg	Flow switch setpoint configuration

* Depends on the selected language (English by default).



Pump Status Menu – PUMPSTAT

	Name	Status	Default	Unit	Displayed text*	Description
1	ROTWPUMP	no/yes	no	-	Rotate Water Pumps Now?	Water pumps rotation
2	WPUMP_1	off/on	off	-	Water Pump #1 Command	Water pump 1 control
3	WPUMP_2	off/on	off	-	Water Pump #2 Command	Water pump 2 control
4	wp_out	-	-	kPa / PSI	Outlet Water Pres.(cor)	Outlet water pressure (corrected by temperature) Applies to units with the hydronic kit option
5	wp_in	-	-	kPa / PSI	Inlet Water Pres.(cor)	Inlet water pressure (corrected by temperature) Applies to units with the hydronic kit option
6	WP_CAL	no/yes	no	-	Water Pres. Calibration?	Water pressure calibration
7	wp_off	-	-	kPa / PSI	Water Pressure Offset	Water pressure offset
8	wp_filt	-	-	kPa / PSI	Delta Pressure Filter	Delta pressure filter
9	wp_min	-	-	kPa / PSI	Minimum Water Pressure	Minimum water pressure
10	flow	-	-	l/s / GPM	Water Flow	Water flow rate
11	dt_stp	-	-	°C / °F	Water Delta T Setpoint	Water delta temperature setpoint
12	delta_t	-	-	°C / °F	Current Water Delta T	Current water delta temperature
13	dp_stp	-	-	kPa / PSI	Water Delta P Setpoint	Water delta pressure setpoint
14	delta_p	-	-	kPa / PSI	Current Water Delta P	Current water delta pressure
15	DRV_OUT	0 to 100	0	%	Drive Output	Drive output

* Depends on the selected language (English by default).

7 - CONNECT TOUCH CONTROL: MENU STRUCTURE



Run Times Menu – RUNTIME

	Name	Status	Default	Unit	Displayed text*	Description
1	hr_mach	-	-	hour	Machine Operating Hours	Unit operating hours
2	st_mach	-	-	-	Machine Starts Number	Number of unit starts
3	hr_cp_a1	-	-	hour	Compressor A1 Hours	Operating hours, compressor A1
4	hr_cp_a2	-	-	hour	Compressor A2 Hours	Operating hours, compressor A2
5	hr_cp_a3	-	-	hour	Compressor A3 Hours	Operating hours, compressor A3
6	hr_cp_a4	-	-	hour	Compressor A4 Hours	Operating hours, compressor A4
7	hr_cp_b1	-	-	hour	Compressor B1 Hours	Operating hours, compressor B1
8	hr_cp_b2	-	-	hour	Compressor B2 Hours	Operating hours, compressor B2
9	hr_cp_b3	-	-	hour	Compressor B3 Hours	Operating hours, compressor B3
10	hr_cp_b4	-	-	hour	Compressor B4 Hours	Operating hours, compressor B4
11	st_cp_a1	-	-	-	Compressor A1 Starts	Number of starts, compressor A1
12	st_cp_a2	-	-	-	Compressor A2 Starts	Number of starts, compressor A2
13	st_cp_a3	-	-	-	Compressor A3 Starts	Number of starts, compressor A3
14	st_cp_a4	-	-	-	Compressor A4 Starts	Number of starts, compressor A4
15	st_cp_b1	-	-	-	Compressor B1 Starts	Number of starts, compressor B1
16	st_cp_b2	-	-	-	Compressor B2 Starts	Number of starts, compressor B2
17	st_cp_b3	-	-	-	Compressor B3 Starts	Number of starts, compressor B3
18	st_cp_b4	-	-	-	Compressor B4 Starts	Number of starts, compressor B4
19	hr_fana1	-	-	hour	Fan A1 Hours	Operating hours, fan A1
20	hr_fana2	-	-	hour	Fan A2 Hours	Operating hours, fan A2
21	hr_fana3	-	-	hour	Fan A3 Hours	Operating hours, fan A3
22	hr_fana4	-	-	hour	Fan A4 Hours	Operating hours, fan A4
23	hr_fanb1	-	-	hour	Fan B1 Hours	Operating hours, fan B1
24	hr_fanb2	-	-	hour	Fan B2 Hours	Operating hours, fan B2
25	hr_fanb3	-	-	hour	Fan B3 Hours	Operating hours, fan B3
26	hr_fanb4	-	-	hour	Fan B4 Hours	Operating hours, fan B4
27	hr_pump1	-	-	hour	Water Pump #1 Hours	Operating hours, water pump 1
28	hr_pump2	-	-	hour	Water Pump #2 Hours	Operating hours, water pump 2
29	hr_hrmp	-	-	hour	Reclaim Pump Hours	NOT applicable to your unit. Please ignore this parameter.
30	hrfcmpa	-	-	hour	Refrig. Pump Cir A Hours	NOT applicable to your unit. Please ignore this parameter.
31	hrfcmpb	-	-	hour	Refrig. Pump Cir B Hours	NOT applicable to your unit. Please ignore this parameter.
32	nb_defra	-	-	-	Circuit A Defrost Number	Defrost session number, circuit A
33	nb_defrb	-	-	-	Circuit B Defrost Number	Defrost session number, circuit B

* Depends on the selected language (English by default).

NOTE: Only the Dry Cooler Free Cooling is available on CIAT units.

7 - CONNECT TOUCH CONTROL: MENU STRUCTURE

M Modes Menu – MODES

	Name	Status	Default	Unit	Displayed text*	Description
1	m_delay	no/yes	no	-	Start Up Delay In Effect	Start-up delay in effect
2	m_2stpt	no/yes	no	-	Second Setpoint In Use	Second setpoint in use: The setpoint used during unoccupied periods
3	m_reset	no/yes	no	-	Reset In Effect	Setpoint reset active
4	m_demlim	no/yes	no	-	Demand limit active	Demand limit active
5	m_rpload	no/yes	no	-	Ramp Loading Active	Ramp loading active
6	m_whtr	no/yes	no	-	Water Exchanger Heater	Water exchanger heater active
7	m_pmprot	no/yes	no	-	Water Pump Rotation	Water pump rotation
8	m_pmpper	no/yes	no	-	Pump Periodic Start	Pump periodic start
9	m_lowscA	no/yes	no	-	Low Suction Circuit A	Low suction, circuit A
10	m_lowscB	no/yes	no	-	Low Suction Circuit B	Low suction, circuit B
11	m_hidgta	no/yes	no	-	High DGT Circuit A	High DGT, circuit A
12	m_hidgtb	no/yes	no	-	High DGT Circuit B	High DGT, circuit B
13	m_hiprsa	no/yes	no	-	High Press Override CirA	High pressure override, circuit A
14	m_hiprsb	no/yes	no	-	High Press Override CirB	High pressure override, circuit B
15	m_lowsha	no/yes	no	-	Superheat Override Cir A	Superheat override, circuit A
16	m_lowshb	no/yes	no	-	Superheat Override Cir B	Superheat override, circuit B
17	m_dltP_a	no/yes	no	-	Low Delta Press Cir A	Low delta pressure, circuit A
18	m_dltP_b	no/yes	no	-	Low Delta Press Cir B	Low delta pressure, circuit B
19	m_night	no/yes	no	-	Night Low Noise Active	Night low noise active
20	m_hsm	no/yes	no	-	System Manager Active	System Manager active
21	m_slave	no/yes	no	-	Master Slave Active	Master/slave mode active
22	m_autoch	no/yes	no	-	Auto Changeover Active	Automatic changeover active
23	m_defr_a	no/yes	no	-	Defrost Active Circuit A	Defrost mode active, circuit A (heat pumps)
24	m_defr_b	no/yes	no	-	Defrost Active Circuit B	Defrost mode active, circuit B (heat pumps)
25	m_recl_a	no/yes	no	-	Reclaim Active Circuit A	NOT applicable to your unit. Please ignore this parameter.
26	m_recl_b	no/yes	no	-	Reclaim Active Circuit B	NOT applicable to your unit. Please ignore this parameter.
27	m_free_a	no/yes	no	-	Free Cooling Active A	NOT applicable to your unit. Please ignore this parameter.
28	m_free_b	no/yes	no	-	Free Cooling Active B	NOT applicable to your unit. Please ignore this parameter.
29	m_boiler	no/yes	no	-	Boiler Active	Boiler active
30	m_ehs	no/yes	no	-	Electric Heater Active	Electric heater active
31	m_ewtlck	no/yes	no	-	Heating Low EWT Lockout	Heating low EWT lockout
32	m_ice	no/yes	no	-	Ice Mode In Effect	Ice mode active

* Depends on the selected language (English by default).

Energy Management Menu – EMM_STAT

	Name	Status	Default	Unit	Displayed text*	Description
1	OCC_OVSW	open/close	open	-	Occupied Override Switch	Occupied override switch status
2	ICE_SW	open/close	open	-	Ice Done Storage Switch	Ice done storage switch status
3	SP_RESET	4 to 20	0	mA	Setpoint Reset Signal	Setpoint reset signal
4	LIM_4_20	4 to 20	0	mA	Limit 4-20mA Signal	Limit 4-20 mA signal
7	CAPT_010	-	-	V	Chiller Capacity Running	Chiller capacity running: 0 to 10 VDC signal corresponding to 0-100% capacity
8	BOILER	off/on	off	-	Boiler Output	Boiler output
9	EHS1	off/on	off	-	Electrical Heat Stage 1	Electric heater stage 1 (heat pumps)
10	EHS2	off/on	off	-	Electrical Heat Stage 2	Electric heater stage 2 (heat pumps)
11	EHS3	off/on	off	-	Electrical Heat Stage 3	Electric heater stage 3 (heat pumps)
12	EHS4	off/on	off	-	Electrical Heat Stage 4	Electric heater stage 4 (heat pumps)
13	ALERT	off/on	off	-	Alert Relay Status	Alert relay status
14	DSH_PUMP	off/on	off	-	Desuperheater Pump	Desuperheater pump status (partial heat reclaim)

* Depends on the selected language (English by default).

7 - CONNECT TOUCH CONTROL: MENU STRUCTURE



DC Free Cooling Status Menu – DCFC_STA

	Name	Status	Default	Unit	Displayed text*	Description
1	oat	-	-	°C / °F	OAT Free Cooling	Dry Cooler Free Cooling: OAT
2	lwt	-	-	°C / °F	FC Leaving Water Temp	Dry Cooler Free Cooling: Leaving water temperature
3	wloop	-	-	°C / °F	FC Water Loop Temp	Dry Cooler Free Cooling: Water loop temperature
4	m_dcfc	no/yes	no	-	Free Cooling Mode Active	Dry Cooler Free Cooling mode active
5	dcfc_cap	0 to 100	0	%	FC Capacity	Dry Cooler Free Cooling capacity
6	f_stage	0 to 20	0	-	Fix Speed Fans Stage	Dry Cooler Free Cooling: Fan stage (fixed speed fans)
7	vf_speed	0 to 100	0	%	Varifan Speed	Dry Cooler Free Cooling: Fan speed (variable speed)
8	pid_out	0 to 100	-	%	PID Output	Status of PID output
9	FC_HOUR	0 to 999999	-	hour	DCFC Operating Hours	Dry Cooler Free Cooling: Operating hours
10	FC_FAN1S	0 to 999999	-	-	DCFC Fan Stage 1 Start	DCFC / Fan stage 1: Number of starts
11	FC_FAN1H	0 to 999999	-	hour	DCFC Fan Stage 1 Hours	DCFC / Fan stage 1: Operating hours
12	FC_FAN2S	0 to 999999	-	-	DCFC Fan Stage 2 Start	DCFC / Fan stage 2: Number of starts
13	FC_FAN2H	0 to 999999	-	hour	DCFC Fan Stage 2 Hours	DCFC / Fan stage 2: Operating hours
14	FC_FAN3S	0 to 999999	-	-	DCFC Fan Stage 3 Start	DCFC / Fan stage 3: Number of starts
15	FC_FAN3H	0 to 999999	-	hour	DCFC Fan Stage 3 Hours	DCFC / Fan stage 3: Operating hours
16	FC_FAN4S	0 to 999999	-	-	DCFC Fan Stage 4 Start	DCFC / Fan stage 4: Number of starts
17	FC_FAN4H	0 to 999999	-	hour	DCFC Fan Stage 4 Hours	DCFC / Fan stage 4: Operating hours
18	FC_FAN5S	0 to 999999	-	-	DCFC Fan Stage 5 Start	DCFC / Fan stage 5: Number of starts
19	FC_FAN5H	0 to 999999	-	hour	DCFC Fan Stage 5 Hours	DCFC / Fan stage 5: Operating hours
20	FC_FAN6S	0 to 999999	-	-	DCFC Fan Stage 6 Start	DCFC / Fan stage 6: Number of starts
21	FC_FAN6H	0 to 999999	-	hour	DCFC Fan Stage 6 Hours	DCFC / Fan stage 6: Operating hours
22	FC_FAN7S	0 to 999999	-	-	DCFC Fan Stage 7 Start	DCFC / Fan stage 7: Number of starts
23	FC_FAN7H	0 to 999999	-	hour	DCFC Fan Stage 7 Hours	DCFC / Fan stage 7: Operating hours
24	FC_VFANS	0 to 999999	-	-	DCFC Variable Fan Start	DCFC / Variable speed fan: Number of starts
25	FC_VFANH	0 to 999999	-	hour	DCFC Variable Fan Hours	DCFC / Variable speed fan: Operating hours

* Depends on the selected language (English by default).



Msc Status Menu – MSC_STAT

	Name	Status	Default	Unit	Displayed text*	Description
1	m_ecopmp	no/yes	no	-	Eco Pump Mode Active	Eco pump mode status: When this mode is active, the pump is stopped periodically when the unit is in Standby

* Depends on the selected language (English by default).

7 - CONNECT TOUCH CONTROL: MENU STRUCTURE

Setpoint Configuration Menu – SETPOINT

	Name	Status	Default	Unit	Displayed text*	Description
1	csp1	-28.98 to 26.35 -20.0 to 78.8	11.0 51.8	°C °F	Cooling Setpoint 1	Cooling setpoint 1
2	csp2	-28.98 to 26.35 -20.0 to 78.8	11.0 51.8	°C °F	Cooling Setpoint 2	Cooling setpoint 2
3	ice_sp	-28.98 to 26.35 -20.0 to 78.8	11.0 51.8	°C °F	Cooling Ice Setpoint	Cooling ice setpoint
4	cramp_sp	0.11 to 1.12 0.2 to 2.0	0.6 33.08	°C °F	Cooling Ramp Loading	Cooling ramp loading
5	hsp1	20.30 to 63.64 68.0 to 145.4	37.8 100.04	°C °F	Heating Setpoint 1	Heating setpoint 1
6	hsp2	20.30 to 63.64 68.0 to 145.4	37.8 100.04	°C °F	Heating Setpoint 2	Heating setpoint 2
7	hramp_sp	0.11 to 1.12 0.2 to 2.0	0.6 33.08	°C °F	Heating Ramp Loading	Heating ramp loading
8	cauto_sp	4.06 to 50.54 39.0 to 122.0	23.9 75.0	°C °F	Cool Changeover Setpt	Cooling changeover setpoint
9	hautosp	0.14 to 46.62 32.0 to 115.0	17.8 64.0	°C °F	Heat Changeover Setpt	Heating changeover setpoint
10	lim_sp1	0 to 100	100	%	Switch Limit Setpoint 1	Switch limit setpoint 1
11	lim_sp2	0 to 100	100	%	Switch Limit Setpoint 2	Switch limit setpoint 2
12	lim_sp3	0 to 100	100	%	Switch Limit Setpoint 3	Switch limit setpoint 3
13	hr_stp	35.42 to 50.54 95.0 to 122.0	50.0 122.0	°C °F	Heat Reclaim Setpoint	Not applicable
14	hr_deadb	2.80 to 15.12 5.0 to 27.0	5.0 41.0	°C °F	Heat Reclaim Deadband	Not applicable
15	min_sct	24.22 to 50.54 75.0 to 122.0	40.0 104.0	°C °F	Desuperheat Min SCT	Desuperheater minimum saturated condensing temperature

* Depends on the selected language (English by default).

Trendings – TRENDING

	Name	Status	Default	Unit	Displayed text*
1	GENUNIT_CAPA_T	0 to 100	%	Cir A Total Capacity	Total capacity, circuit A
2	GENUNIT_CAPB_T	0 to 100	%	Cir B Total Capacity	Total capacity, circuit B
3	GENUNIT_CTRL_PNT	-	°C / °F	Control Point	Control point
4	TEMP_OAT	-	°C / °F	Outdoor Air Temp	Outdoor air temperature
5	TEMP_EWT	-	°C / °F	Cooler Entering Fluid	Evaporator entering water temperature
6	TEMP_LWT	-	°C / °F	Cooler Leaving Fluid	Evaporator leaving water temperature
7	TEMP_SCT_A	-	°C / °F	Saturated Cond Tmp cir A	Saturated condensing temperature, circuit A
8	TEMP_SCT_B	-	°C / °F	Saturated Cond Tmp cir B	Saturated condensing temperature, circuit B
9	TEMP_SST_A	-	°C / °F	Saturated Suction Temp A	Saturated suction temperature, circuit A
10	TEMP_SST_B	-	°C / °F	Saturated Suction Temp B	Saturated suction temperature, circuit B

* Depends on the selected language (English by default).

** The list of trending points cannot be modified. Trending points can only be enabled or disabled.

7 - CONNECT TOUCH CONTROL: MENU STRUCTURE



Energy Monitoring – ENERGY

	Name	Status	Default	Unit	Displayed text*
1				COOLING MODE	Cooling mode
2	cPwrOut	-	kW	Cooling Power Output	
3	cPwrIn	-	kW	Electical Power Input	
4	eer	-	-	Energy Efficiency (EER)	
5	cEnergyOu	-	kWh	Cooling Energy Output	
6	cEnergyIn	-	kWh	Electical Energy Input	
7	energyEer	-	-	Integrated EER	
8				HEATING MODE	Heating mode
9	hPwrOut	-	kW	Heating Power Output	
10	hPwrIn	-	kW	Electical Power Input	
11	cop	-	-	Coef. Of Perf. (COP)	
12	hEnergyOu	-	kWh	Heating Energy Output	
13	hEnergyIn	-	kWh	Electical Energy Input	
14	energyCop	-	-	Integrated COP	
15					
16	reset_en	no/yes	-	Reset of Energy Counter	Parameter set to "yes" allows to reset the energies displayed in this table
17	reset_da		-	Last Reset Date	
18	reset_ti		-	Last Reset Time	

* Depends on the selected language (English by default).

** The information in this table, based on estimates, is indicative and can not be used as an real energy meter.

*** The powers and energies take account only power of compressors and fans.













Software Options – OPT_STA

	Name	Status	Unit	Displayed text*	Description
1	opt5	no/yes	-	OPT5: Medium Brine	Parameter set to "yes" means that Medium brine option which requires the Software Key is activated
2	opt6	no/yes	-	OPT6: Low Brine	Parameter set to "yes" means that Low brine option which requires the Software Key is activated
3	opt149	no/yes	-	OPT149: BACnet	Parameter set to "yes" means that BACnet option which requires the Software Key is activated
4	opt149B	no/yes	-	OPT149B: Modbus	Parameter set to "yes" means that Modbus option is activated

* Depends on the selected language (English by default).

7 - CONNECT TOUCH CONTROL: MENU STRUCTURE

7.2 Configuration menu (CONFIG)

Icon	Displayed text*	Description	Name
	General Configuration	General configuration	GENCONF
	Pump Configuration	Pump configuration	PUMPCONF
	Reset Configuration	Reset configuration	RESETCFG
	Backup Configuration	Backup configuration	BACKUP
	Schedule Menu	Schedule menu	SCHEDULE
	Holiday Menu	Holiday menu	HOLIDAY
	Date/Time Configuration	Date/time configuration	DATETIME
	Network Parameters	Network parameters (see section 7.3)	NETWORKS
	Control Identification	Control identification	CTRL_ID
	Add Options	Add Options	ADD_OPT

* Depends on the selected language (English by default).

** The Trendings menu is displayed in form of a graph; hence, it is not included in this section of the document (see section 5.10).

CAUTION

Since specific units may not include additional features, some tables may contain parameters that are not relevant and cannot be configured for a given unit.

7 - CONNECT TOUCH CONTROL: MENU STRUCTURE



General Configuration Menu – GENCONF

	Name	Status	Default	Unit	Displayed text*	Description
1	prio_cir	0 to 2	0	-	Cir Priority Sequence	Circuit priority
2					0=Auto, 1=A Prio	0 = Automatic circuit selection 1 = Circuit A priority
3					2=B Prio	2 = Circuit B priority
4	seq_typ	no/yes	no	-	Staged Loading Sequence	Staged loading sequence
5	ramp_sel	no/yes	no	-	Ramp Loading Select	Ramp loading selection
6	lim_sel	0 to 2	0	-	Demand Limit Type Select	Demand limit selection
7					0 = None	0 = None
8					1 = Switch Control	1 = Switch control
9					2 = 4-20mA Control	2 = 4-20 mA control
10	off_on_d	1 to 15	1	min	Unit Off to On Delay	Unit Off to On delay
11	heat_th	-11.96 to 0.14 10.4 to 32.0	-12.0 10.4	°C °F	Heating OAT Threshold	Heating OAT threshold
12	nh_start	-	-	-	Night Mode Start Hour	Night mode start hour
13	nh_end	-	-	-	Night Mode End Hour	Night mode end hour
14	nh_limit	0 to 100	100	%	Night Capacity Limit	Night capacity limit
15	ice_cnfg	no/yes	no	-	Ice Mode Enable	Ice mode enabled (Energy Management Module)
16	both_sel	no/yes	no	-	Both Command Sel (HSM)	Both command selection (HSM)
17	auto_sel	no/yes	no	-	Auto Changeover Select	Automatic changeover selection

* Depends on the selected language (English by default).



Pump Configuration Menu – PUMPCONF

	Name	Status	Default	Unit	Displayed text*	Description
1	pump_seq	0 to 4	1	-	Pumps Sequence	Pumps sequence
2					0 = No Pump	0 = No pump
3					1 = One Pump Only	1 = One pump only (units with one pump)
4					2 = Two Pumps Auto	2 = Two pumps automatic control
5					3 = Pump#1 Manual	3 = Pump 1 selected (units with two pumps)
6					4 = Pump#2 Manual	4 = Pump 2 selected (units with two pumps)
7	pump_del	24 to 3000	48	hour	Pump Auto Rotation Delay	Pump automatic rotation delay
8	pump_per	no/yes	no	-	Pump Sticking Protection	Pump sticking protection
9	pump_sby	no/yes	no	-	Stop Pump During Standby	Pump stops when the unit is in standby
10	pump_loc	no/yes	yes	-	Flow Checked If Pump Off	Flow checked if pump is off

* Depends on the selected language (English by default).

7 - CONNECT TOUCH CONTROL: MENU STRUCTURE



Reset Configuration Menu – RESETCFG

	Name	Status	Default	Unit	Displayed text*	Description
1	cr_sel	0 to 4	0	-	Cooling Reset Select	Cooling reset selection
2	hr_sel	0 to 4	0	-	Heating Reset Select	Heating reset selection
3					0=None, 1=OAT, 2=Delta T	0 = None, 1 = OAT, 2 = Delta T
4					3=4-20mA control	3 = 4-20 mA control
5					4=Space Temp	4 = Space temperature
6						
7					Cooling	Cooling
8	oat_crno	-9.94 to 52.22 14.0 to 125.0	-10.0 14.0	°C °F	OAT No Reset Value	OAT, no reset value
9	oat_crfu	-9.94 to 52.22 14.0 to 125.0	-10.0 14.0	°C °F	OAT Full Reset Value	OAT, max. reset value
10	dt_cr_no	0 to 14.0 0 to 25.0	0 0	°C °F	Delta T No Reset Value	Delta T, no reset value
11	dt_cr_fu	0 to 14.0 0 to 25.0	0 0	°C °F	Delta T Full Reset Value	Delta T, max. reset value
12	l_cr_no	0 to 20	0	mA	Current No Reset Value	Current, no reset value
13	l_cr_fu	0 to 20	0	mA	Current Full Reset Value	Current, max. reset value
14	spacr_no	-9.94 to 52.22 14.0 to 125.0	-10.0 14	°C °F	Space T No Reset Value	Space temperature, no reset value
15	spacr_fu	-9.94 to 52.22 14.0 to 125.0	-10.0 14	°C °F	Space T Full Reset Value	Space temperature, max. reset value
16	cr_deg	-16.80 to 16.80 -30.0 to 30.0	0 0	°C °F	Cooling Reset Deg. Value	Maximum cooling reset value
17						
18					Heating	Heating
19	oat_hrno	-9.94 to 52.22 14.0 to 125.0	-10.0 14.0	°C °F	OAT No Reset Value	OAT, no reset value
20	oat_hrfu	-9.94 to 52.22 14.0 to 125.0	-10.0 14.0	°C °F	OAT Full Reset Value	OAT, max. reset value
21	dt_hr_no	0 to 14.0 0 to 25.0	0 0	°C °F	Delta T No Reset Value	Delta T, no reset value
22	dt_hr_fu	0 to 14.0 0 to 25.0	0 0	°C °F	Delta T Full Reset Value	Delta T, max. reset value
23	l_hr_no	0 to 20	0	mA	Current No Reset Value	Current, no reset value
24	l_hr_fu	0 to 20	0	mA	Current Full Reset Value	Current, max. reset value
25	spahr_no	-9.94 to 52.22 14.0 to 125.0	-10.0 14.0	°C °F	Space T No Reset Value	Space temperature, no reset value
26	spahr_fu	-9.94 to 52.22 14.0 to 125.0	-10.0 14.0	°C °F	Space T Full Reset Value	Space temperature, max. reset value
27	hr_deg	-16.80 to 16.80 -30.0 to 30.0	0 0	°C °F	Heating Reset Deg. Value	Maximum heating reset value

* Depends on the selected language (English by default).



Backup Configuration Menu – BACKUP

	Name	Status	Default	Unit	Displayed text*	Description
1	boil_th	-14.98 to 15.26 5.0 to 59.0	-10.0 14.0	°C °F	Boiler OAT Threshold	Boiler OAT threshold
2	ehs_th	-4.90 to 21.42 23.0 to 70.0	5.0 41.0	°C °F	Elec Stage OAT Threshold	Electric heater stage OAT threshold
3	ehs_pull	0 to 60	0	min	Electrical Pulldown Time	Electrical pulldown time
4	ehs_back	no/yes	no	-	Last EHS for backup	Last electric heater stage for backup
5	ehs_defr	no/yes	no	-	Quick EHS for defrost	Quick EHS for defrost
6	ehs_kp	-20 to 20	2	-	EHS Proportional Gain	EHS proportional gain
7	ehs_ki	-5 to 5	0	-	EHS Integral Gain	EHS integral gain
8	ehs_kd	-20 to 20	0	-	EHS Derivative Gain	EHS derivative gain

* Depends on the selected language (English by default).

7 - CONNECT TOUCH CONTROL: MENU STRUCTURE



Schedule Menu – SCHEDULE

	Name	Displayed text*	Description
1	OCCPC01S	OCCPC01S - Schedule Menu	Unit on/off time schedule
2	OCCPC02S	OCCPC02S - Schedule Menu	Unit setpoint selection time schedule

* Depends on the selected language (English by default).



Holiday Menu – HOLIDAY

	Point name	Status	Unit	Displayed text*	Description
1	HOL_MON	0-12	0	Holiday Start Month	Holiday start month
2	HOL_DAY	0-31	0	Start Day	Holiday start day
3	HOL_LEN	0-99	0	Duration (days)	Holiday duration (days)

* Depends on the selected language (English by default).



Date/Time Configuration Menu – DATETIME

	Status	Displayed text*	Description
1	on/off	Daylight Saving Time	Information of setting the clocks forward one hour from standard time during the summer months, and back again in the fall, in order to make better use of natural daylight
2	Greenwich Mean Time (UTC)	Location	Time zone
3	YYYY/MM/DD, HH:MM:SS	Date/Time	Current date and time (must be set manually)
4	no/yes	Today is a Holiday	Information about holidays (read-only). Please note that holidays are set in the Holiday menu (see also section 7.2)
5	no/yes	Tomorrow is a Holiday	Information about the upcoming holiday period (read-only). Please note that holidays are set in the Holiday menu (see also section 7.2)

* Depends on the selected language (English by default).



Control Identification Menu – CTRL_ID

	Status	Default	Displayed text*	Description
1	0-239	1	Element Number	Element number
2	0-239	0	Bus Number	Bus number
3	9600 / 19200 / 38400	9600	Baud Rate	Communication speed
4	-	AQP ILD ST	Device Description	Unit description
5	-	-	Location Description	Location description: The number corresponds to the country
6	-	020-ST-20V4B100	Software Part Number	Software version
7	-	-	Serial Number	Serial number (MAC address)

* Depends on the selected language (English by default).







Add Options – ADD_OPT

	Displayed text*	Description
1	MAC address	Controller MAC address: This MAC address is requested by your Local CIAT service representative when ordering any software-protected option
2	Please Enter Your Software Activation Key:	Type the Software Activation Key provided by your Local CIAT service representative
3	Unit must be OFF	The unit should not be operating when installing the Software Activation Key

* Depends on the selected language (English by default).

7 - CONNECT TOUCH CONTROL: MENU STRUCTURE

7.3 Network Parameters menu

Icon	Displayed text*	Description	Name
	Email Configuration	Email configuration	EMAILCFG
	Modbus RTU Config.	Modbus RTU configuration	MODBUSRS
	Modbus TCP/IP Config	Modbus TCP/IP configuration	MODBUSIP
	BACnet Config.	BACnet Configuration	BACNET

* Depends on the selected language (English by default).



Email Configuration Menu – EMAILCFG

	Name	Status	Default	Unit	Displayed text*	Description
1	senderP1	"xx chars"			Sender Email Part1	Sender e-mail, identifier part
2					@	@
3	senderP2	"xx chars"			Sender Email Part2	Sender e-mail, domain part
4	recip1P1	"xx chars"			Recip1 Email Part1	Recipient 1, identifier part
5					@	@
6	recip1P2	"xx chars"			Recip1 Email Part2	Recipient 1, domain part
7	recip2P1	"xx chars"			Recip2 Email Part1	Recipient 2, identifier part
8					@	@
9	recip2P2	"xx chars"			Recip2 Email Part2	Recipient 2, domain part
10	smtpP1	0 to 255	0	-	SMTP IP Addr Part 1	SMTP IP address part 1
11	smtpP2	0 to 255	0	-	SMTP IP Addr Part 2	SMTP IP address part 2
12	smtpP3	0 to 255	0	-	SMTP IP Addr Part 3	SMTP IP address part 3
13	smtpP4	0 to 255	0	-	SMTP IP Addr Part 4	SMTP IP address part 4
14	accP1	-	-	-	Account Email Part1	Account e-mail, identifier part
15					@	@
16	accP2	-	-	-	Account Email Part2	Account e-mail, domain part
17	accPass	-	-	-	Account Password	Account password
18	portNbr	0 to 255	25	-	Port Number	Port number
19	srvTim	0 to 255	30	sec	Server Timeout	Server timeout
20	srvAut	0 to 1	0	-	Server Authentication	Server authentication

* Depends on the selected language (English by default).



Modbus RTU Config. Menu – MODBUSRS

	Name	Status	Default	Unit	Displayed text*	Description
1	modrt_en	no/yes	0	-	RTU Server Enable	RTU Server Enable
2	ser_UID	1 to 247	1	-	Server UID	Server UID
3	metric	no/yes	1	-	Metric Unit	Metric Unit
4	swap_b	0 to 1	0	-	Swap Bytes	Swap Bytes
5					0 = Big Endian	0 = Big Endian
6					1 = Little Endian	1 = Little Endian
7	baudrate	9600 to 38400	9600	-	Baudrate	Baudrate
8					0 = 9600	0 = 9600
9					1 = 19200	1 = 19200
10					2 = 38400	2 = 38400
11	parity	0 to 2	0	-	Parity	Parity
14					0 = No parity	0 = No parity
15					1 = Odd parity	1 = Odd parity
16					2 = Even parity	2 = Even parity
17	stop_bit	0 to 1	0	-	Stop bit number	Stop bit number
18					0 = One stop bit	0 = One stop bit
19					1 = Two stop bit	1 = Two stop bit

7 - CONNECT TOUCH CONTROL: MENU STRUCTURE



Modbus RTU Config. Menu – MODBUSRS (continued)

	Name	Status	Default	Unit	Displayed text*	Description
20	real_typ	0 to 1	1	-	Real Type Management	Real Type Management
21					0 = Float X10	0 = Float X10
22					1 = IEE 754	1 = IEE 754
23	reg32bit	0 to 1	1	-	Enable 32 bits registers	Enable 32 bits registers
24					0 = IR/HR in 16 bit mode	0 = IR/HR in 16 bit mode
25					1 = IR/HR in 32 bit mode	1 = IR/HR in 32 bit mode

* Depends on the selected language (English by default).



Modbus TCP/IP Config. Menu – MODBUSIP

	Name	Status	Default	Unit	Displayed text*	Description
1	modip_en	no/yes	no	-	TCP/IP Server Enable	TCP/IP Server Enable
2	ser_UID	1 to 247	1	-	Server UID	Server UID
3	port_nbr	0 to 65535	502	-	IP Port Number	IP Port Number
4	metric	no/yes	yes	-	Metric Unit	Metric Unit
5	swap_b	0 to 1	0	-	Swap Bytes	Swap Bytes
6					0 = Big Endian	0 = Big Endian
7					1 = Little Endian	1 = Little Endian
8	real_typ	0 to 1	1	-	Real Type Management	Real Type Management
9					0 = Float X10	0 = Float X10
10					1 = IEE 754	1 = IEE 754
11	reg32bit	0 to 1	1	-	Enable 32 bits registers	Enable 32 bits registers
12					0 = IR/HR in 16 bit mode	0 = IR/HR in 16 bit mode
13					1 = IR/HR in 32 bit mode	1 = IR/HR in 32 bit mode
14	conifnam	0 to 1	0	-	IP port interface name	IP port interface name
15					0 = J5/J15	0 = J5/J15
16					1 = J16	1 = J16
17	timeout	60 to 600	120	sec	Com. timeout (s)	Com. timeout (s)
18	idle	0 to 30	10	sec	Keepalive idle delay(s)	Keepalive idle delay(s)
19	intrvl	0 to 2	1	sec	Keepalive interval(s)	Keepalive interval(s)
20	probes	0 to 10	10	-	Keepalive probes nb	Keepalive probes nb

* Depends on the selected language (English by default).











BACnet Standard Conf. – BACNET

	Name	Status	Default	Unit	Displayed text*	Description
1	bacena	disable/enable	disable	-	BACnet Enable	BACnet Enable
2	bacunit	no/yes	yes	-	Metric Unit?	Metric Unit?
3	network	1 to 4000	1600	-	Network	Network
4	udpport	47808 to 47823	47808	-	UPD Port Number	UPD Port Number
5	bac_id	1 to 4194302	1600001	-	Device Id Manual	Device Id Manual
6	avid_opt	disable/enable	disable	-	Device Id Auto Option	Device Id Auto Option
7	balmena	disable/enable	enable	-	Alarm reporting	Alarm reporting
8	mng_occ	no/yes	no	-	BACnet Manage Occupancy	BACnet Manage Occupancy
9	conifnam	0 to 1	0	-	IP port Interface name	IP port Interface name
10					0 = J5/J15	0 = J5/J15
11					1 = J16	1 = J16

* Depends on the selected language (English by default).

7 - CONNECT TOUCH CONTROL: MENU STRUCTURE

7.4 System Menu

Icon	Displayed text*	Description	Name
	CPU Load	CPU Load Menu	CPULOAD
	EOL Resistor	EOL Resistor Menu	EOLRES
	Network	Network Menu	NETWORK
	Date/Time Configuration	Date/Time Configuration	DATETIME
	Language & Unit System	Language & Unit System Menu	LANGUNIT
	Brightness	Brightness	BRIGHTNS
	Software Info	Software Info Menu	SWINFO
	Hardware Info	Hardware Info Menu	HWINFO

* Depends on the selected language (English by default).



CPU Load Menu – CPULOAD

	Status	Default	Unit	Displayed text*	Description
1	0 to 100	-	%	CPU load	CPU utilization
2	0 to 100	-	%	RAM Memory utilization	RAM usage
3	0 to 100	-	%	FLASH Memory utilization	Flash memory usage

* Depends on the selected language (English by default).



EOL Resistor Menu – EOLRES

	Status	Default	Displayed text*	Description
1	disable/enable	disable	End of Line Res. J6(LEN)	End of line resistor J6 (LEN bus)
2	disable/enable	disable	End of Line Res. J7	End of line resistor J7
3	disable/enable	disable	End of Line Resistor J8	End of line resistor J8
4	disable/enable	disable	End of Line Resistor J10	End of line resistor J10 (Modbus)

* Depends on the selected language (English by default).



Network Menu – NETWORK

	Status	Default	Displayed text*	Description
1			IP Network Interface J5 (eth0):	IP Network Interface J5 (Ethernet 0):
2		xx:xx:xx:xx:xx:xx	MAC Address	MAC Address
3	-	169.254.1.1	TCP/IP Address	TCP/IP Address
4	-	255.255.255.0	Subnet Mask	Subnet Mask
5	-	169.254.1.3	Default Gateway	Default Gateway
6	-	255.255.0.0	Gateway Mask	Gateway Mask
7	-	169.254.1.3	Domain Name Server (DNS)	Domain Name Server (DNS)
8	-	169.254.1.4		

* Depends on the selected language (English by default).

7 - CONNECT TOUCH CONTROL: MENU STRUCTURE



Date/Time Configuration – DATETIME

	Status	Displayed text*	Description
1	on/off	Daylight Saving Time	Information of setting the clocks forward one hour from standard time during the summer months, and back again in the fall, in order to make better use of natural daylight
2	Greenwich Mean Time (UTC)	Location	Time zone
3	YYYY/MM/DD, HH:MM:SS	Date/Time	Current date and time (must be set manually)
4	no/yes	Today is a Holiday	Information about holidays (read-only). Please note that holidays are set in the Holiday menu (see also section 7.2)
5	no/yes	Tomorrow is a Holiday	Information about the upcoming holiday period (read-only). Please note that holidays are set in the Holiday menu (see also section 7.2)

* Depends on the selected language (English by default).

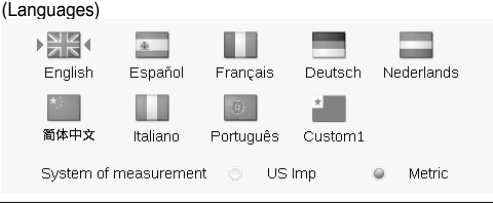

Language & Unit System Menu – LANGUNIT

Displayed text*	Description
<p>(Languages)</p> 	<p>Language list: English, Spanish, French, German, Dutch, Chinese, Italian, Portuguese, and Custom1</p> <p>Custom language: The control system allows users to add new languages to the control. To learn more about language customization, please contact your local CIAT service representative. Custom languages can be uploaded only by CIAT service representative.</p>
System of measurement: US Imp/Metric	<p>US Imp = Parameters displayed in US Imperial units Metric = Parameters displayed in metric units</p>

* Depends on the selected language (English by default).



Brightness Menu – BRIGHTNS

	Status	Displayed text*	Description
1	0 to 100%	Brightness	Screen brightness

* Depends on the selected language (English by default).



Software Info Menu – SWINFO

	Status	Displayed text*	Description
1	020-ST-20V4B100	Software Version	Software version number
2	N.NNN.N	SDK Version	SDK version number
3	NN	UI Version	User interface version
4	CIAT	Brand	Brand name

* Depends on the selected language (English by default).







Hardware Info Menu – HWINFO

	Status	Displayed text*	Description
1	-	Board Variant	Board variant
2	-	Board Revision	Board revision
3	43	Screen size	Screen size in inches

* Depends on the selected language (English by default).

7 - CONNECT TOUCH CONTROL: MENU STRUCTURE

7.5 Alarm Menu

Icon	Displayed text*	Description	Name
	Reset Alarms	Alarm reset	ALARMRST
	Current Alarms	Current alarms	CUR_ALM
	Alarm History	Alarms history	ALMHIST1
	Major Alarm History	Major alarms history	ALMHIST2

* Depends on the selected language (English by default).



Reset Alarms – ALARMRST

	Name	Date	Alarm text	Alarm text
1	RST_ALM	no/yes	Alarm Reset	Used to reset active alarms
2	ALM	-	Alarm State	Alarm state: Normal = No alarm Partial = There is an alarm, but the unit continues to operate Shutdown = Unit shuts down
3	alarm_1c	-	Current Alarm 1	Alarm code (see section 9.3)
4	alarm_2c	-	Current Alarm 2	Alarm code (see section 9.3)
5	alarm_3c	-	Current Alarm 3	Alarm code (see section 9.3)
6	alarm_4c	-	Current Alarm 4	Alarm code (see section 9.3)
7	alarm_5c	-	Current Alarm 5	Alarm code (see section 9.3)
8	alarm_1	-	Current Alarm 1 index	Alarm code (see section 9.3)
9	alarm_2	-	Current Alarm 2 index	Alarm code (see section 9.3)
10	alarm_3	-	Current Alarm 3 index	Alarm code (see section 9.3)
11	alarm_4	-	Current Alarm 4 index	Alarm code (see section 9.3)
12	alarm_5	-	Current Alarm 5 index	Alarm code (see section 9.3)

* Depends on the selected language (English by default).



Current Alarms – CUR_ALM

	Name	Date	Hour	Alarm text
1	Alarm	YYYY/MM/DD	HH:MM	Alarm text (see section 9.3)
...	Alarm	YYYY/MM/DD	HH:MM	Alarm text (see section 9.3)
10	Alarm	YYYY/MM/DD	HH:MM	Alarm text (see section 9.3)

* Depends on the selected language (English by default).



Alarm History – ALMHIST1

	Name	Date	Hour	Alarm text
1	Alarm	YYYY/MM/DD	HH:MM	Alarm text (see section 9.3)
...	Alarm	YYYY/MM/DD	HH:MM	Alarm text (see section 9.3)
50	Alarm	YYYY/MM/DD	HH:MM	Alarm text (see section 9.3)

* Depends on the selected language (English by default).



Reset Alarms – ALARMRST

	Name	Date	Hour	Alarm text
1	Alarm	YYYY/MM/DD	HH:MM	Alarm text (see section 9.3)
...	Alarm	YYYY/MM/DD	HH:MM	Alarm text (see section 9.3)
50	Alarm	YYYY/MM/DD	HH:MM	Alarm text (see section 9.3)

* Depends on the selected language (English by default).

8 - STANDARD CONTROL OPERATIONS AND OPTIONS

8.1 Unit Start / Stop control

The unit state is determined based on a number of factors, including its operating type, active overrides, open contacts, master/slave configuration, or alarms triggered due to operating conditions.

The table given below summarises the unit control type [ctrl_typ] and its running status with regard to the following parameters:

- **Operating type:** This operating type is selected using the **Start/Stop** button on the user interface.
- **Start/stop force command [CHIL_S_S]:** Chiller start/stop force command can be used to control the chiller state in the Network mode.
 - **Command set to stop:** The unit is halted.
 - **Command set to start:** The unit runs in accordance with schedule 1.
- **Remote start/stop contact status [Onoff_sw]:** Start/Stop contact status can be used to control the chiller state in the Remote operating type.
- **Master control type [ms_ctrl]:** When the unit is the master unit in a two-chiller master/slave arrangement, the master unit may be set to be controlled locally, remotely or via network.
- **Start/stop schedule [chil_occ]:** Occupied or unoccupied status of the unit.
- **Network emergency stop command [EMSTOP]:** If activated, the unit shuts down regardless of the active operating type.
- **General alarm:** The unit shuts down due to failure.

Active operating type						Parameters status						Result	
LOFF	L-On	L-SC	Rem	Net	Mast	Start/Stop force command	Remote start/stop contact	Master control type	Start/stop time schedule	Network emergency shutdown	General alarm	Control type	Unit state
-	-	-	-	-	-	-	-	-	-	enabled	-	-	off
-	-	-	-	-	-	-	-	-	-	-	yes	-	off
active	-	-	-	-	-	-	-	-	-	-	-	local	off
-	-	active	-	-	-	-	-	-	unoccupied	-	-	local	off
-	-	-	active	-	-	-	open	-	-	-	-	remote	off
-	-	-	active	-	-	-	-	-	unoccupied	-	-	remote	off
-	-	-	-	active	-	disabled	-	-	-	-	-	network	off
-	-	-	-	active	-	-	-	-	unoccupied	-	-	network	off
-	-	-	-	-	active	-	-	local	unoccupied	-	-	local	off
-	-	-	-	-	active	-	open	remote	-	-	-	remote	off
-	-	-	-	-	active	-	-	remote	unoccupied	-	-	remote	off
-	-	-	-	-	active	disabled	-	network	-	-	-	network	off
-	-	-	-	-	active	-	-	network	unoccupied	-	-	network	off
-	active	-	-	-	-	-	-	-	-	disabled	no	local	on
-	-	active	-	-	-	-	-	-	occupied	disabled	no	local	on
-	-	-	active	-	-	-	closed	-	occupied	disabled	no	remote	on
-	-	-	-	active	-	enabled	-	-	occupied	disabled	no	network	on
-	-	-	-	-	active	-	-	local	occupied	disabled	no	local	on
-	-	-	-	-	active	-	closed	remote	occupied	disabled	no	remote	on
-	-	-	-	-	active	enabled	-	network	occupied	disabled	no	network	on

IMPORTANT: When the unit is stopping or there is a demand to stop the unit, compressors are stopped consecutively. In case of emergency stop, all compressors are stopped at the same time.

8.2 Heating / Cooling control

AQUACIAT^{POWER} heat pumps and chillers fitted with a boiler may operate in cooling or heating mode. The CONNECT TOUCH control determines whether the unit is in the heating or cooling operating mode.

- Without a boiler, the chiller remains in Cooling mode (Heating is NOT possible).
- Heat pumps may operate in Cooling or Heating mode, depending on current configuration.

When the chiller is in **Heating mode**, the control utilises the boiler to satisfy the heating demand. For heat pumps, the boiler is used when mechanical heating is impossible or insufficient. Additionally, when the outside air temperature is very low, electric heaters can be used as a form of supplemental heating (heat pumps only).

When **Cooling mode** is selected, the unit will operate in the Cooling mode and, as a result, the boiler or electric heating will not be activated.

The unit may also "operate" in Standby mode which means that it is neither cooling nor heating. If the unit is in **Standby mode**, it does not cool or heat and compressors are stopped. The pump is running with no mechanical cooling or heating unless configured otherwise. The pump may be stopped depending on pumps configuration (PUMPCONF – Pump Configuration).



8 - STANDARD CONTROL OPERATIONS AND OPTIONS

8.2.1 Operating mode - control

The operating mode, i.e. cooling or heating, is determined based on the following parameters:

- **Unit on/off status [status]:** Unit running status.
- **Control type [ctrl_typ]:** Local, Remote or Network.
- **Local heat/cool selection [hc_sel]:** Heat/Cool selection when the unit is running in Local mode.
- **Remote heat/cool selection [onsw_cr]:** Heat/Cool selection when the unit is running in Remote mode.
- **Network heat/cool selection [HC_SEL]:** Heat/Cool selection when the unit is running in Network mode.
- **Outdoor air temperature [OAT]:** Heat/Cool setpoint selection when the automatic changeover has been enabled.

On/Off status	Control type	Heating/Cooling selection in local mode	Heating/Cooling contact in local mode	Heat/Cool select	Operating mode
off	-	-	-	-	cooling
on	local	cooling	-	-	cooling
on	local	heating	-	-	heating
on	remote	-	on cooling	-	cooling
on	remote	-	on heating	-	heating
on	network	-	-	cooling	cooling
on	network	-	-	heating	heating

8.2.2 Heating / Cooling selection

Heating/Cooling selection applies to chillers with a boiler and heat pumps. Heating/Cooling selection can be controlled in various ways, depending on the active operating type. By default, the cooling mode is selected.

Heating/Cooling selection can be determined:

- Locally at the unit using the HC_SEL item in the GENUNIT menu.
- Remotely via the heating/cooling selection contact, if the unit is in the Remote mode.
- Via a network command if the unit is in the Network mode.

Heating/Cooling mode can be set manually by the user or automatically by the control. When heating/cooling is automatic, the outdoor air temperature (OAT) determines the heat/cool/standby changeover (see the SETPOINT menu for cooling and heating mode changeover thresholds). The automatic changeover is optional and requires user configuration (GENUNIT – General Parameters).

8.3 Supplementary heating

AQUACIAT^{POWER} LD chillers may be fitted with a boiler that allows the unit to run in heating mode if required. The boiler is active only when the unit is in Heating mode.

AQUACIAT^{POWER} ILD heat pumps may be fitted with a boiler or electric heaters which are used as heating replacement when mechanical heating is not possible due to low outdoor air temperature. Electric heating can be turned on to satisfy the heating demand when mechanical heating is insufficient.

8.3.1 Boiler control

Boiler is activated when the outside air temperature is below the user-configured boiler outdoor temperature threshold which is by default set to -10°C (Boiler OAT Threshold in the BACKUP menu).

8.3.2 Electric heating control

Electric heating stages can be activated as additional heating when OAT is below the user-configured electric heating OAT threshold which is by default set to 5°C (Elec Stage OAT Threshold in the BACKUP menu).

Electric heating is allowed when:

- Unit is running at 100% capacity.
- Electric pull-down time elapsed.
- OAT is below the OAT threshold.

IMPORTANT: Please note that electric heating is not allowed when the demand limit is active on the unit.

8.4 Water pumps control

The CONNECT TOUCH control can manage one or two water exchanger pumps, determining the state of each pump as well as its speed. The pump can be turned on when configured and when the unit is running (Pumps Sequence in the PUMPCONF menu).

The pump is turned off when the unit is shut down due to an alarm, unless the fault is a frost protection error. The pump can be started in particular operating conditions when the water exchanger heater is active.

If the pump has failed and another pump is available, the unit is stopped and started again with the second pump. If there is no pump available, the unit shuts down.

Please remember that the configuration of pump(s) may differ depending on the number and type of pumps that are available for the specific unit (1 or 2 pumps / single-speed or variable-speed pumps).

8.4.1 Variable speed pumps control

AQUACIAT^{POWER} LD -ST/-HE chillers as well as ILD -ST/-HE heat pumps may be fitted with one or two variable speed pumps.

Variable speed pumps give the possibility of saving the pumping energy cost, providing precise water flow control and improving the overall performance of the system. The frequency inverter continuously regulates the flow rate to minimise the pump power consumption at full load and part load.

8 - STANDARD CONTROL OPERATIONS AND OPTIONS

Water flow management methods are as follows:

- 1) Fixed speed control (the control ensures a constant pump speed based on compressor capacity).
- 2) Water flow control based on constant water delta pressure (the control continuously acts on the pump speed to ensure a constant delta pressure).
- 3) Water flow control based on constant delta T on the water exchanger.

Fixed speed pumps can be either low or high pressure, whereas variable speed pumps are always high pressure pumps.

8.4.2 Configuring pumps

The CONNECT TOUCH can control fixed speed and variable speed pumps as well as customer pumps. Note that variable speed pumps can be configured as fixed speed pumps.

Basic pump configuration can be performed via the Configuration menu (PUMPCONF – Pump Configuration). Remember that only logged-in users may access the menu. The unit must be stopped.

IMPORTANT: Please note that the speed of the pump can be configured only by service technicians.

To set pumps sequence

1. Navigate to the Configuration menu (logged-in users only).
2. Select **Pump Configuration** (PUMPCONF).
3. Set Pumps Sequence [pump_seq].

Pumps Sequence [pump_seq]	
0	No pump
1	One pump only
2	Two pumps auto
3	Pump#1 Manual
4	Pump#2 Manual

8.4.3 Setting pumps automatically

If there are two pumps in the system controlled by the CONNECT TOUCH control, then the "pump reversing" functionality can be used. When the pump reversing option is selected, then the control balances the pump run time to match the configured pump changeover delay. In case the delay has elapsed, the pump reversing function is activated.

To set pumps automatic rotation delay

1. Navigate to the Configuration menu (logged-in users only).
2. Select **Pump Configuration** (PUMPCONF).
3. Set Pump Auto Rotation Delay [pump_del].

Pump Auto Rotation Delay [pump_del]	
24 to 3000h	48h

8.4.4 Setting customer pumps

Units with customer pumps are fitted with the flow switch, allowing for the water flow control.

Customer pumps have the following configurations possible:

Pump(s) available	[pump_seq]	Description
No pump	0	No pump
One single speed pump	1	One pump only
Two single speed pumps	2	Two pumps automatic
	3	Pump #1 manual
	4	Pump #2 manual

8.4.5 Setting pump protections

To mitigate the risk of freezing the water exchanger when the outside air temperature is low, the CONNECT TOUCH control provides a means to automatically start the pump each day at 14:00 for 2 seconds when the unit is "Off" (especially useful when the unit is stopped for a long time, e.g. during the winter season).

For units fitted with two pumps, the first pump is started on even days and the second pump is started on odd days. Starting the pump periodically for a few seconds extends the lifetime of the pump bearings and the tightness of the pump seal. This periodical pump quick start can be selected via the Configuration menu.

To set periodical pump quick start

1. Navigate to the Configuration menu (logged-in users only).
2. Select **Pump Configuration** (PUMPCONF).
3. Set Pump Sticking Protection [pump_per].

Pump Sticking Protection [pump_per]	
No/Yes	Yes

8.4.6 Setting ECO pump mode

When the unit is in Standby mode (heating or cooling demand is satisfied), the CONNECT TOUCH control may be configured to stop the pump periodically in order to save energy.

This option can be configured only by service technicians.

To verify the Eco Pump configuration

1. Navigate to the Main menu.
2. Select **Miscellaneous Status** (MSC_STAT).
3. Verify Eco Pump Mode Active [m_ecopmp].

Eco Pump Mode Active [m_ecopmp]	
No/Yes	

8.5 Hydronic kit option

The hydronic kit option allows for continuous monitoring of the water flow rate.

The hydronic kit provides the option to measure the following parameters:

- Inlet and Outlet water pressure.
- Water exchanger flow rate.

How is the water flow rate measured?

The water flow rate measurement is based on the calculation that takes into account the pressure difference between the Inlet water pressure and the Outlet water pressure as well as the pressure drop curves.

Hydronic kit option + variable speed pumps

In the case of units fitted with variable speed pumps, the CONNECT TOUCH control adjusts the pump speed automatically in order to make sure that the water flow rate is maintained at the correct level.

Depending on the selected configuration, the water flow control can be based on compressor usage, constant delta pressure or constant temperature difference.

8 - STANDARD CONTROL OPERATIONS AND OPTIONS

8.6 Control point

The control point represents the water temperature that the unit must produce. The required capacity can be decreased depending on the unit load operating conditions.

Control point = Active setpoint + Reset

The control point is based on the active setpoint and the reset calculation. The forced value can be used instead of any other setpoint calculation only when the unit is in the Network operating type.

8.6.1 Active setpoint

Two heating setpoints and three cooling setpoints can be selected. The third cooling setpoint is used for ice storage during unoccupied periods.

Depending on the current operation type, the active setpoint can be selected using one of the following methods:

- Manually
 - Via the Main menu (GENUNIT - General Parameters)
 - With the volt-free user contacts
 - Network commands
- Automatically
 - Setpoint Time Schedule is used (schedule 2)

The following tables provide the overview of possible setpoint selections, where the selected setpoint depends on the following parameters:

- **Control operating type:** Local, Remote, Network
- **Mode:** Cooling or Heating
- **Setpoint select parameter:** The Setpoint Select parameter in the General Parameters menu allows the user to select the active setpoint when operating in the Local control operating type [hc_sel in GENUNIT menu]
- **Ice configuration:** Ice production mode configuration [ice_cnfg in GENCONF menu]
- **Ice done contact status:** Available on EMM SIOB board
- **Setpoint switch status:** Remote Setpoint switch parameter in the Inputs menu
- **Schedule 2 status:** Schedule configuration

LOCAL OPERATING TYPE						
Mode	Setpoint selection	Ice configuration	Ice done contact	Setpoint switch	Schedule 2 status	Active setpoint
cooling	sp-1	-	*	*	-	Cooling setpoint 1
cooling	sp-2	-	*	*	-	Cooling setpoint 2
cooling	(*)	enable	open	closed	-	Ice setpoint
cooling	(*)	enable	closed	closed	-	Cooling setpoint 2
cooling	auto	-	*	*	occupied	Cooling setpoint 1
cooling	auto	-	*	*	unoccupied	Cooling setpoint 2
cooling	auto	enable	open	*	unoccupied	Ice setpoint
cooling	auto	enable	closed	*	unoccupied	Cooling setpoint 2
heating	sp-1	-	*	*	-	Heating setpoint 1
heating	sp-2	-	*	*	-	Heating setpoint 2
heating	auto	-	*	*	occupied	Heating setpoint 1
heating	auto	-	*	*	unoccupied	Heating setpoint 2

REMOTE OPERATING TYPE						
Mode	Setpoint selection	Ice configuration	Ice done contact	Setpoint switch	Schedule 2 status	Active setpoint
cooling	-	-	*	open	-	Cooling setpoint 1
cooling	-	-	*	closed	-	Cooling setpoint 2
cooling	-	enable	open	closed	-	Ice setpoint
cooling	-	enable	closed	closed	-	Cooling setpoint 2
heating	-	-	*	open	-	Heating setpoint 1
heating	-	-	*	closed	-	Heating setpoint 2

NETWORK OPERATING TYPE						
Mode	Setpoint selection	Ice configuration	Ice done contact	Setpoint switch	Schedule 2 status	Active setpoint
cooling	-	-	*	*	occupied	Cooling setpoint 1
cooling	-	-	*	*	unoccupied	Cooling setpoint 2
heating	-	-	*	*	occupied	Heating setpoint 1
heating	-	-	*	*	unoccupied	Heating setpoint 2

- * any configuration
- default configuration

8 - STANDARD CONTROL OPERATIONS AND OPTIONS

8.6.2 Reset calculation

Reset means that the active setpoint is modified so that less machine capacity is required in order to satisfy the current demand.

In the cooling mode the setpoint is increased, whereas in the heating mode it is usually decreased.

The reset can be based on the following factors (sources):

- OAT that gives the measure of the load trends for the building.
- Return water temperature (ΔT provides the average building load).
- Space temperature (Energy Management Module).
- Dedicated 4-20 mA input (Energy Management Module).

The reset source as well as reset parameters can be configured via the CONNECT TOUCH user interface (RESETCFG – Reset Configuration).

In response to a drop in the reset source, e.g. OAT, the cooling setpoint is normally reset upwards to optimise the unit performance.

The reset value is determined by linear interpolation based on the following parameters:

- A reference at which the reset is zero = no reset value
- A reference at which the reset is maximum = full reset value
- The maximum reset value

Reset example in Cooling mode:

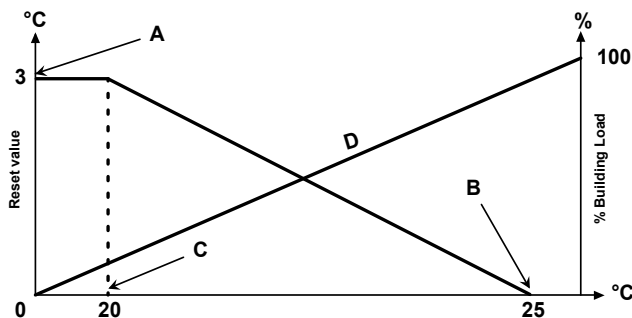

20	Reset based on OAT	25
0	Reset based on delta T	3
4	Reset based on analog input	20
no_reset	Selection	full_reset

Legend:

- A: Maximum reset value
- B: Reference for zero reset
- C: Reference for maximum reset
- D: Building load

8.7 Capacity limitation

The CONNECT TOUCH control allows for the constant control of the unit capacity. It is possible thanks to setting the unit's maximum allowable capacity.

How to understand "capacity limitation"?

Capacity limitation is used to determine the maximum unit's capacity. Capacity limitation is expressed in percentage, where a limit value of 100% means that the unit may run with its full capacity (no limitation is required).

The unit capacity can be limited as follows:

- By means of user-controlled volt-free contacts. The unit capacity can never exceed the setpoint limit activated by these contacts.
- By lag limit [LAG_LIM] set by the Master unit in the master/slave assembly. If the unit is not in the master/slave assembly, then the lag limit value is equal to 100%.
- By night mode limitation control. The demand limit value in the night mode is selectable if the value is below the selected capacity limit.

To set limit setpoints

1. Navigate to the Main menu.
2. Select **Setpoint Configuration** (SETPOINT).
3. Set Switch Limit Setpoint 1 / 2 / 3 [lim_sp1 / 2 / 3].

Switch Limit Setpoint 1 / 2 / 3 [lim_sp1 / 2 / 3]

0 to 100% 100%

To verify lag limit set by the master unit

1. Navigate to the Main menu.
2. Select **General Parameters** (GENUNIT).
3. Verify Lag Capacity Limit Value [LAG_LIM].

Lag Capacity Limit Value [LAG_LIM]

0 to 100% 100%

To set the night mode limit

1. Navigate to the Configuration menu (logged-in users only).
2. Select **General Configuration** (GENCONF).
3. Set Night Capacity Limit [nh_limit].

Night Capacity Limit [nh_limit]

0 to 100% 100%

Active demand limit

Based on the limit source, the active demand limit value [DEM_LIM] is set to the lowest possible value. The DEM_LIM parameter can be forced by Network.

To verify active demand limit value

1. Navigate to the Main menu.
2. Select **General Parameters** (GENUNIT).
3. Verify Active Demand Limit Val [DEM_LIM].

Active Demand Limit Val [DEM_LIM]

0 to 100% -

8 - STANDARD CONTROL OPERATIONS AND OPTIONS

8.8 Controlling capacity

The control adjusts the capacity to keep the water exchanger temperature at its setpoint. Compressors are started and stopped in a sequence designed to equalize the number of starts (value weighted by their operating type).

8.8.1 Circuit loading sequence

The function determines in which order the circuit capacity is changed. Compressor loading is managed by starting/stopping compressors. Two types of sequencing, i.e. balanced and staged loading sequence, are available and can be configured by the user via the user interface.

Balanced loading sequence: The control maintains equal capacity between all circuits as the machine loads and unloads. Balanced loading sequence is the default sequence employed by the control.

Staged loading sequence: The control loads the lead circuit completely before the lag circuit is started. When the load is decreasing, the lag circuit is unloaded first. Staged loading sequence is active when one of the circuits is shut down due to its failure; the circuit is in capacity override mode; or the remaining circuits are shut down or fully charged.

To set the circuit loading sequence

1. Navigate to the Configuration menu (logged-in users only).
2. Select **General Configuration** (GENCONF).
3. Set Staged Loading Sequence [seq_typ].

Staged Loading Sequence [seq_typ]	
No/Yes	No (staged loading NOT active)

8.8.2 Capacity for multi-circuit units

For units with more than one circuit, the lead/lag function determines which circuit is the lead circuit and which circuit is the lag circuit. This function controls the start/stop sequence of two refrigeration circuits called circuit A and circuit B.

The circuit authorised to start first is the lead circuit. Lead circuit is used first for capacity increases and at the same time should be decreased first when decreasing capacity. The lead/lag circuits can be selected manually or automatically.

- **Manual lead/lag circuit determination:** Circuit A or circuit B selected as the lead circuit. The selected circuit takes priority over another circuit.
- **Automatic lead/lag circuit determination:** The control system determines the lead circuit to equalise the operating time of each circuit (value weighted by the number of start-ups of each circuit). As a result, the circuit with the lowest number of operating hours always starts first.

To set circuit priority (manual or automatic selection)

1. Navigate to the Configuration menu (logged-in users only).
2. Select **General Configuration** (GENCONF).
3. Set Cir Priority Sequence [prio_cir].

Cir Priority Sequence [prio_cir]	
0	Auto
1	Circuit A lead
2	Circuit B lead

8.9 Night mode

Night mode allows users to configure the unit to operate with specific parameters in a specific time period, e.g. at night.

If the night mode is set, then during the night period:

- The unit capacity is limited.
- In order to reduce the noise level, the number of fans allowed to operate is restricted (cooling mode only).

The night period is defined by a start time and an end time that are the same for each day of the week. The night mode settings as well as the maximum capacity value can be set by logged-in users only.

To set circuit priority

1. Navigate to the Configuration menu (logged-in users only).
2. Select **General Configuration** (GENCONF).
3. Set parameters corresponding to the night mode.

Night Mode Start Hour [nh_start]	
00:00 to 24:00	
Night Mode End Hour [nh_end]	
00:00 to 24:00	
Night Capacity Limit [nh_limit]	
0 to 100%	100%

8.10 Controlling the coil pressure

The coil pressure of each circuit is managed by four fans maximum. AQUACIAT^{POWER} LD-ST and ILD-ST units come with fixed speed fans only, whereas AQUACIAT^{POWER} LD-HE series and ILD-HE series units may be fitted with variable speed fans that provide higher part load efficiency and reduced noise level.

In cooling mode, the condensing pressure is controlled independently in each circuit based on the saturated condensing temperature. The control permanently adjusts its setpoint to guarantee optimal performance and ensure anti-short-cycle protection of the fans.

In heating mode, the evaporating pressure is controlled independently on each circuit based on the saturated suction temperature. The control permanently adjusts its setpoint to guarantee optimal performance, delay and limit frost accumulation on coils.

8 - STANDARD CONTROL OPERATIONS AND OPTIONS

8.11 Setting holidays

The control allows the user to define 16 holiday periods. Each holiday period is defined by three parameters, i.e. the month, the start day, and the duration of the holiday period.

During the holiday period, depending on periods defined as holidays, the controller will be either in occupied or unoccupied mode. Holiday periods can be modified by logged-in users only.

To modify holiday periods

1. Navigate to the Configuration menu (logged-in users only).
2. Select **Holiday Menu** (HOLIDAY).
3. Choose the holiday period, e.g. HOLDY_01.
4. Set Holiday Start Month [HOL_MON], Start Day [HOL_DAY], Duration (days) [HOL_LEN].

Holiday Start Month [HOL_MON]	
0-12	0
Start Day [HOL_DAY]	
0-31	0
Duration (days) [HOL_LEN]	
0-99	0

8.12 Dry cooler – free cooling option

AQUACIAT^{POWER} LD chillers and AQUACIAT^{POWER} ILD heat pumps may be fitted with a dry cooler that enables power consumption reduction which amounts to energy and cost savings.

The installation of a dry cooler allows for "free cooling" – a method of using low outdoor air temperature as an aid to chilling water that is later used in the air-conditioning system. The system is the most effective when the outdoor air temperature is below 0°C (32°F).

This "dry cooler free cooling" mode is enabled when the outside air temperature ("OAT Free Cooling") is below the water loop temperature and the service-configured threshold parameter.

NOTE: Dry cooler water loop temperature and free cooling OAT measured by the control are read-only values that can be verified in the DC Free Cooling Status menu (DCFC_STA).

The control distinguishes between two types of fan control for a dry cooler free cooling option, where the first one embraces the use of fan staging and the second one that includes the use of variable speed fan. Mixed configuration can also be used (fixed and variable-speed fan control at the same time).

Dry cooler free cooling is normally stopped when the outside air temperature ("OAT Free Cooling") is above the water loop temperature and the service-configured threshold parameter. However, if it turns out that the cooling power of the dry cooler is not enough in order to reach the cooling setpoint, then the mechanical cooling will be started (when FC capacity is at 100%, then mechanical cooling can be started).

8.13 Energy Management Module

The CONNECT TOUCH control may be interconnected with the Energy Management Module (EMM) used to control the level of energy consumption, providing users with information such as the current unit status, compressors operating status, etc.

8.14 Heat recovery option (desuperheater)

Heat recovery is a method of using energy that would normally leave the system in the form of the waste heat released into the air.

Thanks to the concept of heat recovery, AQUACIAT^{POWER} ILD heat pumps can produce hot water using the recycled heat. Such a solution does not only allow for decreasing the energy consumption expenses but it also proves to be environmentally friendly. By recovering heat from the cooling cycle, the CONNECT TOUCH control system can maximise the unit efficiency and provide a large amount of hot water to the building system.

AQUACIAT^{POWER} LD chillers and AQUACIAT^{POWER} ILD heat pumps may be fitted with a desuperheater that allows for better energy management by providing partial heat reclaim functionality.

Desuperheater (heat exchanger) is mounted between the compressor and air-cooled condenser. The desuperheater is used to extract the high pressure, high temperature heat from the refrigerant to "desuperheat" it to a lower pressure refrigerant. The heat that is obtained in this process can be used for warming the water (up to 80°C). Please note that the vapour that goes into the desuperheater is not fully condensed; therefore, the refrigerant is channelled to a separate heat exchanger ("condenser") where the condensing process occurs.

To set the minimum desuperheat temperature

1. Navigate to the Main menu.
2. Select **Setpoint Configuration** (SETPOINT).
3. Set Desuperheat Min SCT [min_sct].

Desuperheat Min SCT [min_sct]	
24 to 50°C	40°C
75 to 122°F	104°F

8 - STANDARD CONTROL OPERATIONS AND OPTIONS

8.15 Defrost cycle (heat pumps only)

When the outside air temperature is low and the ambient humidity is high, the probability of frost forming on the surface of the outdoor coil increases. The frost covering the outdoor coil may decrease the air flow across the coil and lead to lower performance of the unit. To remove the frost from the coil, the control initiates the defrost cycle when necessary (defrost mode acts as Cooling mode).

8.15.1 Standard defrost

During the defrost cycle, the circuit is forced into the cooling mode. The heat (energy) is extracted from the water circuit by using compressors and reversing the 4-way valve. The defrost cycle lasts until the end of defrost temperature is achieved.

8.15.2 Free defrost

Free defrost is used in order to eliminate a respectively small amount of frost that has formed on the surface of the coil. Contrary to the standard defrost session, in the case of the free defrost session the heat (energy) is absorbed from the air. When running the free defrost operation, fans are activated and all compressors are turned off. The free defrost is most efficient when current heating demand is below the heating capacity delivered by the unit and the outside air temperature is above 1°C.

IMPORTANT: In the case of a large amount of frost covering the coil, the standard defrost cycle will be started.

8.16 Master/Slave control

The CONNECT TOUCH control system optimises the management of two units linked by the proprietary protocol network.

The unit configured as the Master is a control point for the master/slave assembly. The Master unit can be controlled locally, remotely or by network commands, while the Slave unit remains in Network mode.

All control commands sent to the master/slave assembly (start/stop, setpoint selection, heating/cooling, operating mode, load shedding, etc.) are handled by the unit which is configured as the master. The commands are transmitted automatically to the slave unit. For example, if the master chiller is turned off while the master/slave function is active, then the slave unit will be stopped.

In the event of a communication failure (between the two units), each unit will return to an autonomous operating mode until the detected fault is cleared. If the Master unit is stopped due to a detected alarm, then the Slave unit is authorised to start.

IMPORTANT: Master/Slave assembly can be configured only by service technicians.

8.17 BACnet IP option

The BACnet IP communication protocol can be used to communicate with other controllers available in the same BMS.

NOTE: This option requires the Software Activation Key.

8.18 Brine options

AQUACIAT^{POWER} units offer a few different cooler fluid types, including standard water fluid as well as the optional brine fluid, i.e. medium brine (option 5) and low brine (option 6). The brine option is commonly used for low temperature applications.

NOTE: This option requires the Software Activation Key.

8.19 Refrigerant gas leak detection option

The control permits refrigerant leak detection. Two additional sensors that detect the refrigerant concentration in the air must be installed on the unit.

If one of these sensors detects an abnormal refrigerant level for more than one hour (timer set by service technicians), the alarm will be triggered, but the unit will continue to operate.

8 - STANDARD CONTROL OPERATIONS AND OPTIONS

8.20 Software Activation Key(s)

AQUACIAT^{POWER} units with CONNECT TOUCH offer some additional options which require Software Activation Keys:

- **Cooler fluid type:**
 - Medium brine (option 5)
 - Low brine (option 6)
- **BACnet communication** (option 149)

These software-protected options can be factory-installed or installed on-site by the service technician or the customer.

Each option requires an individual software activation key.

To obtain the Software Activation Key, please contact your local Carrier Service representative.

8.20.1 Software options

The list of available software activation keys can be verified via the Main menu.

To verify available software options

1. Go to the Main menu.
2. Select *Software Options* (OPT_STA).
The menu can be accessed when logged in at user access level.
 - If the status of the option is set to “yes”, it means that the Software Activation Key for this option is installed.

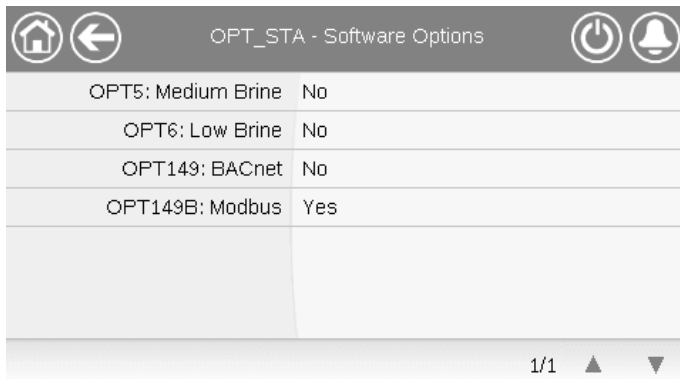

OPT_STA - Software Options	
OPT5: Medium Brine	No
OPT6: Low Brine	No
OPT149: BACnet	No
OPT149B: Modbus	Yes

IMPORTANT: In case the controller is replaced, the Software Activation Key must be installed again. See also section 8.20.2.

8.20.2 Replacement mode

To enable the use of software options until the Software Activation Key(s) is(are) installed, the Replacement mode will be activated.

- Software options will be unlocked for a limited period of time (7 days since the first start of the compressor).
- Only options that have been installed on the unit before will be active in the Replacement mode. Option status can be verified via the Main menu (OPT_STA – Software Options).
- Alarm 10122 will be triggered. If the Software Activation Key is not provided within 7 days since the first compressor start, the alarm will be reset automatically and software options will be blocked.
- The Replacement mode ends when the Software Activation Key is installed or the period of 7 days elapsed (7 days since the first compressor start).

8.20.3 Software key installation

To install the Software Activation Key via CONNECT TOUCH

1. Go to the Main menu.
2. Navigate to the Configuration menu (logged-in users only).
3. Select *Add Options* (ADD_OPT).
 - When installing the Software Activation Key, please make sure that the unit is stopped.

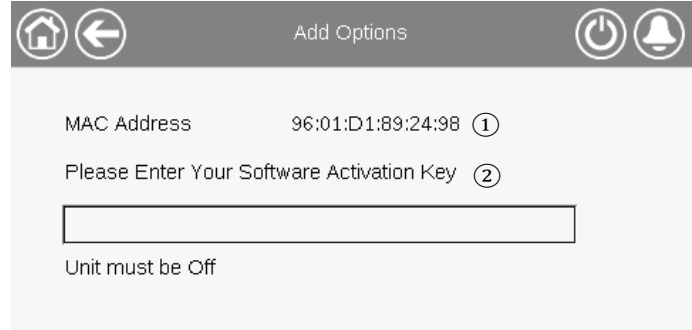

MAC Address 96:01:D1:89:24:98 ①

Please Enter Your Software Activation Key ②

Unit must be Off

Legend:

- ① Controller MAC address
- ② Software Activation Key

4. Enter the **Software Activation Key**.
 - If the Software Key ends with two equality signs (==), then these signs can be omitted. The Key will be accepted.
 - The Software Activation Key is case-sensitive.
5. Once the Software Activation Key is provided in the Keyboard screen, press **OK**.
6. Once the Software Activation Key is validated, the following message will be displayed: “**Software Activation Key Added**”.
7. The parameter connected with the activated functionality is set automatically and the control system will also be rebooted automatically.
 - If the Software Activation Key is incorrect, the following message will be displayed: “Software Activation Key is Invalid”.
 - If the Software Activation Key has been added before, the following message will be displayed: “Key Already Set”.

9 - DIAGNOSTICS

The control system has many fault tracing aid functions, protecting the unit against risks that could result in the failure of the unit.





9.1 Control diagnostics

The CONNECT TOUCH user interface enables the quick display of the unit status:

- The **blinking bell** icon indicates that there is an alarm, but the **unit is still running** (degraded mode).
- The **highlighted bell** icon indicates that the **unit is shut down** due to a detected fault.

The local interface – CONNECT TOUCH Control – gives the user quick access to monitor all unit operating conditions.

If an operating fault is detected, the alarm is triggered. All information regarding the existing alarms (current and past alarms) can be found in the Alarms menu.

Alarms menu	Access	Viewing alarm information			
		Date	Hour	Code	Description
Current Alarms 	Basic	✓	✓		✓
Reset Alarms 	User			✓	
Alarm History 	Basic	✓	✓		✓
Major Alarm History 	Basic	✓	✓		✓

9.1.1 Displaying current alarms

All currently active alarms can be found in the Current Alarms menu. In addition to the description of the alarm, the control provides information such as date or time that the alarm occurred.

- The Current alarms menu may display up to 10 current alarms.

To access the list of currently active alarms

1. Press the **Alarm** button in the upper-right part of the screen.
2. Select **Current Alarms**.
3. The list of active alarms will be displayed.

9.1.2 Resetting alarms

The alarm can be reset either automatically by the control or manually through the CONNECT TOUCH panel display or the web interface (in the Reset Alarms menu).

- The Reset alarms menu displays up to 5 alarm codes which are currently active on the unit.
- Alarms can be reset without stopping the machine.
- Only logged-in users can reset the alarms on the unit.

To reset the alarm manually

1. Press the **Alarm** button in the upper-right part of the screen.
2. Select **Reset Alarms**.
3. Set "Alarm Reset" to Yes.

IMPORTANT: Not all alarms can be reset by the user. Some alarms are reset automatically when operating conditions return to normal.

CAUTION

In the event of a power supply interrupt, the unit restarts automatically without the need for an external command. However, any faults active when the supply is interrupted are saved and may in certain cases prevent a circuit or a unit from restarting.

9.1.3 Reviewing alarm history

Information regarding resolved alarms can be accessed in the Alarm history menu which is divided into 50 recent alarms and 50 recent major alarms.

- **General alarms** are used to indicate pumps failure, transducers faults, network connection problems, etc.
- **Major alarms** are used to indicate process failure.

To access alarms history

1. Press the **Alarm** button in the upper-right part of the screen.
2. Select **Alarm History** or **Major Alarm History**.

9.2 E-mail notifications

The CONNECT TOUCH control system provides the option to define one or two recipients who receive e-mail notifications each time the new alarm occurs or all existing alarms have been reset.

- Only logged-in users can set and modify e-mail notifications.

To define e-mail recipients

1. Navigate to the Configuration menu and go to **Network Parameters**.
2. Select **Email Configuration**.
3. Add recipients who would receive notifications each time the alarm is triggered.

9 - DIAGNOSTICS

9.3 Alarms description

This section includes all alarms/alerts associated with the operation of the unit as well as optional drives used to provide variable speed fans and variable speed pumps functionalities.

9.3.1 General / Major alarms

The following table includes a list of alarms that might appear on the unit.

Code	Description	Possible cause	Action taken on the unit	Reset type
INPUTS FAILURES				
15001	Water Exchanger Entering Fluid Thermistor Failure	Defective thermistor or connection	Unit shuts down	Automatic, if thermistor reading returns to normal
15002	Water Exchanger Leaving Fluid Thermistor Failure	Defective thermistor or connection	Unit shuts down	Automatic, if thermistor reading returns to normal
15003	Circuit A Defrost Thermistor Failure	Defective thermistor or connection	Cooling / Standby mode: None Heating mode: Circuit A shuts down	Automatic, if thermistor reading returns to normal
15004	Circuit B Defrost Thermistor Failure	Defective thermistor or connection	Cooling / Standby mode: None Heating mode: Circuit B shuts down	Automatic, if thermistor reading returns to normal
15010	OAT Thermistor Failure	Defective thermistor or connection	Unit shuts down	Automatic, if thermistor reading returns to normal
15011	Master/Slave Common Leaving Fluid Thermistor	Defective thermistor or connection	Master/Slave control stopped and the unit returns to the standalone mode	Automatic, if thermistor reading returns to normal
15012	Circuit A Suction Gas Thermistor	Defective thermistor or connection	Circuit A shuts down	Automatic, if thermistor reading returns to normal
15013	Circuit B Suction Gas Thermistor	Defective thermistor or connection	Circuit B shuts down	Automatic, if thermistor reading returns to normal
15018	Circuit A Condenser Subcooling Liquid Thermistor Failure	Defective thermistor or connection	Unit returns to the air-cooled mode	Automatic, if thermistor reading returns to normal
15019	Circuit B Condenser Subcooling Liquid Thermistor Failure	Defective thermistor or connection	Unit returns to the air-cooled mode	Automatic, if thermistor reading returns to normal
15021	Space Temperature Thermistor	Defective thermistor or connection	Setpoint reset is cancelled / Unit continues to operate	Automatic, if thermistor reading returns to normal
15046	DC Free Cooling Water Loop Thermistor Failure	Defective thermistor or connection	Free cooling (dry cooler) mode is stopped	Automatic, if thermistor reading returns to normal
15047	DC Free Cooling Leaving Water Thermistor Failure	Defective thermistor or connection	Free cooling (dry cooler) mode is stopped	Automatic, if thermistor reading returns to normal
15048	DC Free Cooling OAT Thermistor Failure	Defective thermistor or connection	OAT thermistor reading is used instead of Dry Cooler OAT reading	Automatic, if thermistor reading returns to normal
PRESSURE TRANSDUCER FAILURES				
12001	Circuit A Discharge Transducer	Defective transducer or connection	Circuit A shuts down	Automatic, if sensor voltage reading returns to normal
12002	Circuit B Discharge Transducer	Defective transducer or connection	Circuit B shuts down	Automatic, if sensor voltage reading returns to normal
12004	Circuit A Suction Transducer	Defective transducer or connection	Circuit A shuts down	Automatic (up to 3 alarms within 24h); otherwise, Manual
12005	Circuit B Suction Transducer	Defective transducer or connection	Circuit B shuts down	Automatic (up to 3 alarms within 24h); otherwise, Manual
12007	Circuit A Reclaim Pumpdown Pressure Transducer	Not applicable	-	-
12008	Circuit B Reclaim Pumpdown Pressure Transducer	Not applicable	-	-
12024	Water Exchanger Entering Fluid Transducer Failure	Defective transducer or connection	Unit shuts down	Automatic, if sensor voltage reading returns to normal
12025	Water Exchanger Leaving Fluid Transducer Failure	Defective transducer or connection	Unit shuts down	Automatic, if sensor voltage reading returns to normal
COMMUNICATION FAILURES				
04901	Loss of communication with Circuit A SIOB board	Bus installation fault, communication error	Unit shuts down	Automatic, if communication is re-established
04902	Loss of communication with Circuit B SIOB Board	Bus installation fault, communication error	Unit shuts down	Automatic, if communication is re-established
04906	Loss of communication with Energy Management SIOB Board	Bus installation fault, communication error	None	Automatic, if communication is re-established
04501	Loss of communication with Fan Board Number 1	Bus installation fault, communication error	Unit shuts down	Automatic, if communication is re-established
04601	Loss of communication with DC Free Cooling Board	Bus installation fault, communication error	None	Automatic, if communication is re-established

9 - DIAGNOSTICS

Code	Description	Possible cause	Action taken on the unit	Reset type
04701	Loss of communication with VFD Fan Drive Board Circuit A	Bus installation fault, communication error	Circuit A shuts down	Automatic, if communication is re-established
04702	Loss of communication with VFD Fan Drive Board Circuit B	Bus installation fault, communication error	Circuit B shuts down	Automatic, if communication is re-established
04703	Loss of communication with VFD Pump Drive Board Number 1	Bus installation fault, communication error	Unit is stopped and restarted with the second pump (if available); If there is no pump available, the unit shuts down	Automatic, if communication is re-established
04704	Loss of communication with VFD Pump Drive Board Number 2	Bus installation fault, communication error	Unit is stopped and restarted with the second pump (if available); If there is no pump available, the unit shuts down	Automatic, if communication is re-established
PROCESS FAILURES				
10001	Water Exchanger Freeze Protection	No water flow, defective thermistor	Unit shuts down but the pump continues to run	Automatic (the first alarm in the last 24h); otherwise, Manual
10005	Circuit A Low Saturated Suction Temperature	Pressure transducer defective, EXV blocked or lack of refrigerant	Circuit A shuts down	Automatic (the first alarm in the last 24h); otherwise, Manual
10006	Circuit B Low Saturated Suction Temperature	Pressure transducer defective, EXV blocked or lack of refrigerant	Circuit B shuts down	Automatic (the first alarm in the last 24h); otherwise, Manual
10008	Circuit A High Superheat	Pressure transducer defective, temperature sensor defective, EXV blocked or lack of refrigerant	Circuit A shuts down	Manual
10009	Circuit B High Superheat	Pressure transducer defective, temperature sensor defective, EXV blocked or lack of refrigerant	Circuit B shuts down	Manual
10011	Circuit A Low Superheat	Pressure transducer defective, temperature sensor defective, EXV blocked or lack of refrigerant	Circuit A shuts down	Manual
10012	Circuit B Low Superheat	Pressure transducer defective, temperature sensor defective, EXV blocked or lack of refrigerant	Circuit B shuts down	Manual
10014	Customer Interlock Failure	Customer interlock input set "On"	Unit shuts down	Automatic (if the unit was stopped); otherwise, Manual
10016	Compressor A1 Not Started or Pressure Increase not established	Compressor breaker or fuse fault, compressor switch open	Compressor A1 shuts down	Manual
10017	Compressor A2 Not Started or Pressure Increase not established	Compressor breaker or fuse fault, compressor switch open	Compressor A2 shuts down	Manual
10018	Compressor A3 Not Started or Pressure Increase not established	Compressor breaker or fuse fault, compressor switch open	Compressor A3 shuts down	Manual
10019	Compressor A4 Not Started or Pressure Increase not established	Compressor breaker or fuse fault, compressor switch open	Compressor A4 shuts down	Manual
10020	Compressor B1 Not Started or Pressure Increase not established	Compressor breaker or fuse fault, compressor switch open	Compressor B1 shuts down	Manual
10021	Compressor B2 Not Started or Pressure Increase not established	Compressor breaker or fuse fault, compressor switch open	Compressor B2 shuts down	Manual
10022	Compressor B3 Not Started or Pressure Increase not established	Compressor breaker or fuse fault, compressor switch open	Compressor B3 shuts down	Manual
10023	Compressor B4 Not Started or Pressure Increase not established	Compressor breaker or fuse fault, compressor switch open	Compressor B4 shuts down	Manual
10028	Main Power Supply Fault	Power supply fault, high temperature in the electrical box	Unit shuts down and it is not allowed to start	Automatic, if the input is closed
10030	Master/Slave Communication Failure	Bus installation fault	Master/Slave control is stopped / Unit returns to the stand-alone mode	Automatic, if communication is restored
10031	Unit is in Network emergency stop	Network emergency stop command	Unit shuts down	Automatic, if emergency stop is deactivated
10032	Water Pump #1 Default	Flow switch or water pump fault	Unit is restarted with another pump running; If no pump is available, the unit shuts down	Manual
10033	Water Pump #2 Default	Flow switch or water pump fault	Unit is restarted with another pump running; If no pump is available, the unit shuts down	Manual

9 - DIAGNOSTICS

Code	Description	Possible cause	Action taken on the unit	Reset type
10037	Circuit A - Repeated High Discharge Gas Overrides	Repetitive capacity decreases	None OR circuit A shuts down	Automatic (no discharge gas overrides within 30 min) or Manual
10038	Circuit B - Repeated High Discharge Gas Overrides	Repetitive capacity decreases	None OR circuit B shuts down	Automatic (no discharge gas overrides within 30 min) or Manual
10040	Circuit A - Repeated Low Suction Temp Overrides	Repetitive capacity decreases	Circuit A shuts down	Manual
10041	Circuit B - Repeated Low Suction Temp Overrides	Repetitive capacity decreases	Circuit B shuts down	Manual
10043	Low Entering Water Temperature in Heating	Low entering fluid temperature in Heating mode	None	Automatic, if water temperature returns to normal or heating mode is stopped
10051	Water Exchanger Flow Switch Failure	Flow switch fault	Unit shuts down	Manual
10063	Circuit A High Pressure Switch Failure	High pressure switch is open, compressor fault	Circuit A shuts down	Manual
10064	Circuit B High Pressure Switch Failure	High pressure switch is open, compressor fault	Circuit B shuts down	Manual
10090	Water Exchanger Flow Switch: Setpoint Configuration Failure	Setpoint configuration failure	Unit cannot be started	Manual
10097	Water Exchanger Temperature Sensors Swapped	Input and output temperature reversed	Unit shuts down	Manual
10099	Refrigerant Leakage Detection	Refrigerant leak or leak detector defective	None	Automatic, if operating conditions return to normal
10101	DC Free Cooling Process Failure	Dry cooler fault	None	Automatic, if operating conditions return to normal
11202	Water Loop : Delta Pressure Error	Low water pressure offset	Pump is stopped and the unit cannot be started	Automatic, if water pressure delta returns to normal
11203	Water Loop : Pressure Too Low	Pump inlet pressure is below 60 kPa	Unit shuts down	Automatic (if water pressure reading returns to normal and the alarm occurred up to 6 times in the last 24h); otherwise, Manual
11204	Water Loop : Pump Not Started	Too low or high water pressure reading	Water pump is stopped	Automatic, if water pressure reading returns to normal
11206	Water Loop : Pump Overload	Water loop pressure drop too low	None	Automatic
11207	Water Loop : Flow Too Low	Water loop pressure drop too high	Water pump is stopped	Automatic, if water flow reading returns to normal
11208	Water Loop : Pressure Sensors Crossed	Pressure sensors crossed	Unit shuts down	Automatic (if the alarm occurred up to 6 occurrences in the last 24h); otherwise, Manual
11209	Water Loop : Low Pressure Warning	Low water pressure reading	None	Automatic, if water pressure reading returns to normal
10210	Low Delta Pressure Operation Failure - cir A	Circuit running in part load with all available compressors and low delta pressure during operation. Not enough capacity available / compressor fault	Circuit A shuts down	Manual
10211	Low Delta Pressure Operation Failure - cir B	Circuit running in part load with all available compressors and low delta pressure during operation. Not enough capacity available / compressor fault	Circuit B shuts down	Manual
SERVICE AND FACTORY				
70nn	Illegal configuration	Incorrect unit configuration	Unit cannot be started	Automatic, if configuration is corrected
8000	Initial factory configuration required	No factory configuration	Unit cannot be started	Automatic, if configuration is provided
90nn	Master Chiller Configuration Error Number #1 to nn	Configuration failure	Master/slave operation is disabled and the unit returns to the stand-alone mode	Automatic, if master/slave configuration returns to normal or the unit returns to the standalone mode

9 - DIAGNOSTICS

Code	Description	Possible cause	Action taken on the unit	Reset type
VFD DRIVE FAILURES AND WARNING				
130nn	Service Maintenance Alert Number # nn	Servicing action required. Contact Manufacturer Service Agency.	Depending on the severity of the alarm, the unit may continue to operate or the unit shuts down	Manual
130-	001: Circuit A Loss of charge 002: Circuit B Loss of charge 003: Water loop size warning 004: Maintenance servicing required 005: F-Gas Scheduled Check required	As above	As above	Manual
17001	Circuit A VFD Fan Drive Failure	Speed controller fault. See also 9.3.2 Drive alarms.	Circuit A shuts down	Automatic or Manual (motor overload only)
18001	Circuit B VFD Fan Drive Failure	Speed controller fault. See also 9.3.2 Drive alarms.	Circuit B shuts down	Automatic or Manual (motor overload only)
19001	VFD Pump 1 Drive Failure	Speed controller fault	Unit is restarted with another pump running. If no pumps are available, the unit shuts down	Automatic or Manual (motor overload only)
COMPRESSOR FAILURES				
6001	Circuit A Welded Contactor Failure	Welded contactor of a compressor	Unit shuts down, but the evaporator pump continues to operate	Manual (only after re-energization of unit)
6002	Circuit B Welded Contactor Failure	Welded contactor of a compressor	Unit shuts down, but the evaporator pump continues to operate	Manual (only after re-energization of unit)
1199	Compressor A1 Failure	Compressor fault	Compressor shuts down	Manual
1299	Compressor A2 Failure	Compressor fault	Compressor shuts down	Manual
1399	Compressor A3 Failure	Compressor fault	Compressor shuts down	Manual
1499	Compressor A4 Failure	Compressor fault	Compressor shuts down	Manual
2199	Compressor B1 Failure	Compressor fault	Compressor shuts down	Manual
2299	Compressor B2 Failure	Compressor fault	Compressor shuts down	Manual
2399	Compressor B3 Failure	Compressor fault	Compressor shuts down	Manual
2499	Compressor B4 Failure	Compressor fault	Compressor shuts down	Manual
SOFTWARE MODULE FAILURES				
55001	Database Module Failure	Software problem. Contact Manufacturer Service Agency.	Unit shuts down	Manual
56001	Lenscan Module Failure	Software problem. Contact Manufacturer Service Agency.	Unit shuts down	Manual
SIOB BOARD FAILURES				
57001	Circuit A SIOB Low Voltage Failure	Unstable electrical supply or electrical issue	Unit shuts down	Automatic (if voltage returns to normal and the alarm occurred up to 6 times in the last 24h); otherwise, Manual
57002	Circuit B SIOB Low Voltage Failure	Unstable electrical supply or electrical issue	Unit shuts down	Automatic (if voltage returns to normal and the alarm occurred up to 6 times in the last 24h); otherwise, Manual
57006	EMM SIOB Low Voltage Failure	Unstable electrical supply or electrical issue	Unit shuts down	Automatic (if voltage returns to normal and the alarm occurred up to 6 times in the last 24h); otherwise, Manual
57020	Main EXV stepper motor failure - cir A	EXV motor fault	Circuit A shuts down	Manual
57021	Main EXV stepper motor failure - cir B	EXV motor fault	Circuit B shuts down	Manual
57023	EXV eco stepper motor Failure - cir A	Manual	Circuit A shuts down	EXV motor fault
57024	EXV eco stepper motor Failure - cir B	Manual	Circuit B shuts down	EXV motor fault
COMMUNICATION FAILURES				
10029	Loss of Communication With System Manager	Communication error	Unit returns to the standalone mode	Automatic, if communication with System Manager is restored
REPLACEMENT MODE: SOFTWARE ACTIVATION KEY(S) MISSING				
10122	Replacement Mode: please contact CIAT service representative to activate options	Automatic, if Software Activation Key is installed Automatic, if Software Activation Key is not provided within 7 days since the first compressor start (the alarm will be reset and software-protected options will be blocked)	Replacement Mode: Please contact CIAT service representative to obtain activation key(s) to retrieve (or activate) software options	CONNECT TOUCH controller was replaced, but Software Activation Key is not installed

9 - DIAGNOSTICS

DRY COOLER FREE COOLING (DCFC) FAILURES				
15046	DC Free Cooling Water Loop Thermistor Failure	Automatic, if thermistor reading returns to normal	Dry cooler free cooling is disabled	Defective thermistor
15047	DC Free Cooling Leaving Water Thermistor Failure	As above	No action (alert)	As above
15048	DC Free Cooling OAT Sensor Failure	As above	Dry cooler free cooling is disabled	As above
4601	Loss of communication with DC Free Cooling Board	Automatic, if communication is re-established	Dry cooler free cooling is disabled	Bus installation fault, communication error
10101	DC Free Cooling Process Failure	Automatic, if OAT is above the service-configured threshold or DC free cooling capacity is below 100%	Dry cooler free cooling is disabled	Dry cooler free cooling inefficient
COMPRESSOR FAILURES				
10123	Wrong compressor Type configuration cir A	Manual (the first alarm within 24 hours); otherwise, Automatic	Circuit A shuts down	Check compressor configuration only one at every power cycle
10124	Wrong compressor Type configuration cir B	Manual (the first alarm within 24 hours); otherwise, Automatic	Circuit B shuts down	As above

NOTE: When the "action taken" given in the table above is defined as "none", it means that the alarm message is displayed, but no action is taken on the unit.

9 - DIAGNOSTICS

9.3.2 Drive alarms/alerts

Drive alarms or alerts for VFD drive failure are displayed based on the following formulas:

- $16000+X*1000+YYY$ for alarms
- $34000+X*1000+YYY$ for alerts

X stands for the drive number and YYY is the alarm/alert code.

Drive number	Drive assignment
1	Drive for fan(s) of circuit A
2	Drive for fan(s) of circuit B
3	Drive for water pump #1
4	Drive for water pump #2

The tables below present the most common alarms associated with Variable Frequency Drive (VFD) malfunction. Please refer to the applicable troubleshooting documentation for more information on other alarms.

Drives alarms

Code	Alarm/Alert	Description	Action to be taken
VFD alarms			
2	Alarm	Live zero fault	Contact Manufacturer Agency
4	Alarm	Mains phase loss	Check the VFD supply voltage and the phase balance ($\pm 3\%$)
7	Alarm	Overvoltage	Contact Manufacturer Agency
8	Alarm	Undervoltage	Contact Manufacturer Agency
9	Alarm	Inverter overloaded	Check the VFD output current
10	Alarm	Motor overtemperature	Check the motor temperature
11	Alarm	Motor thermistor	Contact Manufacturer Agency
12	Alarm	Torque limit exceeded	Check the VFD output current
13	Alarm	Overcurrent	Check the VFD output current
14	Alarm	Earth fault	Check if an earth fault exists
16	Alarm	Motor short-circuit	Check if there is a short-circuit at the VFD terminals
17	Alarm	Serial communication timeout	Check the connections and the shielding of the serial communication cable
23*	Alarm	Internal fan fault	Check the internal fan rotation
25	Alarm	Brake resistor short-circuited	Contact Manufacturer Agency
26	Alarm	Brake resistor Power limit	Contact Manufacturer Agency
28	Alarm	Brake verification	Contact Manufacturer Agency
29	Alarm	VFD temperature too high	Space temperature too high or VFD ventilation obstructed or damaged
30	Alarm	Motor phase U missing	Check wiring of phase U
31	Alarm	Motor phase V missing	Check wiring of phase V
32	Alarm	Motor phase W missing	Check wiring of phase W
33	Alarm	Inrush fault	Current demand too high: Let the VFD cool down for 20 minutes before starting it again
34	Alarm	Fieldbus communication fault	Check the connections and the shielding of the serial communication cable
36	Alarm	Mains failure	Check the VFD supply voltage and the phase balance ($\pm 3\%$)
38	Alarm	Internal fault	Contact Manufacturer Agency
47	Alarm	24 V supply low	Contact Manufacturer Agency
48	Alarm	1.8 V supply low	Contact Manufacturer Agency
57**	Alarm	AMA timeout	Contact Manufacturer Agency
65	Alarm	Control board overtemperature	Check the space temperature and the VFD fan
67	Alarm	Option configuration has changed	Contact Manufacturer Agency
68	Alarm	Emergency stop	Contact Manufacturer Agency
71	Alarm	PTC 1 emergency stop	Contact Manufacturer Agency
72	Alarm	Emergency stop	Contact Manufacturer Agency
80	Alarm	Drive initialized to default value	Contact Manufacturer Agency
94	Alarm	End of curve	Contact Manufacturer Agency
95	Alarm	Torque loss	Contact Manufacturer Agency
243	Alarm	IGBT defective	Contact Manufacturer Agency
251***	Alarm	New parts detached	Contact Manufacturer Agency

* Error 24 and 104 possible

** Error 50 to 58 possible

*** Error 70 or 250 possible

9 - DIAGNOSTICS

Drive alerts

Code	Alarm/Alert	Description	Action to be taken
VFD alerts			
1	Alert	10 V low	Contact Manufacturer Agency
2	Alert	Live zero error	Contact Manufacturer Agency
3	Alert	No motor	Check the motor connections
4	Alert	Mains phase loss	Check the VFD supply voltage and the phase balance ($\pm 3\%$)
5	Alert	DC link voltage high	Check the VFD supply voltage and the phase balance ($\pm 3\%$)
6	Alert	DC link voltage low	Check the VFD supply voltage and the phase balance ($\pm 3\%$)
7	Alert	DC overvoltage	Contact Manufacturer Agency
8	Alert	DC undervoltage	Contact Manufacturer Agency
9	Alert	Inverter overloaded	Check the VFD output current
10	Alert	Motor overtemperature	Check the motor temperature
11	Alert	Motor thermistor	Contact Manufacturer Agency
12	Alert	Torque limit exceeded	Check the VFD output current
13	Alert	Overcurrent	Check the VFD output current
14	Alert	Earth fault	Check if an earth fault exists
17	Alert	Control word timeout	Check the connections and the shielding of the serial communication cable
23*	Alert	Internal fan fault	Check the internal fan rotation
25	Alert	Brake resistor short-circuited	Contact Manufacturer Agency
26	Alert	Brake resistor Power limit	Contact Manufacturer Agency
28	Alert	Brake verification	Contact Manufacturer Agency
34	Alert	Fieldbus communication fault	Check the connections and the shielding of the serial communication cable
36	Alert	Mains failure	Check the VFD supply voltage and the phase balance ($\pm 3\%$)
47	Alert	24 V supply low	Contact Manufacturer Agency
49	Alert	Motor speed limit exceeded	Contact Manufacturer Agency
59	Alert	Current limit exceeded	Check the VFD output current
62	Alert	Output frequency at maximum limit	Check the VFD output current
64	Alert	Voltage limit	Supply voltage too low
65	Alert	Control board over temperature	Check the space temperature and the VFD fan
66	Alert	Heat sink temperature low	Space temperature too low
71	Alert	PTC1 emergency stop	Contact Manufacturer Agency
72	Alert	Emergency stop	Contact Manufacturer Agency
90†	Alert	Encoder loss	Contact Manufacturer Agency
94	Alert	End of curve	Contact Manufacturer Agency
95	Alert	Torque loss	Contact Manufacturer Agency
96	Alert	Start delayed	Contact Manufacturer Agency
97	Alert	Stop delayed	Contact Manufacturer Agency
98	Alert	Clock fault	Contact Manufacturer Agency
243	Alert	IGBT defective	Contact Manufacturer Agency
247	Alert	Capacity board temperature	Contact Manufacturer Agency

* Error 24 and 104 possible

† Not applicable to VFD size 102

10 - MAINTENANCE

In order to ensure the optimal operation of the equipment as well as the optimization of all the available functionalities, it is recommended to activate a Maintenance Contract with your local Service Agency.

The contract will ensure your equipment is regularly inspected by specialists so that any malfunction is detected and corrected quickly and no serious damage can occur to your equipment.

Your local Service Agency provides a wide range of service contracts which embrace the assistance of highly qualified HVAC engineering professionals ready to help if needed. The Maintenance contracts represent not only the best way to ensure the maximum operating life of your equipment, but also, through the expertise of qualified personnel, the optimal tool to manage your system in a cost-effective manner.

To find the best type of contract that will meet all of your expectations, please contact your local Manufacturer representatives.



Siège social

Avenue Jean Falconnier B.P. 14
01350 Culoz - France
Tel. : +33 (0)4 79 42 42 42
Fax : +33 (0)4 79 42 42 10
info@ciat.fr - www.ciat.com

Compagnie Industrielle
d'**A**pplications **T**hermiques
S.A. au capital de 26 728 480 €
R.C.S. Bourg-en-Bresse B 545.620.114



ISO9001 • ISO14001
OHSAS 18001



Avec Ecofolio
tous les papiers
se recyclent.