

SERVICE MANUAL

AIR-CONDITIONER (SPLIT TYPE)

INDOOR UNIT

<Compact 4-way Cassette type>

RAV-RM301MUT-E (TR)

RAV-RM401MUT-E (TR)

RAV-RM561MUT-E (TR)

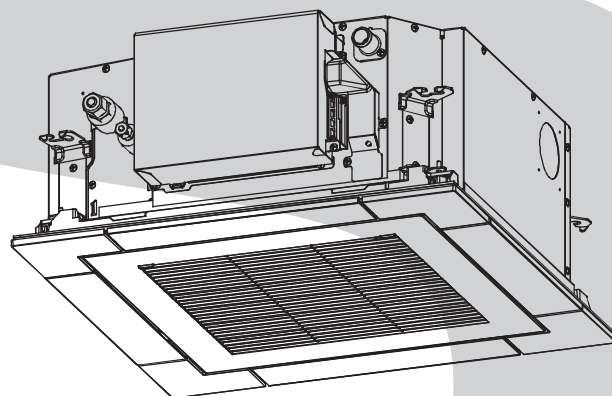

CONTENTS

Precaution for Safety	6
About refrigerant R32	14
About refrigerant R410A.....	17
1. SPECIFICATIONS	19
2. CONSTRUCTION VIEWS (EXTERNAL VIEWS)	23
2-1. RAV-RM301MUT*	23
2-2. RAV-RM401MUT*, RM561MUT*	24
3. WIRING DIAGRAMS	25
4. PARTS RATING	26
5. SYSTEMATIC REFRIGERATING CYCLE DIAGRAM	27
5-1. Indoor Unit.....	27
6. INDOOR CONTROL CIRCUIT	30
6-1. Indoor Controller Block Diagram	30
6-1-1. Connection of Wired (Simple) Remote Controller	30
6-1-2. Connection of Wireless Remote Controller Kit	31
6-1-3. Connection of Both Wired (Simple) Remote Controller and Wireless Remote Controller Kit	32
6-2. Control Specifications.....	33
6-3. Indoor Print Circuit Board	45
6-4. Optional connector specifications of indoor P.C. board	46
7. TROUBLESHOOTING	47
7-1. Summary of Troubleshooting	47
7-2. Troubleshooting	49
7-2-1. Outline of judgment	49
7-2-2. Others (Other than Check Code)	51
7-2-3. Check Code List (Indoor)	52
7-2-4. Diagnostic Procedure for Each Check Code (Indoor Unit)	55
8. REPLACEMENT OF SERVICE P.C. BOARD	69
8-1. Indoor Unit.....	69
9. SETUP AT LOCAL SITE AND OTHERS.....	74
9-1. Indoor Unit.....	74
9-1-1. Test Run Setup on Remote Controller	74
9-1-2. Forced Defrost Setup of Remote Controller (For wired remote controller only)	76
9-1-3. LED Display on P.C. Board	76
9-1-4. Function Selection Setup	77
9-1-5. Wiring and Setting of Remote Controller Control	80
9-1-6. Monitor Function of Remote Controller Switch	82
9-2. Setup at Local Site / Others	85
9-3. How to Set up Central Control Address Number	87
10. ADDRESS SETUP	88
10-1. Address Setup	88
10-2. Address Setup & Group Control	89
10-2-1. System configuration	89
10-2-2. Automatic Address Example from Unset Address (No miswiring)	91
10-3. Address Setup (Manual Setting from Remote Controller)	92
10-4. Confirmation of Indoor Unit No. Position	93
11. DETACHMENTS	95
12. EXPLODED VIEWS AND PARTS LIST	103
12-1. RAV-RM301MUT-E, RM401MUT-E, RM561MUT-E	103
12-2. RAV-RM301MUT-TR, RM401MUT-TR, RM561MUT-TR	105

Original instruction

Please read carefully through these instructions that contain important information which complies with the “Machinery” Directive (Directive 2006/42/EC), and ensure that you understand them.

Generic Denomination: Air Conditioner

Definition of Qualified Installer or Qualified Service Person

The air conditioner must be installed, maintained, repaired and removed by a qualified installer or qualified service person. When any of these jobs is to be done, ask a qualified installer or qualified service person to do them for you.

A qualified installer or qualified service person is an agent who has the qualifications and knowledge described in the table below.

Agent	Qualifications and knowledge which the agent must have
Qualified installer	<ul style="list-style-type: none"> • The qualified installer is a person who installs, maintains, relocates and removes the air conditioners made by Toshiba Carrier Corporation. He or she has been trained to install, maintain, relocate and remove the air conditioners made by Toshiba Carrier Corporation or, alternatively, he or she has been instructed in such operations by an individual or individuals who have been trained and is thus thoroughly acquainted with the knowledge related to these operations. • The qualified installer who is allowed to do the electrical work involved in installation, relocation and removal has the qualifications pertaining to this electrical work as stipulated by the local laws and regulations, and he or she is a person who has been trained in matters relating to electrical work on the air conditioners made by Toshiba Carrier Corporation or, alternatively, he or she has been instructed in such matters by an individual or individuals who have been trained and is thus thoroughly acquainted with the knowledge related to this work. • The qualified installer who is allowed to do the refrigerant handling and piping work involved in installation, relocation and removal has the qualifications pertaining to this refrigerant handling and piping work as stipulated by the local laws and regulations, and he or she is a person who has been trained in matters relating to refrigerant handling and piping work on the air conditioners made by Toshiba Carrier Corporation or, alternatively, he or she has been instructed in such matters by an individual or individuals who have been trained and is thus thoroughly acquainted with the knowledge related to this work. • The qualified installer who is allowed to work at heights has been trained in matters relating to working at heights with the air conditioners made by Toshiba Carrier Corporation or, alternatively, he or she has been instructed in such matters by an individual or individuals who have been trained and is thus thoroughly acquainted with the knowledge related to this work.
Qualified service person	<ul style="list-style-type: none"> • The qualified service person is a person who installs, repairs, maintains, relocates and removes the air conditioners made by Toshiba Carrier Corporation. He or she has been trained to install, repair, maintain, relocate and remove the air conditioners made by Toshiba Carrier Corporation or, alternatively, he or she has been instructed in such operations by an individual or individuals who have been trained and is thus thoroughly acquainted with the knowledge related to these operations. • The qualified service person who is allowed to do the electrical work involved in installation, repair, relocation and removal has the qualifications pertaining to this electrical work as stipulated by the local laws and regulations, and he or she is a person who has been trained in matters relating to electrical work on the air conditioners made by Toshiba Carrier Corporation or, alternatively, he or she has been instructed in such matters by an individual or individuals who have been trained and is thus thoroughly acquainted with the knowledge related to this work. • The qualified service person who is allowed to do the refrigerant handling and piping work involved in installation, repair, relocation and removal has the qualifications pertaining to this refrigerant handling and piping work as stipulated by the local laws and regulations, and he or she is a person who has been trained in matters relating to refrigerant handling and piping work on the air conditioners made by Toshiba Carrier Corporation or, alternatively, he or she has been instructed in such matters by an individual or individuals who have been trained and is thus thoroughly acquainted with the knowledge related to this work. • The qualified service person who is allowed to work at heights has been trained in matters relating to working at heights with the air conditioners made by Toshiba Carrier Corporation or, alternatively, he or she has been instructed in such matters by an individual or individuals who have been trained and is thus thoroughly acquainted with the knowledge related to this work.

Definition of Protective Gear

When the air conditioner is to be transported, installed, maintained, repaired or removed, wear protective gloves and 'safety' work clothing.

In addition to such normal protective gear, wear the protective gear described below when undertaking the special work detailed in the table below.



Failure to wear the proper protective gear is dangerous because you will be more susceptible to injury, burns, electric shocks and other injuries.

Work undertaken	Protective gear worn
All types of work	Protective gloves 'Safety' working clothing
Electrical-related work	Gloves to provide protection for electricians Insulating shoes Clothing to provide protection from electric shock
Work done at heights (50 cm or more)	Helmets for use in industry
Transportation of heavy objects	Shoes with additional protective toe cap
Repair of outdoor unit	Gloves to provide protection for electricians

The important contents concerned to the safety are described on the product itself and on this Service Manual.



Please read this Service Manual after understanding the described items thoroughly in the following contents (Indications / Illustrated marks), and keep them.

[Explanation of indications]

Indication	Explanation
 DANGER	Indicates contents assumed that an imminent danger causing a death or serious injury of the repair engineers and the third parties when an incorrect work has been executed.
 WARNING	Indicates possibilities assumed that a danger causing a death or serious injury of the repair engineers, the third parties, and the users due to troubles of the product after work when an incorrect work has been executed.
 CAUTION	Indicates contents assumed that an injury or property damage (*) may be caused on the repair engineers, the third parties, and the users due to troubles of the product after work when an incorrect work has been executed.

* Property damage: Enlarged damage concerned to property, furniture, and domestic animal / pet

[Explanation of illustrated marks]





Indication	Explanation
	Indicates prohibited items (Forbidden items to do) The sentences near an illustrated mark describe the concrete prohibited contents.
	Indicates mandatory items (Compulsory items to do) The sentences near an illustrated mark describe the concrete mandatory contents.
	Indicates cautions (Including danger / warning) The sentences or illustration near or in an illustrated mark describe the concrete cautious contents.

Warning Indications on the Air Conditioner Unit

[Confirmation of warning label on the main unit]

Confirm that labels are indicated on the specified positions



If removing the label during parts replace, stick it as the original.

Warning indication	Description		
 <table border="1" data-bbox="311 421 662 645"> <tr> <td data-bbox="311 421 662 504">WARNING</td> </tr> <tr> <td data-bbox="311 504 662 645"> ELECTRICAL SHOCK HAZARD Disconnect all remote electric power supplies before servicing. </td> </tr> </table>	WARNING	ELECTRICAL SHOCK HAZARD Disconnect all remote electric power supplies before servicing.	<p>WARNING</p> <p>ELECTRICAL SHOCK HAZARD Disconnect all remote electric power supplies before servicing.</p>
WARNING			
ELECTRICAL SHOCK HAZARD Disconnect all remote electric power supplies before servicing.			
 <table border="1" data-bbox="311 703 662 927"> <tr> <td data-bbox="311 703 662 786">WARNING</td> </tr> <tr> <td data-bbox="311 786 662 927"> Moving parts. Do not operate unit with grille removed. Stop the unit before the servicing. </td> </tr> </table>	WARNING	Moving parts. Do not operate unit with grille removed. Stop the unit before the servicing.	<p>WARNING</p> <p>Moving parts. Do not operate unit with grille removed. Stop the unit before the servicing.</p>
WARNING			
Moving parts. Do not operate unit with grille removed. Stop the unit before the servicing.			
 <table border="1" data-bbox="311 983 662 1207"> <tr> <td data-bbox="311 983 662 1066">CAUTION</td> </tr> <tr> <td data-bbox="311 1066 662 1207"> High temperature parts. You might get burned when removing this panel. </td> </tr> </table>	CAUTION	High temperature parts. You might get burned when removing this panel.	<p>CAUTION</p> <p>High temperature parts. You might get burned when removing this panel.</p>
CAUTION			
High temperature parts. You might get burned when removing this panel.			
 <table border="1" data-bbox="311 1265 662 1489"> <tr> <td data-bbox="311 1265 662 1348">CAUTION</td> </tr> <tr> <td data-bbox="311 1348 662 1489"> Do not touch the aluminum fins of the unit. Doing so may result in injury. </td> </tr> </table>	CAUTION	Do not touch the aluminum fins of the unit. Doing so may result in injury.	<p>CAUTION</p> <p>Do not touch the aluminium fins of the unit. Doing so may result in injury.</p>
CAUTION			
Do not touch the aluminum fins of the unit. Doing so may result in injury.			
 <table border="1" data-bbox="311 1547 662 1771"> <tr> <td data-bbox="311 1547 662 1630">CAUTION</td> </tr> <tr> <td data-bbox="311 1630 662 1771"> BURST HAZARD Open the service valves before the operation, otherwise there might be the burst. </td> </tr> </table>	CAUTION	BURST HAZARD Open the service valves before the operation, otherwise there might be the burst.	<p>CAUTION</p> <p>BURST HAZARD Open the service valves before the operation, otherwise there might be the burst.</p>
CAUTION			
BURST HAZARD Open the service valves before the operation, otherwise there might be the burst.			



Precaution for Safety







The appliance shall be installed in accordance with national wiring regulations. Capacity shortages of the power circuit or an incomplete installation may cause an electric shock or fire.





DANGER







 Check earth wires.	<p>Before carrying out the installation, maintenance, repair or removal work, be sure to set the circuit breaker to the OFF position. Otherwise, electric shocks may result.</p>
	<p>Before opening the intake grille of the indoor unit or service panel of the outdoor unit, set the circuit breaker to the OFF position. Failure to set the circuit breaker to the OFF position may result in electric shocks through contact with the interior parts. Only a qualified installer (*1) or qualified service person (*1) is allowed to remove the intake grille of the indoor unit or service panel of the outdoor unit and do the work required.</p>
	<p>Before opening the electric cover set the circuit breaker to the OFF position. Failure to set the circuit breaker to the OFF position may result in injury through contact with the rotation parts.</p>
	<p>When cleaning the filter or other parts of the indoor unit, set the circuit breaker to OFF without fail, and place a "Work in progress" sign near the circuit breaker before proceeding with the work.</p>
	<p>When you have noticed that some kind of trouble (such as when a check code display has appeared, there is a smell of burning, abnormal sounds are heard, the air conditioner fails to cool or heat or water is leaking) has occurred in the air conditioner, do not touch the air conditioner yourself but set the circuit breaker to the OFF position, and contact a qualified service person. Take steps to ensure that the power will not be turned on (by marking "out of service" near the circuit breaker, for instance) until qualified service person arrives. Continuing to use the air conditioner in the trouble status may cause mechanical problems to escalate or result in electric shocks or other failure.</p>
 Electric shock hazard.	<p>When checking the electric parts, removing the cover of the electric parts box of Indoor Unit and/or service panel of Outdoor Unit inevitably to determine the failure, use gloves to provide protection for electricians, insulating shoes, clothing to provide protection from electric shock and insulating tools. Be careful not to touch the live part. Electric shock may result. Only "Qualified service person" is allowed to do this work.</p>
 Prohibition	<p>Do not turn ON the circuit breaker under the condition of removing a cabinet, a panel, etc. Otherwise, it leads to an electric shock with a high voltage, resulting in loss of life.</p>





 **WARNING**

 General	<p>Before starting to repair the air conditioner, read carefully through the Service Manual, and repair the air conditioner by following its instructions.</p>
	<p>Only qualified service person (*1) is allowed to repair the air conditioner. Repair of the air conditioner by unqualified person may give rise to a fire, electric shocks, injury, water leaks and/or other problems.</p>
	<p>Only a qualified installer (*1) or qualified service person (*1) is allowed to carry out the electrical work of the air conditioner. Under no circumstances must this work be done by an unqualified individual since failure to carry out the work properly may result in electric shocks and/or electrical leaks.</p>
	<p>Wear protective gloves and safety work clothing during installation, servicing and removal.</p>
	<p>Do not use any refrigerant different from the one specified for complement or replacement. Otherwise, abnormally high pressure may be generated in the refrigeration cycle, which may result in a failure or explosion of the product or an injury to your body.</p>
	<p>When connecting the electrical wires, repairing the electrical parts or undertaking other electrical jobs, wear gloves to provide protection for electricians, insulating shoes and clothing to provide protection from electric shocks. Failure to wear this protective gear may result in electric shocks.</p>
	<p>When the air conditioner is to be transported, installed, maintained, repaired or removed, wear protective gloves and safety work clothing.</p>
	<p>To connect the electrical wires, repair the electrical parts or undertake other electrical jobs, wear gloves to provide protection for electricians, insulating shoes and clothing to provide protection from electric shocks. Failure to wear this protective gear may result in electric shocks.</p>
	<p>Electrical wiring work shall be conducted according to law and regulation in the community and installation manual. Failure to do so may result in electrocution or short circuit.</p>
	<p>Use wiring that meets the specifications in the Installation Manual and the stipulations in the local regulations and laws. Use of wiring which does not meet the specifications may give rise to electric shocks, electrical leakage, smoking and/or a fire.</p>
	<p>Only a qualified installer (*1) or qualified service person (*1) is allowed to undertake work at heights using a stand of 50 cm or more.</p>
	<p>When working at heights, use a ladder which complies with the ISO 14122 standard, and follow the procedure in the ladder fs instructions. Also wear a helmet for use in industry as protective gear to undertake the work.</p>
	<p>When working at heights, put a sign in place so that no-one will approach the work location, before proceeding with the work. Parts and other objects may fall from above, possibly injuring a person below.</p>
	<p>When executing address setting, test run, or troubleshooting through the checking window on the electric parts box, put on insulated gloves to provide protection from electric shock. Otherwise you may receive an electric shock.</p>
	<p>Do not touch the aluminum fin of the outdoor unit. You may injure yourself if you do so. If the fin must be touched for some reason, first put on protective gloves and safety work clothing, and then proceed.</p>
	<p>Do not climb onto or place objects on top of the outdoor unit. You may fall or the objects may fall off of the outdoor unit and result in injury.</p>
	<p>When transporting the air conditioner, wear shoes with additional protective toe caps.</p>
<p>When transporting the air conditioner, do not take hold of the bands around the packing carton. You may injure yourself if the bands should break.</p>	
<p>Be sure that a heavy unit (10 kg or heavier) such as a compressor is carried by four persons.</p>	
<p>This air conditioner has passed the pressure test as specified in IEC 60335-2-40 Annex EE.</p>	
 Electric shock hazard	<p>When you access inside of the electric cover to repair electric parts, wait for about five minutes after turning off the breaker. Do not start repairing immediately. Otherwise you may get electric shock by touching terminals of high-voltage capacitors. Natural discharge of the capacitor takes about five minutes.</p>
 Prohibition	<p>Place a "Work in progress" sign near the circuit breaker while the installation, maintenance, repair or removal work is being carried out. There is a danger of electric shocks if the circuit breaker is set to ON by mistake.</p>
	<p>When checking the electric parts, removing the cover of the electric parts box of Indoor Unit and/ or front panel of Outdoor Unit inevitably to determine the failure, put a sign "Do not enter" around the site before the work. Failure to do this may result in third person getting electric shock.</p>
	<p>Before operating the air conditioner after having completed the work, check that the electrical parts box cover of the indoor unit and service panel of the outdoor unit are closed, and set the circuit breaker to the ON position. You may receive an electric shock if the power is turned on without first conducting these checks.</p>



 Stay on protection	If, in the course of carrying out repairs, it becomes absolutely necessary to check out the electrical parts with the electrical parts box cover of one or more of the indoor units and the service panel of the outdoor unit removed in order to find out exactly where the trouble lies, wear insulated heat-resistant gloves, insulated boots and insulated work overalls, and take care to avoid touching any live parts. You may receive an electric shock if you fail to heed this warning. Only qualified service person (*1) is allowed to do this kind of work.
 Check earth wires.	Before troubleshooting or repair work, check the earth wire is connected to the earth terminals of the main unit, otherwise an electric shock is caused when a leak occurs. If the earth wire is not correctly connected, contact an electric engineer for rework. After completing the repair or relocation work, check that the earth wires are connected properly. Be sure to connect earth wire. (Grounding work) Incomplete grounding causes an electric shock. Do not connect earth wires to gas pipes, water pipes, and lightning rods or earth wires for telephone wires.
 Prohibition of modification.	Do not modify the products. Do not also disassemble or modify the parts. It may cause a fire, electric shock or injury.
 Use specified parts.	When any of the electrical parts are to be replaced, ensure that the replacement parts satisfy the specifications given in the Service Manual (or use the parts contained on the parts list in the Service Manual). Use of any parts which do not satisfy the required specifications may give rise to electric shocks, smoking and/or a fire. Replace components only with parts specified by the manufacturer. Other parts may result in the ignition of refrigerant in the atmosphere from a leak.
 Do not bring a child close to the equipment.	If, in the course of carrying out repairs, it becomes absolutely necessary to check out the electrical parts with the electrical parts box cover of one or more of the indoor units and the service panel of the outdoor unit removed in order to find out exactly where the trouble lies, place Keep out signs around the work site before proceeding. Third-party individuals may enter the work site and receive electric shocks if this warning is not heeded.
 Insulating measures	Connect the cut-off lead wires with crimp contact, etc., put the closed end side upward and then apply a water-cut method, otherwise a leak or production of fire is caused at the users' side. Under no circumstances, the power supply wire or the indoor and outdoor connecting wire must not be connected in the middle (Connection using a solder less terminal etc.) Connection trouble in the places where the wire is connected in the middle may give rise to smoking and/or a fire.
 No fire	When performing repairs using a gas burner, replace the refrigerant with nitrogen gas because the oil that coats the pipes may otherwise burn. When repairing the refrigerating cycle, take the following measures. 1) Be attentive to fire around the cycle. When using a gas stove, etc., be sure to put out fire before work; otherwise the oil mixed with refrigerant gas may catch fire. 2) Do not use a welder in the closed room. When using it without ventilation, carbon monoxide poisoning may be caused. 3) Do not bring inflammables close to the refrigerant cycle, otherwise fire of the welder may catch the inflammables.

 Refrigerant	<p>This Air Conditioner has adopted a refrigerant HFC R32 or R410A. Be sure to check the refrigerant type for outdoor unit to be combined. In case that refrigerant type is R32, this unit uses a flammable refrigerant. If refrigerant leaks and comes in contact with fire or heating part, it will create harmful gas and there is risk of fire.</p>
	<p>Check the used refrigerant name and use tools and materials of the parts which match with it. For the products which use R32 refrigerant, the refrigerant name is indicated at a position on the outdoor unit where is easy to see. To prevent miss-charging, the route of the service port is changed from one of the former R22. Be careful for miss-charging since a charging port of R32 is the same diameter as that of R410A.</p>
	<p>Do not use any refrigerant different from the one specified for complement or replacement. Otherwise, abnormally high pressure may be generated in the refrigeration cycle, which may result in a failure or explosion of the product or an injury to your body.</p>
	<p>Be sure to use the refrigerant (R32 or R410A) specified on the combined outdoor unit. If different types of refrigerant are mixed, abnormal high pressure generates in the refrigerating cycle and an injury due to breakage may be caused. If the different type of refrigerants are mixed in, be sure to recharge the refrigerant</p>
	<p>When the air conditioner has been installed or relocated, follow the instructions in the Installation Manual and purge the air completely so that no gases other than the refrigerant will be mixed in the refrigerating cycle. Failure to purge the air completely may cause the air conditioner to malfunction.</p>
	<p>Do not charge refrigerant additionally. If charging refrigerant additionally when refrigerant gas leaks, the refrigerant composition in the refrigerating cycle changes resulted in change of air conditioner characteristics or refrigerant over the specified standard amount is charged and an abnormal high pressure is applied to the inside of the refrigerating cycle resulted in cause of breakage or injury. Therefore if the refrigerant gas leaks, recover the refrigerant in the air conditioner, execute vacuuming, and then newly recharge the specified amount of liquid refrigerant. In this time, never charge the refrigerant over the specified amount.</p>
	<p>When recharging the refrigerant in the refrigerating cycle, do not mix the other refrigerant into the specified refrigerant. If air or others is mixed with the refrigerant, abnormal high pressure generates in the refrigerating cycle resulted in cause of injury due to breakage.</p>
	<p>After the installation work, confirm that refrigerant gas does not leak. If refrigerant gas leaks into the room and flows near a fire source, such as a cooking range, it may generate noxious gases, causing a fire. Never recover the refrigerant into the outdoor unit. When the equipment is moved or repaired, be sure to recover the refrigerant with recovering device. The refrigerant cannot be recovered in the outdoor unit; otherwise a serious accident such as breakage or injury is caused.</p>
<p>When the air conditioner has been installed or relocated, follow the instructions in the Installation Manual and purge the air completely so that no gases other than the refrigerant will be mixed in the refrigerating cycle. Failure to purge the air completely may cause the air conditioner to malfunction.</p>	
 Assembly/ Wiring	<p>After repair work, surely assemble the disassembled parts, and connect and lead the removed wires as before. Perform the work so that the cabinet or panel does not catch the inner wires. If incorrect assembly or incorrect wire connection was done, a disaster such as a leak or fire is caused at user fs side.</p>
 Insulator check	<p>After the work has finished, be sure to use an insulation tester set (500V Megger) to check the resistance is 1MΩ or more between the charge section and the non-charge metal section (Earth position). If the resistance value is low, a disaster such as a leak or electric shock is caused at user fs side.</p>
 Ventilation	<p>When the refrigerant gas leaks during work, execute ventilation. If the refrigerant gas touches to a fire, it may generate noxious gases, causing a fire. A case of leakage of the refrigerant and the closed room full with gas is dangerous because a shortage of oxygen occurs. Be sure to execute ventilation.</p> <p>If refrigerant gas has leaked during the installation work, ventilate the room immediately. If the leaked refrigerant gas comes in contact with fire, it may generate noxious gases, causing a fire.</p>

 Compulsion	<p>When the refrigerant gas leaks, find up the leaked position and repair it surely. If the leaked position cannot be found up and the repair work is interrupted, pump-down and tighten the service valve, otherwise the refrigerant gas may leak into the room. When gas touches to fire such as fan heater, stove or cooking stove, it may generate noxious gases, causing a fire though the refrigerant gas itself is innocuous. When installing equipment which includes a large amount of charged refrigerant such as a multi air conditioner in a sub-room, it is necessary that the density does not the limit even if the refrigerant leaks. If the refrigerant leaks and exceeds the limit density, an accident of shortage of oxygen is caused.</p> <p>Tighten the flare nut with a torque wrench in the specified manner. Excessive tighten of the flare nut may cause a crack in the flare nut after a long period, which may result in refrigerant leakage.</p> <p>Nitrogen gas must be used for the airtight test.</p> <p>The charge hose must be connected in such a way that it is not slack.</p> <p>For the installation/moving/reinstallation work, follow to the Installation Manual. If an incorrect installation is done, a trouble of the refrigerating cycle, water leak, electric shock or fire is caused.</p> <p>Install the outdoor unit properly in a location that is durable enough to support the weight of the outdoor unit. Insufficient durability may cause the outdoor unit to fall, which may result in injury.</p>
 Check after repair	<p>Once the repair work has been completed, check for refrigerant leaks, and check the insulation resistance and water drainage. Then perform a trial run to check that the air conditioner is running properly.</p> <p>After repair work has finished, check there is no trouble. If check is not executed, a fire, electric shock or injury may be caused. For a check, turn off the power breaker.</p> <p>After repair work (installation of front panel and cabinet) has finished, execute a test run to check there is no generation of smoke or abnormal sound. If check is not executed, a fire or an electric shock is caused. Before test run, install the front panel and cabinet.</p> <p>Be sure to fix the screws back which have been removed for installation or other purposes.</p>
 Do not operate the unit with the valve closed.	<p>Check the following matters before a test run after repairing piping.</p> <ul style="list-style-type: none"> • Connect the pipes surely and there is no leak of refrigerant. • The valve is opened. <p>Running the compressor under condition that the valve closes causes an abnormal high pressure resulted in damage of the parts of the compressor and etc. and moreover if there is leak of refrigerant at connecting section of pipes, the air is suctioned and causes further abnormal high pressure resulted in burst or injury.</p>
 Check after reinstallation	<p>Only a qualified installer (*1) or qualified service person (*1) is allowed to relocate the air conditioner. It is dangerous for the air conditioner to be relocated by an unqualified individual since a fire, electric shocks, injury, water leakage, noise and/or vibration may result.</p> <p>Check the following items after reinstallation.</p> <ol style="list-style-type: none"> 1) The earth wire is correctly connected. 2) The power cord is not caught in the product. 3) There is no inclination or unsteadiness and the installation is stable. <p>If check is not executed, a fire, an electric shock or an injury is caused.</p>
 Cooling check	<p>When the service panel of the outdoor unit is to be opened in order for the compressor or the area around this part to be repaired immediately after the air conditioner has been shut down, set the circuit breaker to the OFF position, and then wait at least 10 minutes before opening the service panel. If you fail to heed this warning, you will run the risk of burning yourself because the compressor pipes and other parts will be very hot to the touch. In addition, before proceeding with the repair work, wear the kind of insulated heat-resistant gloves designed to protect electricians.</p> <p>When the service panel of the outdoor unit is to be opened in order for the fan motor, reactor, inverter or the areas around these parts to be repaired immediately after the air conditioner has been shut down, set the circuit breaker to the OFF position, and then wait at least 10 minutes before opening the service panel. If you fail to heed this warning, you will run the risk of burning yourself because the fan motor, reactor, inverter heat sink and other parts will be very hot to the touch. In addition, before proceeding with the repair work, wear the kind of insulated heat-resistant gloves designed to protect electricians.</p>
 Cooling	<p>Take care not to get burned by compressor pipes or other parts when checking the cooling cycle while running the unit as they get heated while running. Be sure to put on gloves providing protection for heat.</p>

 Installation	<p>Only a qualified installer (*1) or qualified service person (*1) is allowed to install the air conditioner. If the air conditioner is installed by an unqualified individual, a fire, electric shocks, injury, water leakage, noise and/or vibration may result.</p>
	<p>Before starting to install the air conditioner, read carefully through the Installation Manual, and follow its instructions to install the air conditioner.</p>
	<p>Be sure to use the company-specified products for the separately purchased parts. Use of no specified products may result in fire, electric shock, water leakage or other failure. Have the installation performed by a qualified installer.</p>
	<p>Do not supply power from the power terminal block equipped on the outdoor unit to another outdoor unit. Capacity overflow may occur on the terminal block and may result in fire.</p>
	<p>Do not install the air conditioner in a location that may be subject to a risk of expire to a combustible gas. If a combustible gas leaks and becomes concentrated around the unit, a fire may occur.</p>
	<p>Install the indoor unit at least 2.5 m above the floor level since otherwise the users may injure themselves or receive electric shocks if they poke their fingers or other objects into the indoor unit while the air conditioner is running.</p>
	<p>Install a circuit breaker that meets the specifications in the installation manual and the stipulations in the local regulations and laws.</p>
	<p>When transporting the air conditioner, use a forklift and when moving the air conditioner by hand, move the unit with 4 people.</p>
	<p>Install a circuit breaker that meets the specifications in the installation manual and the stipulations in the local regulations and laws.</p>
	<p>Install the circuit breaker where it can be easily accessed by the agent.</p>
 Compulsion	<p>If you install the unit in a small room, take appropriate measures to prevent the refrigerant from exceeding the limit concentration even if it leaks. Consult the dealer from whom you purchased the air conditioner when you implement the measures. Accumulation of highly concentrated refrigerant may cause an oxygen deficiency accident.</p>
	<p>Do not place any combustion appliance in a place where it is directly exposed to the wind of air conditioner, otherwise it may cause imperfect combustion.</p>
 Compulsion	<p>When carrying out the pump-down work shut down the compressor before disconnecting the refrigerant pipe. Disconnecting the refrigerant pipe with the service valve left open and the compressor still operating will cause air, etc. to be sucked in, raising the pressure inside the refrigeration cycle to an abnormally high level, and possibly resulting in reputing, injury, etc.</p>
	<p>When removing the welding parts of suction and discharge pipe for the compressor, remove them at the place ventilated well after recovering the refrigerant. Improper recovering may cause the spurt of the refrigerant and the refrigeration oil, causing an injury.</p>
 Prohibition	<p>Do not vent gases to the atmosphere. Venting gases to the atmosphere is prohibited by the law.</p>

CAUTION

 Wearing of gloves	<p>Ensure wearing of gloves when performing any work in order to avoid injury from parts, etc. Failure to wear the proper protective gloves cause an injury due to the parts, etc.</p>
 Confirm	<p>When performing the welding work, check whether refrigerant leaks or remains. If the leakage refrigerant gas touches a fire source, it may generate noxious gases, causing a fire.</p>

Explanations given to user

If you have discovered that the fan grille is damaged, do not approach the outdoor unit but set the circuit breaker to the OFF position, and contact a qualified service person to have the repairs done. Do not set the circuit breaker to the ON position until the repairs are completed.

Relocation

- Only a qualified installer (*1) or qualified service person (*1) is allowed to relocate the air conditioner. It is dangerous for the air conditioner to be relocated by an unqualified individual since a fire, electric shocks, injury, water leakage, noise and / or vibration may result.
- When carrying out the pump-down work shut down the compressor before disconnecting the refrigerant pipe. Disconnecting the refrigerant pipe with the service valve left open and the compressor still operating will cause air, etc. to be sucked in, raising the pressure inside the refrigeration cycle to an abnormally high level, and possibly resulting in reputing, injury, etc.

(*1) Refer to the “Definition of Qualified Installer or Qualified Service Person”

Declaration of Conformity

Manufacturer: TOSHIBA CARRIER CORPORATION
336 Tadehara, Fuji-shi, Shizuoka-ken 416-8521 JAPAN

TCF holder: TOSHIBA CARRIER EUROPE S.A.S
Route de Thil
01120 Montluel FRANCE

Hereby declares that the machinery described below:

Generic Denomination: Air Conditioner

Model / type: Indoor unit
Compact 4-way Cassette
RAV-RM301MUT-E RAV-RM301MUT-TR
RAV-RM401MUT-E RAV-RM401MUT-TR
RAV-RM561MUT-E RAV-RM561MUT-TR

Commercial name: Digital Inverter Series, Super Digital Inverter Series Air Conditioner

Complies with the provisions of the “Machinery” Directive (Directive 2006/42/EC) and the regulations transposing into national law

NOTE

This declaration becomes invalid if technical or operational modifications are introduced without the manufacturer’s consent.

Specifications

Model	Sound presser level (dB(A))		Weight (kg) Main unit (Ceiling panel)
	Cooling	Heating	
RAV-RM301MUT-E	*	*	15 (2.5)
RAV-RM401MUT-E	*	*	15 (2.5)
RAV-RM561MUT-E	*	*	15 (2.5)
RAV-RM301MUT-TR	*	*	15 (2.5)
RAV-RM401MUT-TR	*	*	15 (2.5)
RAV-RM561MUT-TR	*	*	15 (2.5)

※: Under 70 (dB(A))

About refrigerant R32

This air conditioner adopts a new HFC type refrigerant (R32) which does not deplete the ozone layer.

1. Safety Caution Concerned to Refrigerant R32

Be sure that water, dust, the former refrigerant or the former refrigerating oil is not mixed into the refrigerating cycle of the air conditioner with refrigerant R32 during installation work or service work. If an incorrect work or incorrect service is performed, there is a possibility to cause a serious accident. Use the tools and materials exclusive to R32 to purpose a safe work.

2. Safety and Cautions on Installation/Service

<Safety items>

When gas concentration and ignition energy are happened at the same time, R32 has a slight possibility of burning. Although it will not ignite under normal work environment conditions, be aware that the flame spreads if ignition should occur.

It is necessary to carry out installation/servicing safely while taking the following precautions into consideration.

- 1) Never use refrigerant other than specified refrigerant (R32) in an air conditioner which is designed to operate with the specified refrigerant (R32).
If other refrigerant than R32 is used, it may cause personal injury, etc. by a malfunction, a fire, a rupture.
- 2) Since R32 is heavier than air, it tends to accumulate on the bottom (near the floor).
Ventilate properly for the working environment to prevent its combustion.
Especially in a basement or a closed room where is the high risk of the accumulation, ventilate the room with a local exhaust ventilation.
If refrigerant leakage is confirmed in the room or the place where the ventilation is insufficient, do not work until the proper ventilation is performed and the work environment is improved.
- 3) When performing brazing work, be sure to check for leakage refrigerant or residual refrigerant.
If the leakage refrigerant comes into contact with fire, a poisonous gas may occur or it may cause a fire.
Keep adequate ventilation during the work.
- 4) When refrigerant gas leaks during work, execute ventilation. If the leakage refrigerant comes into contact with a fire, a poisonous gas may occur or it may cause a fire.
- 5) In places where installing / repairing air-conditioning equipment, etc., keep the source of ignition such as gas combustion equipment, petroleum combustion equipment, electric heater etc. away. Do not smoke in the place.
- 6) When installing or removing an air conditioner, do not mix air in the refrigerant cycle.
If air or others is mixed with the refrigerant, abnormal high pressure generates in the refrigerating cycle, causing injury due to the breakage.
- 7) After installation work complete, confirm that refrigerant gas is not leaking on the flare connection part or others. If leaked refrigerant comes to contact with a fire, toxic gas may occur, causing a fire.
- 8) Perform the installation work and re-installation according to the installation manual.
Pay attention especially to the area of application. Improper installation may cause refrigeration trouble or water leakage, electric shock and fire etc.
- 9) Unauthorized modifications to the air conditioner may be dangerous. If a breakdown occurs please call a qualified air conditioner technician or electrician.
Improper repair may result in water leakage, electric shock and fire, etc.
- 10) Carry out the airtight test with nitrogen at a specified pressure. Do not use oxygen or acetylene gas absolutely as it may cause an explosion.
- 11) Always carry a refrigerant leakage detection sensor during the work and work while checking that no refrigerant leaks around working environment.
- 12) If the leakage refrigerant comes into contact with fire, it may cause a fire.
Have a dry powder or CO₂ fire extinguisher adjacent to the charging area.

<Caution items>

- 1) The opposite side dimension of the air-conditioner's flared nut using R32 and the shape of the charge port are the same as those of R410A.
- 2) Be careful not to charge refrigerant by mistake. Should the different type of refrigerant mix in, be sure to recharge the refrigerant
- 3) Do not mix the other refrigerant or refrigerating oil with the refrigerant.
- 4) Since the pressure of R32 is high 1.6 times of that of the former refrigerant (R22), use tools and parts with high pressure withstand specification similar to R410A.
- 5) In the installation time, use clean pipe materials and work with great attention so that water and others do not mix in because pipes are affected by impurities such as water, oxide film, oil, etc. Use the clean pipes. Be sure to braze while flowing nitrogen gas in the pipe. (Never use gas other than nitrogen gas.)
- 6) For the earth protection, use a vacuum pump for air purge.
- 7) R32 refrigerant is Single-component refrigerant that does not change its composition. Although it is possible to charge the refrigerant with either liquid or gas, charge it with liquid. (If using gas for charging, composition of the refrigerant changes and then characteristics of the air conditioner change.)

3. Pipe Materials

For the refrigerant pipes, copper pipe and joints are mainly used.
 It is necessary to select the most appropriate pipes to conform to the standard.
 Use clean material in which impurities adhere inside of pipe or joint to a minimum.

1) Copper pipe

<Piping>
 The pipe thickness, flare finishing size, flare nut and others differ according to a refrigerant type. When using a long copper pipe for R32, it is recommended to select "Copper or copper-base pipe without seam" and one with bonded oil amount 40mg/10m or less. Also do not use crushed, deformed, discolored (especially inside) pipes. (Impurities cause clogging of expansion valves and capillary tubes.)

<Flare nut>
 Use the flare nuts which are attached to the air conditioner unit.

Be sure to select the pipes with copper thickness in the table below since the pressure of an air conditioner using R32 is higher than that of R22.

Nominal diameter	Outer diameter (mm)	Thickness (mm) R410A or R32
1/2	6.4	0.80
3/8	9.5	0.80
1/2	12.7	0.80
5/8	15.9	1.00

Make sure not to use a thin copper pipe such as 0.7 mm copper thickness in the market.

2) Joint

The flare joint and socket joint are used for joints of the copper pipe. The joints are rarely used for installation of the air conditioner. However clear impurities when using them.

4. Tools

Tools exclusive for R410A (The following tools for R410A are required.)

○: R410A tools available

△: Partly unavailable, ×: R410A tools unavailable

No.	Installation/service tools		Use	Applicability to R32 air conditioner or not	Applicability to R22 air conditioner or not
	Tools / Equipment	specification			
1	Flare tool	Clutch type	Pipe flaring	○	○
2	Copper pipe gauge for adjusting projection margin	—	Flaring by conventional flare tool	○	—
3	Torque wrench	—	Tightening of flare nut	○	×
4	Gauge manifold	Port size 1/2"-20UNF (5/16" Flare)	Evacuating, refrigerant charge, run check, etc.	○ Note 2	×
5	Charge hose	High-voltage		○	×
6	Vacuum pump	—	Vacuum drying	○ Note 3 1/2"-20UNF(5/16" Flare)	△ Connection diameter 1/4"
7	Vacuum pump adapter	—	Vacuum drying	○ Note 4 1/2"-20UNF(5/16" Flare)	△ Connection diameter 1/4"
8	Electronic balance for refrigerant charging	For 10 kg or 20 kg cylinder	Refrigerant charge	○	○
9	Leakage detector	—	Gas leakage check	○ Note 5	○ Note 5
10	Refrigerant cylinder	—	Refrigerant charge	× Note 6	×
11	Refrigerant recovery cylinder	Exclusive for R32	Refrigerant recovery container	× Note 7	×
12	Refrigerant recovery device	—	Refrigerant recovery device	○ Note 8	△ Connection diameter 1/4"

Note 1 When flaring is carried out for R410A or R32 using the conventional flare tools, adjustment of projection margin is necessary. For this adjustment, a copper pipe gauge, etc. are necessary.

Note 2 When saturation temperature is described, the gauge manifold differs for R410A and R32. If saturation temperature reading is required, special tools exclusive for R32 are required.

Note 3 Since R32 has a slight possibility of burning, be sure to use the tools corresponding to R32.

Note 4 Like R410, a Vacuum pump adapter needs installing to prevent a Vacuum pump oil (mineral oil) from flowing backward into the Charge hose. Mixing of the Vacuum pump oil into R32 refrigerant may cause a trouble such as generation of sludge, clogging of capillary, etc.

Note 5 Be sure to use those tools after confirming they correspond to each refrigerant.

Note 6 For a refrigerant cylinder exclusive for R32, the paint color (or label color) of the cylinder is set to the specified color (light blue) together with the indication of the refrigerant name.

Note 7 Although the container specification is the same as R410A, use a recovering container exclusive for R32 to avoid mixing with other refrigerants.

Note 8 Be careful for miss-charging of the refrigerant during work. Miss-charging of the refrigerant type may cause not only damage of the equipments but also a fire etc.

General tools

In addition to the above exclusive tools, the following equipments are necessary as the general tools.

- | | |
|-----------------------|-----------------------------|
| 1) Pipe cutter | 6) Spanner or Monkey wrench |
| 2) Reamer | 7) Hole core drill |
| 3) Pipe bender | 8) Tape measure |
| 4) Level vial | 9) Metal saw |
| 5) Screwdriver (+, -) | |

Also prepare the following equipments for other installation method and run check.

- | | |
|----------------|--|
| 1) Clamp meter | 3) Insulation resistance tester (Megger) |
| 2) Thermometer | 4) Electroscopes |

About refrigerant R410A

This air conditioner adopts a HFC type refrigerant (R410A) which does not deplete the ozone layer.

1. Safety Caution Concerned to R410A Refrigerant

The pressure of R410A is high 1.6 times of that of the former refrigerant (R22).

Accompanied with change of refrigerant, the refrigerating oil has been also changed.

Therefore, be sure that water, dust, the former refrigerant or the former refrigerating oil is not mixed into the refrigerating cycle of the air conditioner with R410A refrigerant during installation work or service work.

If an incorrect work or incorrect service is performed, there is a possibility to cause a serious accident.

Use the tools and materials exclusive to R410A to purpose a safe work.

2. Cautions on Installation/Service

1) Do not mix the other refrigerant or refrigerating oil.

For the tools exclusive to R410A, shapes of all the joints including the service port differ from those of the former refrigerant in order to prevent mixture of them.

2) As the use pressure of the R410A refrigerant is high, use material thickness of the pipe and tools which are specified for R410A.

3) In the installation time, use clean pipe materials and work with great attention so that water and others do not mix in because pipes are affected by impurities such as water, oxide scales, oil, etc.

Use the clean pipes.

Be sure to brazing with flowing nitrogen gas. (Never use gas other than nitrogen gas.)

4) For the earth protection, use a vacuum pump for air purge.

5) R410A refrigerant is azeotropic mixture type refrigerant.

Therefore use liquid type to charge the refrigerant. (If using gas for charging, composition of the refrigerant changes and then characteristics of the air conditioner change.)

3. Pipe Materials

For the refrigerant pipes, copper pipe and joints are mainly used.

It is necessary to select the most appropriate pipes to conform to the standard.

Use clean material in which impurities adhere inside of pipe or joint to a minimum.

1) Copper pipe

<Piping>

The pipe thickness, flare finishing size, flare nut and others differ according to a refrigerant type.

When using a long copper pipe for R410A, it is recommended to select "Copper or copper-base pipe without seam" and one with bonded oil amount 40mg/10m or less.

Also do not use crushed, deformed, discolored (especially inside) pipes.

(Impurities cause clogging of expansion valves and capillary tubes.)

<Flare nut>

Use the flare nuts which are attached to the air conditioner unit.

2) Joint

The flare joint and socket joint are used for joints of the copper pipe.

The joints are rarely used for installation of the air conditioner. However clear impurities when using them.

4. Tools

1. Required Tools for R410A

Mixing of different types of oil may cause a trouble such as generation of sludge, clogging of capillary, etc. Accordingly, the tools to be used are classified into the following three types.

- 1) Tools exclusive for R410A (Those which cannot be used for conventional refrigerant (R22))
- 2) Tools exclusive for R410A, but can be also used for conventional refrigerant (R22)
- 3) Tools commonly used for R410A and for conventional refrigerant (R22)

The table below shows the tools exclusive for R410A and their interchangeability.

Tools exclusive for R410A (The following tools for R410A are required.)

Tools whose specifications are changed for R410A and their interchangeability

No.	Used tool	Usage	R410A air conditioner installation		Conventional air conditioner installation
			Existence of new equipment for R410A	Whether conventional equipment can be used	Whether conventional equipment can be used
①	Flare tool	Pipe flaring	Yes	* (Note)	Yes
②	Copper pipe gauge for adjusting projection margin	Flaring by conventional flare tool	Yes	* (Note)	* (Note)
③	Torque wrench	Tightening of flare nut	Yes	No	No
④	Gauge manifold	Evacuating, refrigerant charge, run check, etc.	Yes	No	No
⑤	Charge hose				
⑥	Vacuum pump adapter	Vacuum evacuating	Yes	No	Yes
⑦	Electronic balance for refrigerant charging	Refrigerant charge	Yes	Yes	Yes
⑧	Refrigerant cylinder	Refrigerant charge	Yes	No	No
⑨	Leakage detector	Gas leakage check	Yes	No	Yes

(Note) When flaring is carried out for R410A using the conventional flare tools, adjustment of projection margin is necessary. For this adjustment, a copper pipe gauge, etc. are necessary.

General tools (Conventional tools can be used.)

In addition to the above exclusive tools, the following equipments which serve also for R22 are necessary as the general tools.

- | | |
|---|--|
| 1) Vacuum pump. Use vacuum pump by attaching vacuum pump adapter. | |
| 2) Torque wrench | 8) Spanner or Monkey wrench |
| 3) Pipe cutter | 9) Hole core drill |
| 4) Reamer | 10) Hexagon wrench (Opposite side 4mm) |
| 5) Pipe bender | 11) Tape measure |
| 6) Level vial | 12) Metal saw |
| 7) Screwdriver (+, -) | |

Also prepare the following equipments for other installation method and run check.

- | | |
|----------------|--|
| 1) Clamp meter | 3) Insulation resistance tester (Megger) |
| 2) Thermometer | 4) Electroscop |

1. SPECIFICATIONS

SDI combination (R32)

<Single type>

Model name	Indoor Unit		RAV-RM	561MUT-E	
	Outdoor Unit		RAV-GP	561ATP-E	
Cooling capacity (Rated (Min.-Max.))			kW	5.0 (1.2-5.6)	
Heating capacity (Rated (Min.-Max.))			kW	5.6 (0.9-7.0)	
Power supply			1 phase 50Hz 230V (220V-240V)		
Electrical characteristics (*1)	Cooling	Running current		A	7.49 - 6.87
		Power consumption		kW	1.56
		Power factor		%	94
		EER			3.21
	Heating	Running current		A	7.68 - 7.04
		Power consumption		kW	1.60
		Power factor		%	95
		COP			3.5
	Maximum current			A	13.1
Indoor Unit					
Appearance	Main Unit			Zinc hot dipping steel plate * Heat-insulating material attached to only upper plate	
	Ceiling panel (Sold Separately)	Model name		RBC-UM21PG(W)-E	
Color		Gran White (Mansell 5PB9/1)			
Outer dimension	Main unit	H x W x D (*3)	mm	256 x 575 x 575	
	Ceiling panel (Sold Separately)	H x W x D (*3)	mm	12 x 620 x 620	
Weight	Main unit		kg	15.0	
	Ceiling panel (Sold Separately)		kg	2.5	
Heat exchanger			Finned tube		
Fan unit	Fan			Turbo fan	
	Standard air flow (M+ / M / L+ / L)		m³/h	798 (720 / 672 / 562 / 546)	
	Motor		W	60	
Air filter			Standard filter (Long life filter)		
Drain port (Nominal dia. mm)			VP20 (Polyvinyl chloride tube)		
Sound pressure level High (M+ / M / L+ / L)			dB(A)	44 (42 / 39 / 36 / 35)	
Sound power level High (M+ / M / L+ / L) (*2)			dB(A)	59 (57 / 54 / 51 / 50)	
Outdoor Unit					
Refrigerant (Type / Charge weight (kg))			R32/1.35		
Outer dimension		H x W x D	mm	630 x 799 x 299	
Weight				kg	45
Sound pressure level		Cooling/Heating	dB(A)	46 / 48	
Sound power level		Cooling/Heating	dB(A)	63 / 65	
Pipe connections		Gas / Liquid		mm	12.7 / 6.4
		Min. Length		m	3
		Max. Length		m	50
		Chargeless		m	20
		Max. height difference		m	30
Operation Range		Cooling	°C	-15 to 52	
		Heating	°C	-27 to 15	

*1 : The Cooling capacity and electrical characteristics are measured under the conditions specified by JIS B 8615-1 based on the reference piping.

The reference piping consists of 5m of main piping and 2.5m of branch piping connected with 0 meter height.

*2 : The sound level are measured in an anechoic chamber in accordance with JIS B 8616. Normally, the values measured in the actual operation environment become larger than the indicated values due to the effects of external sound.

*3 : Height from the ceiling. Depth doesn't include the electric parts box.

Notes ;

Rated conditions Cooling : Indoor air temperature 27°CDB/ 19 °CWB, Outdoor air temperature 35°CDB
Heating : Indoor air temperature 20°CDB, Outdoor air temperature 7°CDB/ 6°CWB

SDI combination (R410A)

<Single type>

Model name	Indoor Unit		RAV-RM	401MUT-E	561MUT-E	
	Outdoor Unit		RAV-SP	404ATP-E	564ATP-E	
Cooling capacity (Rated (Min.-Max.))			kW	3.6 (1.5 - 4.0)	5.0 (1.2 - 5.6)	
Heating capacity (Rated (Min.-Max.))			kW	4.0 (1.5 - 5.0)	5.6 (0.9 - 7.4)	
Power supply			1phase 50Hz 230V(220V-240V)			
Electrical characteristics (*1)	Cooling	Running current		A	4.69 - 4.30	7.26 - 6.66
		Power consumption		kW	0.95	1.55
		Power factor		%	92	97
		EER			3.79	3.23
	Heating	Running current		A	4.74 - 4.35	7.17 - 6.57
		Power consumption		kW	0.96	1.53
		Power factor		%	92	97
		COP			4.17	3.66
Maximum current				15.0	13.6	
Indoor Unit						
Appearance	Main Unit			Zinc hot dipping steel plate * Heat-insulating material attached to only upper plate		
	Ceiling panel (Sold Separately)	Model name		RBC-UM21PG(W)-E		
		Color		Gran White (Mansell 5PB9/1)		
Outer dimension	Main unit	H x W x D (*3)		mm	256 x 575 x 575	
	Ceiling panel (Sold Separately)	H x W x D (*3)		mm	12 x 620 x 620	
Weight	Main unit			kg	15.0	
	Ceiling panel (Sold Separately)			kg	2.5	
Heat exchanger			Finned tube			
Fan unit	Fan			Turbo fan		
	Standard air flow (M+ / M / L+ / L)			m ³ /h	660(610/552/480/468)	798(720/672/562/546)
	Motor			W	60	
Air filter			Standard filter (Long life filter)			
Drain port (Nominal dia. mm)			VP20 (Polyvinyl chloride tube)			
Sound pressure level High (M+ / M / L+ / L)			dB(A)	41 (38 / 36 / 33 / 32)	44 (42 / 39 / 36 / 35)	
Sound power level High (M+ / M / L+ / L)			dB(A)	56 (53 / 51 / 48 / 47)	59 (57 / 54 / 51 / 50)	
Outdoor Unit						
Refrigerant (Type / Charge weight (kg))			R410A / 1.0		R410A / 1.4	
Outer dimension	H x W x D		mm	550 x 780 x 290		
Weight			kg	40	44	
Sound pressure level	Cooling/Heating		dB(A)	45 / 47	47 / 48	
Sound power level	Cooling/Heating		dB(A)	62 / 64	63 / 64	
Pipe connections	Gas / Liquid		mm	Ø 12.7 / Ø 6.4		
	Min. Length		m	5		
	Max. Length		m	30		
	Chargeless		m	20		
	Max. height difference		m	30		
Operation Range	Cooling		°C	-15 to 43		
	Heating		°C	-15 to 15	-20 to 15	

*1 : The Cooling capacity and electrical characteristics are measured under the conditions specified by JIS B 8615-1 based on the reference piping.

The reference piping consists of 5m of main piping and 2.5m of branch piping connected with 0 meter height.

*2 : The sound level are measured in an anechoic chamber in accordance with JIS B 8616. Normally, the values measured in the actual operation environment become larger than the indicated values due to the effects of external sound.

*3 : Height from the ceiling. Depth doesn't include the electric parts box.

Notes ;

Rated conditions Cooling : Indoor air temperature 27°CDB/ 19 °CWB, Outdoor air temperature 35°CDB
Heating : Indoor air temperature 20°CDB, Outdoor air temperature 7°CDB/ 6°CWB

DI combination (R410A)

<Single type>

Model name	Indoor Unit		RAV-RM	301MUT-E	401MUT-E	561MUT-E	
	Outdoor Unit		RAV-SM	304ATP-E	404ATP-E	564ATP-E	
Cooling capacity (Rated (Min.-Max.))			kW	2.5 (0.9 - 3.0)	3.6 (0.9 - 4.0)	5.0 (1.5 - 5.6)	
Heating capacity (Rated (Min.-Max.))			kW	3.4 (0.8 - 4.5)	4.0 (0.8 - 5.0)	5.3 (1.5 - 6.3)	
Power supply			1phase 50Hz 230V(220V-240V)				
Electrical characteristics	Cooling	Running current		A	2.98 - 2.73	4.40 - 4.03	7.93 - 7.27
		Power consumption		kW	0.59	0.90	1.64
		Power factor		%	90	93	94
		EER			4.24	4.00	3.05
	Heating	Running current		A	3.75 - 3.44	4.64 - 4.26	7.18 - 6.59
		Power consumption		kW	0.76	0.95	1.47
		Power factor		%	92	93	93
		COP			4.47	4.21	3.61
	Maximum current				7.90	9.20	12.5
	Indoor Unit						
Appearance	Main Unit			Zinc hot dipping steel plate * Heat-insulating material attached to only upper plate			
	Ceiling panel (Sold Separately)	Model name		RBC-UM21PG(W)-E			
		Color		Gran White (Mansell 5PB9/1)			
Outer dimension	Main unit	H x W x D (*3)		mm	256 x 575 x 575		
	Ceiling panel (Sold Separately)	H x W x D (*3)		mm	12 x 620 x 620		
Weight	Main unit			kg	15.0		
	Ceiling panel (Sold Separately)			kg	2.5		
Heat exchanger			Finned tube				
Fan unit	Fan			Turbo fan			
	Standard air flow (M+ / M / L+ / L)			m ³ /h	640(574/520/450/440)	660(610/552/480/468)	798(720/672/562/546)
	Motor			W	60		
Air filter			Standard filter (Long life filter)				
Drain port (Nominal dia. mm)			VP20 (Polyvinyl chloride tube)				
Sound pressure level High (M+ / M / L+ / L)			dB(A)	38 (37 / 36 / 31 / 30)	41 (38 / 36 / 33 / 32)	44 (42 / 39 / 36 / 35)	
Sound power level High (M+ / M / L+ / L)			dB(A)	53 (52 / 51 / 46 / 45)	56 (53 / 51 / 48 / 47)	59 (57 / 54 / 51 / 50)	
Outdoor Unit							
Refrigerant (Type / Charge weight (kg))			R410A / 0.8		R410A / 1.4	R410A / 1.1	
Outer dimension	H x W x D		mm	550 x 780 x 290			
Weight			kg	33	39	40	
Sound pressure level	Cooling/Heating		dB(A)	46 / 47	49 / 50	46 / 48	
Sound power level	Cooling/Heating		dB(A)	61 / 62	64 / 65	63 / 65	
Pipe connections	Gas / Liquid		mm	Ø 9.5 / Ø 6.4		Ø 12.7 / Ø 6.4	
	Min. Length		m	2.0		5.0	
	Max. Length		m	20		30	
	Chargeless		m	15		20	
	Max. height difference		m	10		30	
Operation Range	Cooling		°C	-15 to 46			
	Heating		°C	-15 to 24		-15 to 15	

*1 : The Cooling capacity and electrical characteristics are measured under the conditions specified by JIS B 8615-1 based on the reference piping.

The reference piping consists of 5m of main piping and 2.5m of branch piping connected with 0 meter height.

*2 : The sound level are measured in an anechoic chamber in accordance with JIS B 8616. Normally, the values measured in the actual operation environment become larger than the indicated values due to the effects of external sound.

*3 : Height from the ceiling. Depth doesn't include the electric parts box.

Notes ;

Rated conditions Cooling : Indoor air temperature 27°CDB/ 19 °CWB, Outdoor air temperature 35°CDB
Heating : Indoor air temperature 20°CDB, Outdoor air temperature 7°CDB/ 6 °CWB

Specifications for ErP Lot-10

Compact 4way Cassette <Series 1>

Refrigerant : R32

No	Outdoor unit type	Connection type	HP	Indoor unit		Outdoor unit		Rated Capacity (kW)		Specifications					
				Model name	Qty	Model name	Qty	Cooling	Heating	SEER	Energy Label	Pdesign _C	SCOP (average)	Energy Label	Pdesign _h (average)
1	SDI	Single	2.0	RAV-FM561MUT-E	1	RAV-GP561ATP-E	1	5.0	5.6	6.02	A+	5.0	4.30	A+	3.8

Refrigerant : R410A

No	Outdoor unit type	Connection type	HP	Indoor unit		Outdoor unit		Rated Capacity (kW)		Specifications					
				Model name	Qty	Model name	Qty	Cooling	Heating	SEER	Energy Label	Pdesign _C	SCOP (average)	Energy Label	Pdesign _h (average)
1	DI	Single	1.0	RAV-RM301MUT-E	1	RAV-SM304ATP-E	1	2.5	3.4	5.53	A	2.5	4.60	A++	2.3
2	DI	Single	1.5	RAV-RM401MUT-E	1	RAV-SM404ATP-E	1	3.6	4.0	5.35	A	3.6	4.34	A+	3.2
3	DI	Single	2.0	RAV-RM561MUT-E	1	RAV-SM564ATP-E	1	5.0	5.3	5.49	A	5.0	4.27	A+	3.9
4	SDI	Single	1.5	RAV-RM401MUT-E	1	RAV-SP404ATP-E	1	3.6	4.0	5.87	A+	3.6	4.49	A+	3.4
5	SDI	Single	2.0	RAV-RM561MUT-E	1	RAV-SP564ATP-E	1	5.0	5.6	5.94	A+	5.0	4.42	A+	3.9

3. WIRING DIAGRAMS

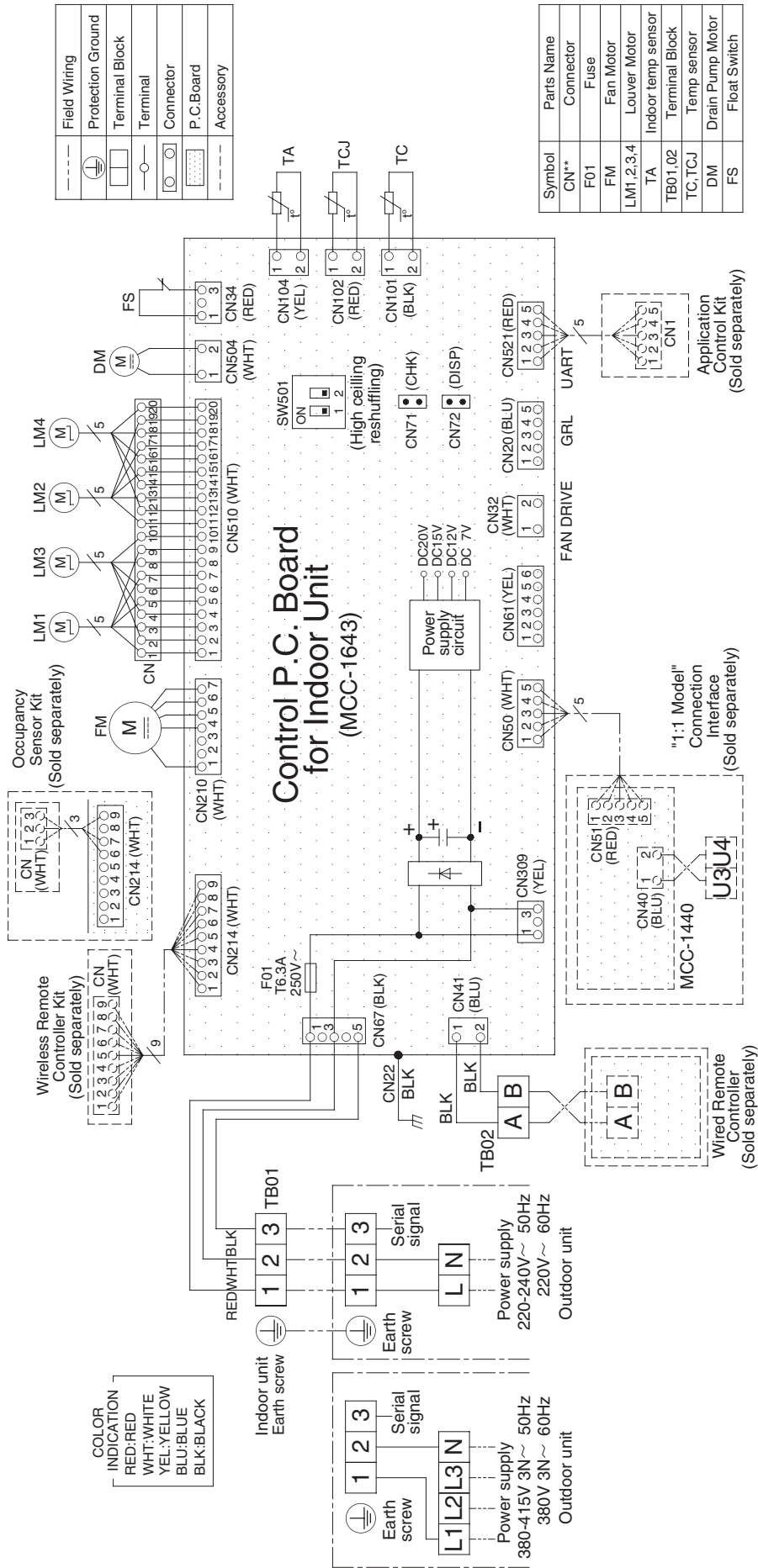

4. PARTS RATING

Indoor unit

Model	RAV-	RM30*	RM40*	RM56*
Fan motor			ICF-340D60-1	
Louver motor			MSBPC20F04	
Float switch			FS-0218-102	
Drain pump motor			MDP-1401	
TA sensor			Lead wire length: 818 mm Vinyl tube	
TC sensor			Ø6 size lead wire length: 500 mm Vinyl tube (Black)	
TCJ sensor			Ø6 size lead wire length: 400 mm Vinyl tube (Red)	

5. SYSTEMATIC REFRIGERATING CYCLE DIAGRAM

5-1. Indoor Unit

- Single type (Combination of 1 indoor unit and 1 outdoor unit)

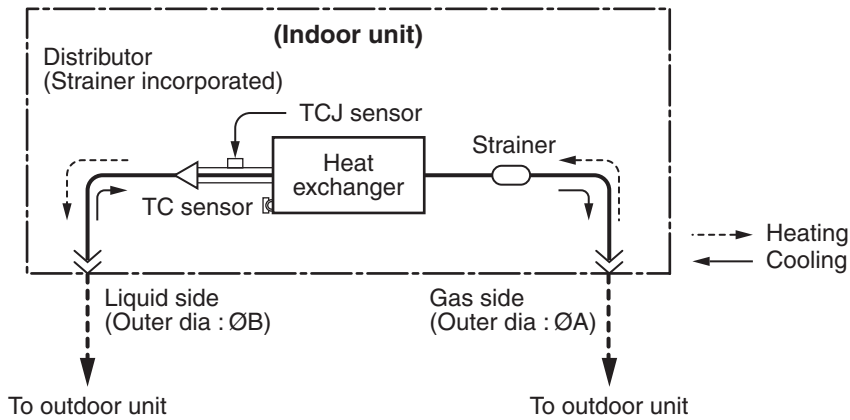

Dimension table

Indoor unit	Outer diameter of refrigerant pipe	
	Gas side ØA	Liquid side ØB
RM30 type	9.5	6.4
RM40, 56 type	12.7	6.4

- Twin type (Combination of 2 indoor units and 1 outdoor unit)

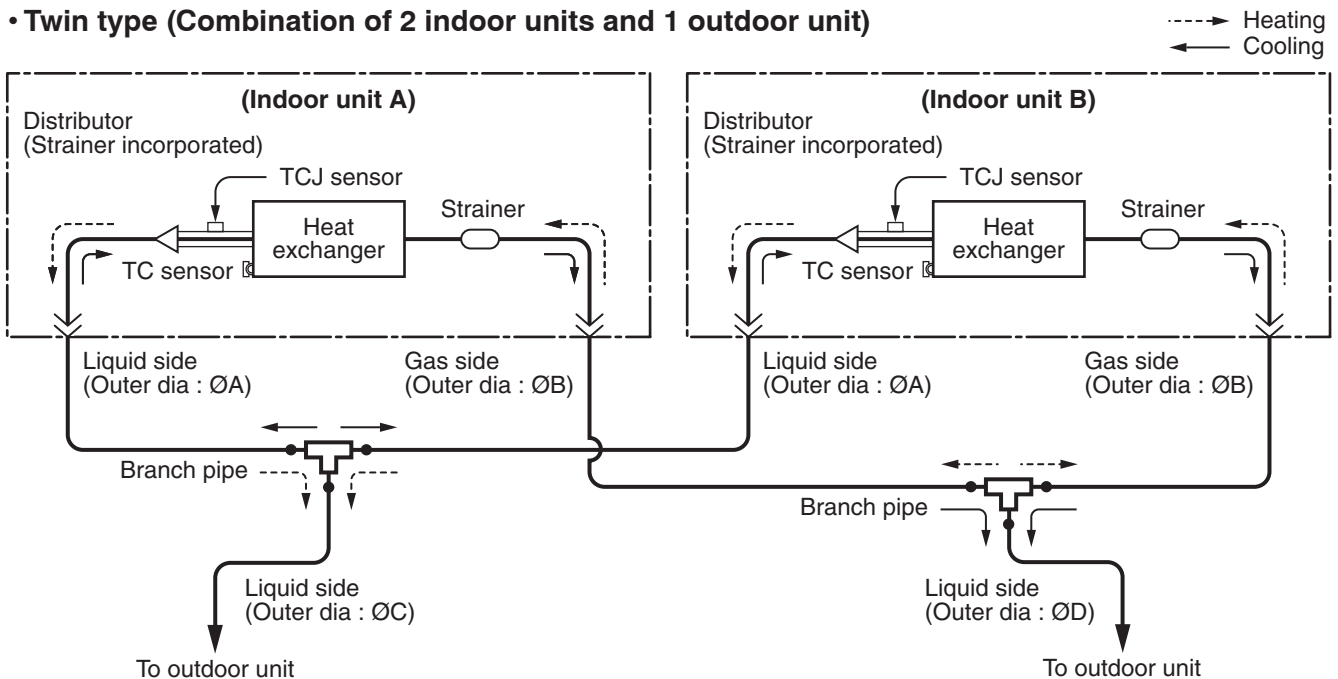

Indoor unit	Branch pipe	A	B	C	D
RM40 × 2	RBC-TWP30E2	6.4	12.7	9.5	15.9
RM56 × 2	RBC-TWP30E2	6.4	12.7	9.5	15.9

● Triple type (3 indoor units and 1 outdoor unit)

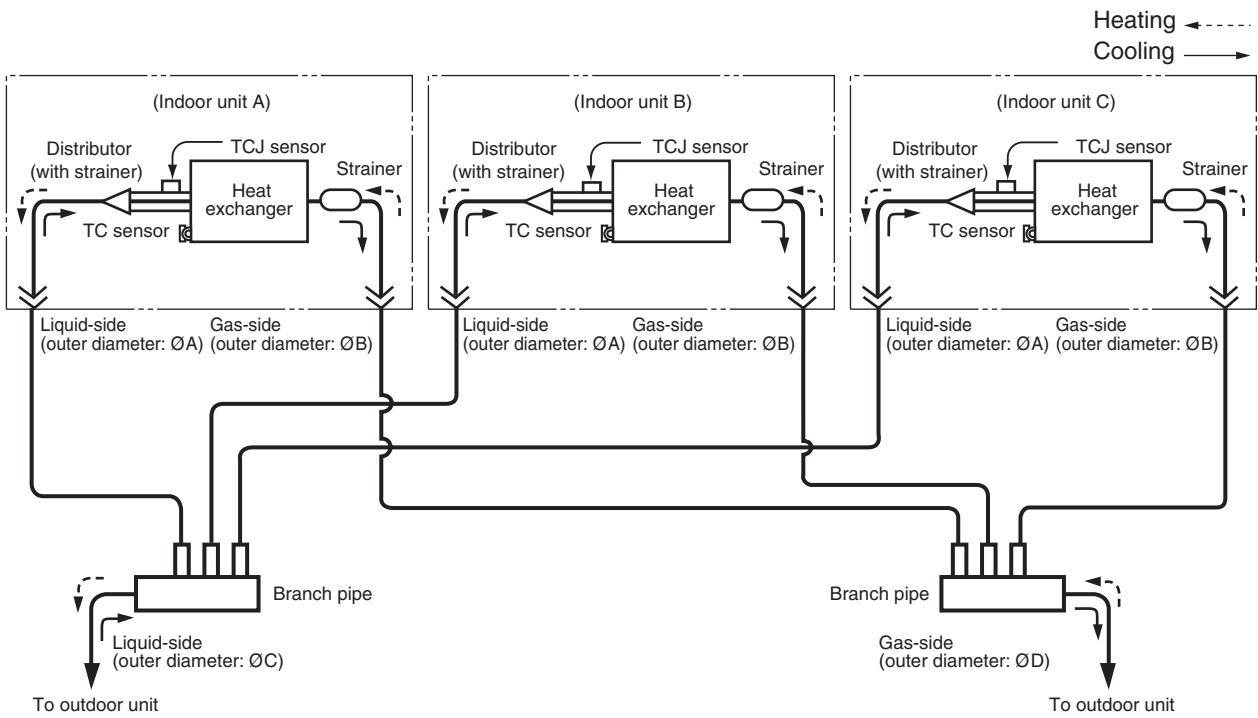

Dimension table

Indoor unit	Branch pipe	A	B	C	D
RM56 × 3	RBC-TRP100E	6.4	12.7	9.5	15.9

● Double-twin type (4 indoor units and 1 outdoor unit)

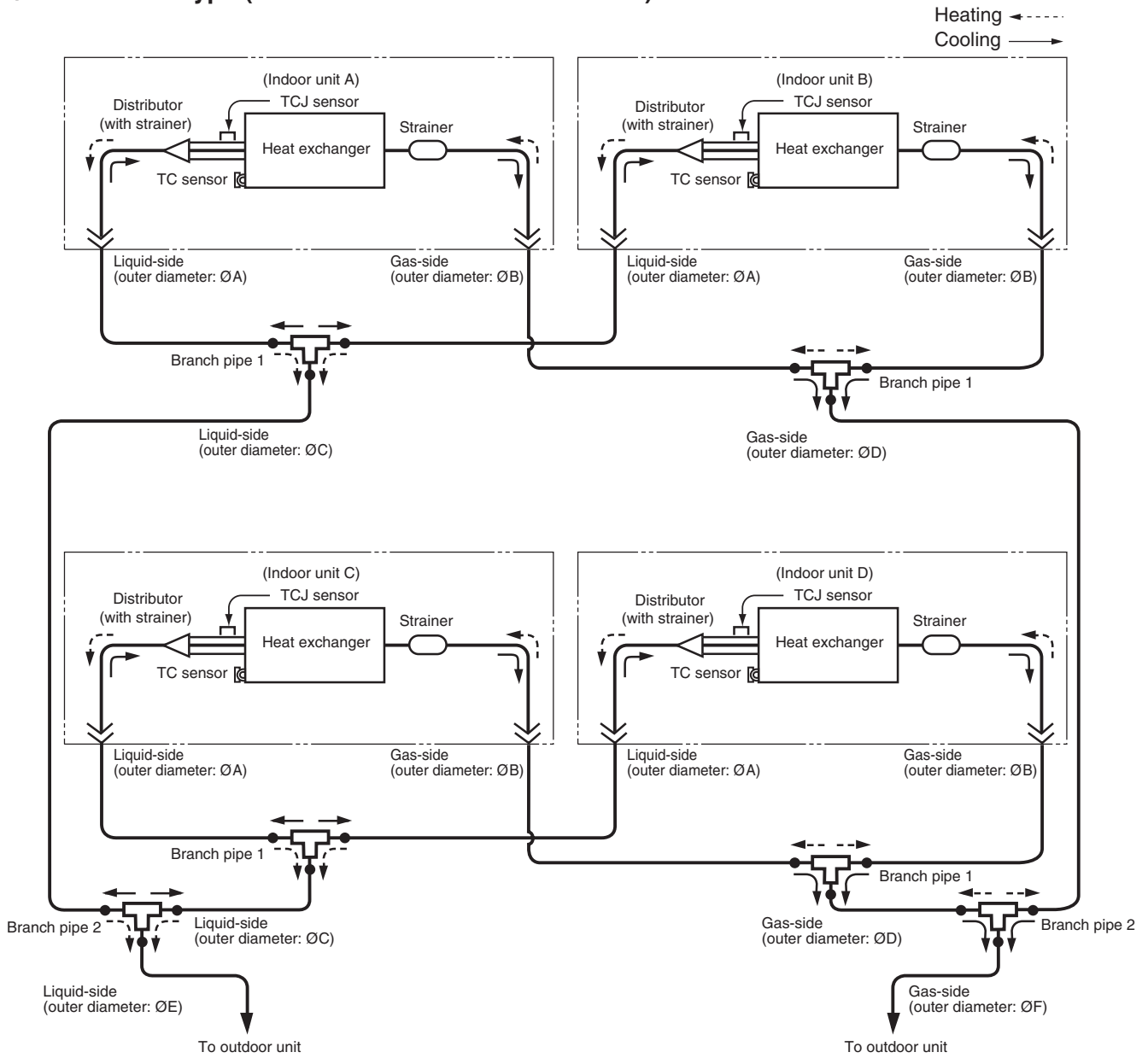

Dimension table

Indoor unit	Branch pipe 1	Branch pipe 2	A	B	C	D	E	F
RM56 × 4	RBC-TWP30E2x2	RBC-TWP101E	6.4	12.7	9.5	15.9	12.7	28.6

6-1-2. Connection of Wireless Remote Controller Kit

Indoor unit
#1 (Header)

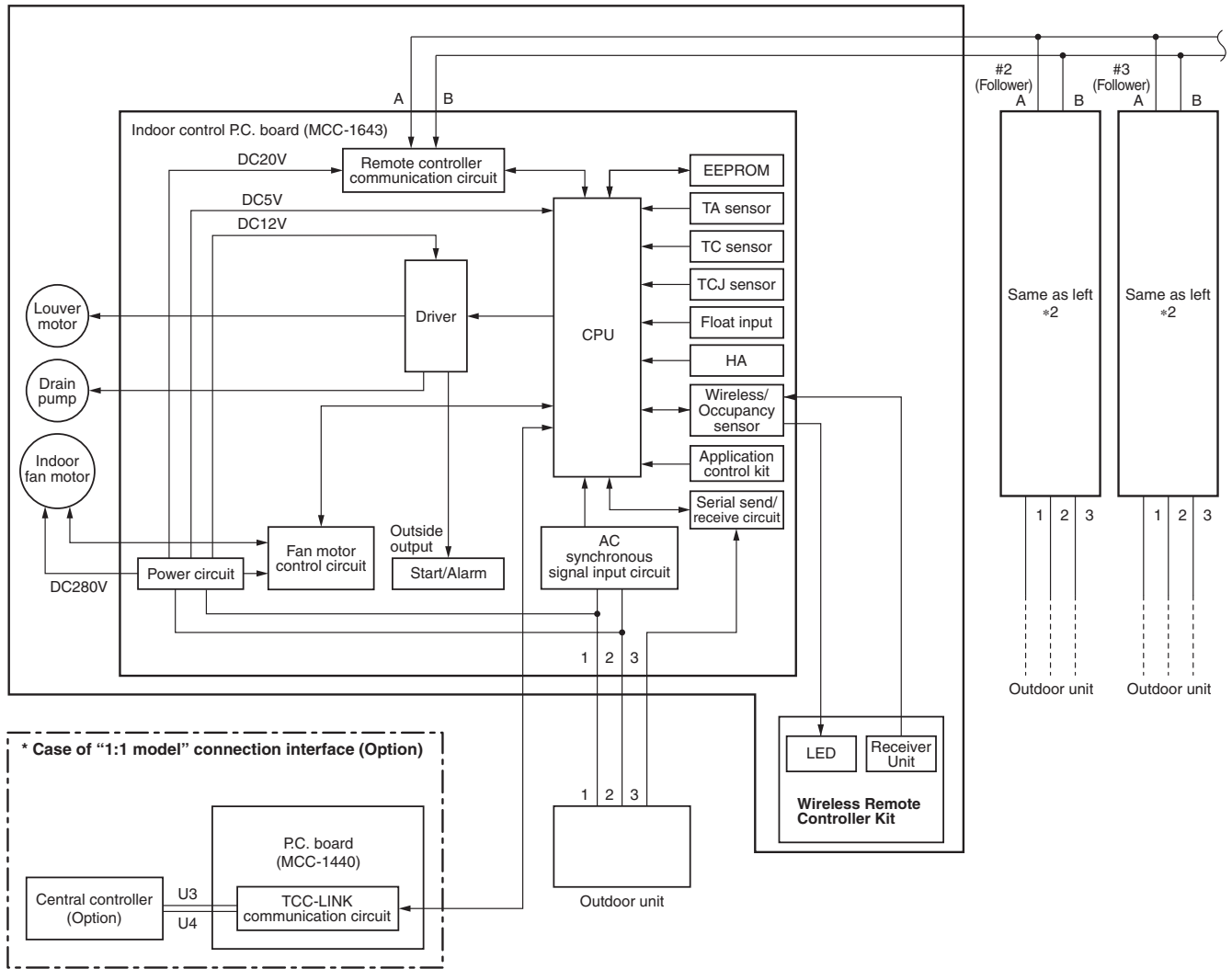

Up to 8 units are connectable. 1

*1 However Max.8 units are connectable in case of mounting "1:1 model" connection interface when two wired (simple) remote controllers are connected.

*2 The "1:1 model" connection interface is mounted to only 1 unit. "1:1 model" connection interface is mounted to the header unit.

6-1-3. Connection of Both Wired (Simple) Remote Controller and Wireless Remote Controller Kit

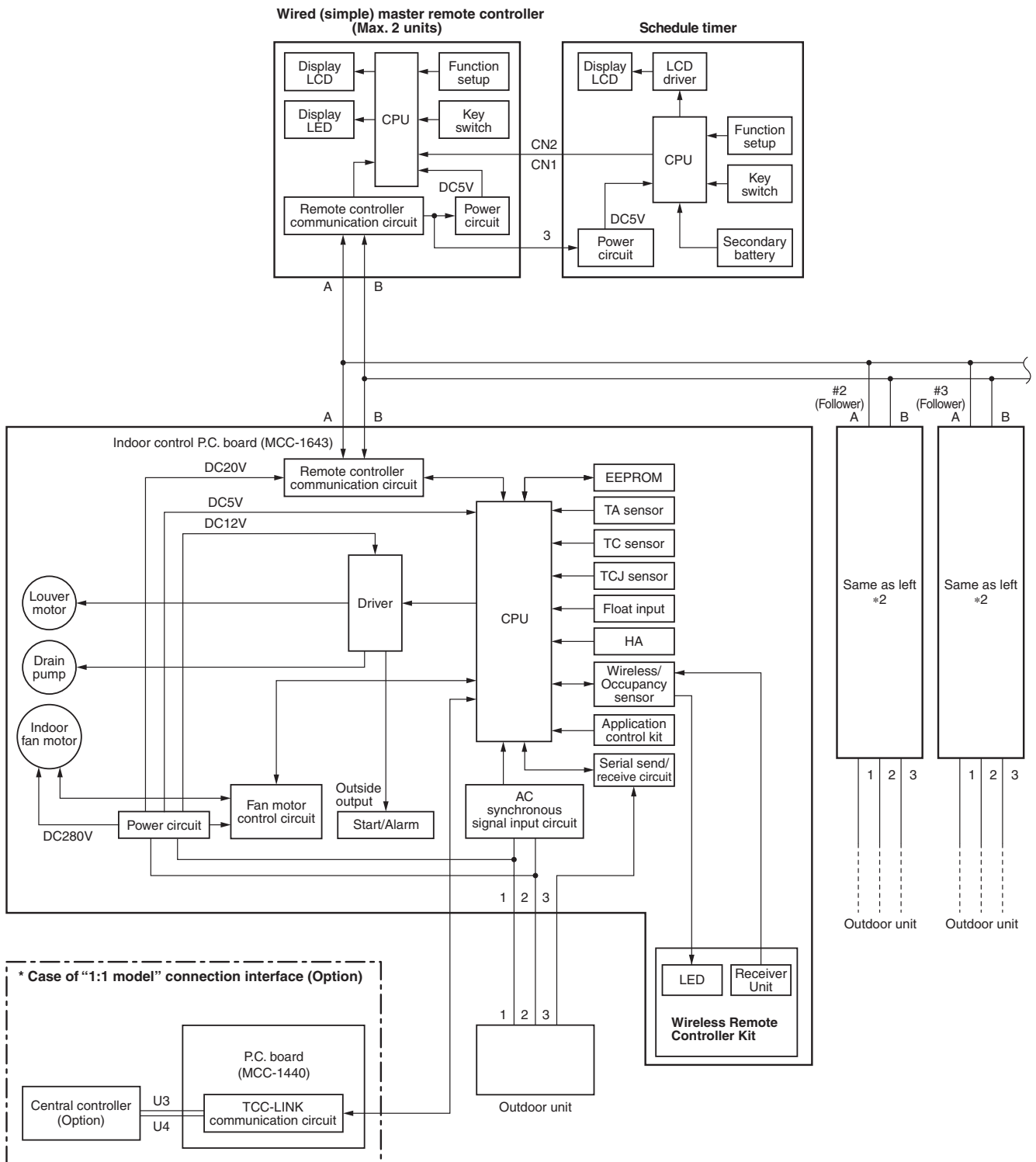

Up to 8 units are connectable. 1

- *1 However Max.8 units are connectable in case of mounting "1:1 model" connection interface.
- *2 The "1:1 model" connection interface is mounted to only 1 unit.
"1:1 model" connection interface is mounted to the header unit.
- *3 Connection of the schedule timer to the simple remote controller is unavailable.
- *4 In the left system, set the wireless remote controller side as the follower remote controller when using the wired (simple) wired remote controller as the header remote controller.



6-2. Control Specifications

No.	Item	Outline of specifications	Remarks																										
1	When power supply is reset	<p>1) Distinction of outdoor unit When the power supply is reset, the outdoors are distinguished and the control is selected according to the distinguished result.</p> <p>2) Setting of indoor fan speed and existence of air direction adjustment Based on EEPROM data, select setting of the indoor fan speed and the existence of air direction adjustment.</p>	Air speed (rpm)/ Air direction adjustment																										
2	Operation mode selection	<p>1) Based on the operation mode selecting command from the remote controller, the operation mode is selected.</p> <table border="1" style="width: 100%; border-collapse: collapse;"> <thead> <tr> <th style="text-align: center;">Remote controller command</th> <th style="text-align: center;">Control outline</th> </tr> </thead> <tbody> <tr> <td style="text-align: center;">STOP</td> <td>Air conditioner stops.</td> </tr> <tr> <td style="text-align: center;">FAN</td> <td>Fan operation</td> </tr> <tr> <td style="text-align: center;">COOL</td> <td>Cooling operation</td> </tr> <tr> <td style="text-align: center;">DRY</td> <td>Dry operation</td> </tr> <tr> <td style="text-align: center;">HEAT</td> <td>Heating operation</td> </tr> <tr> <td style="text-align: center;">AUTO</td> <td> <ul style="list-style-type: none"> • COOL/HEAT operation mode is automatically selected by Ta, Ts and To for operation. • The operation is performed as shown in the following figure according to Ta value at the first time only. (In the range of $T_s + \alpha - 1 < T_a < T_s + \alpha + 1$, Cooling thermo. OFF (Fan)/Setup air volume operation continues.) <div style="text-align: center;"> </div> <ul style="list-style-type: none"> • α is corrected according to the outside temperature. <table border="1" style="width: 100%; border-collapse: collapse; margin-top: 10px;"> <thead> <tr> <th style="text-align: center;">Outside temp.</th> <th style="text-align: center;">Correction value (α)</th> </tr> </thead> <tbody> <tr> <td style="text-align: center;">TO Nothing</td> <td style="text-align: center;">0K</td> </tr> <tr> <td style="text-align: center;">$T_o \geq 24^\circ\text{C}$</td> <td style="text-align: center;">-1K</td> </tr> <tr> <td style="text-align: center;">$24 > T_o \geq 18^\circ\text{C}$</td> <td style="text-align: center;">0K</td> </tr> <tr> <td style="text-align: center;">$T_o < 18^\circ\text{C}$</td> <td style="text-align: center;">+1K</td> </tr> <tr> <td style="text-align: center;">To Trouble</td> <td style="text-align: center;">0K</td> </tr> </tbody> </table> </td> </tr> </tbody> </table>	Remote controller command	Control outline	STOP	Air conditioner stops.	FAN	Fan operation	COOL	Cooling operation	DRY	Dry operation	HEAT	Heating operation	AUTO	<ul style="list-style-type: none"> • COOL/HEAT operation mode is automatically selected by Ta, Ts and To for operation. • The operation is performed as shown in the following figure according to Ta value at the first time only. (In the range of $T_s + \alpha - 1 < T_a < T_s + \alpha + 1$, Cooling thermo. OFF (Fan)/Setup air volume operation continues.) <div style="text-align: center;"> </div> <ul style="list-style-type: none"> • α is corrected according to the outside temperature. <table border="1" style="width: 100%; border-collapse: collapse; margin-top: 10px;"> <thead> <tr> <th style="text-align: center;">Outside temp.</th> <th style="text-align: center;">Correction value (α)</th> </tr> </thead> <tbody> <tr> <td style="text-align: center;">TO Nothing</td> <td style="text-align: center;">0K</td> </tr> <tr> <td style="text-align: center;">$T_o \geq 24^\circ\text{C}$</td> <td style="text-align: center;">-1K</td> </tr> <tr> <td style="text-align: center;">$24 > T_o \geq 18^\circ\text{C}$</td> <td style="text-align: center;">0K</td> </tr> <tr> <td style="text-align: center;">$T_o < 18^\circ\text{C}$</td> <td style="text-align: center;">+1K</td> </tr> <tr> <td style="text-align: center;">To Trouble</td> <td style="text-align: center;">0K</td> </tr> </tbody> </table>	Outside temp.	Correction value (α)	TO Nothing	0K	$T_o \geq 24^\circ\text{C}$	-1K	$24 > T_o \geq 18^\circ\text{C}$	0K	$T_o < 18^\circ\text{C}$	+1K	To Trouble	0K	<p>Ta: Room temp. Ts: Setup temp. To: Outside temp.</p> <p style="text-align: right;">k = deg</p>
Remote controller command	Control outline																												
STOP	Air conditioner stops.																												
FAN	Fan operation																												
COOL	Cooling operation																												
DRY	Dry operation																												
HEAT	Heating operation																												
AUTO	<ul style="list-style-type: none"> • COOL/HEAT operation mode is automatically selected by Ta, Ts and To for operation. • The operation is performed as shown in the following figure according to Ta value at the first time only. (In the range of $T_s + \alpha - 1 < T_a < T_s + \alpha + 1$, Cooling thermo. OFF (Fan)/Setup air volume operation continues.) <div style="text-align: center;"> </div> <ul style="list-style-type: none"> • α is corrected according to the outside temperature. <table border="1" style="width: 100%; border-collapse: collapse; margin-top: 10px;"> <thead> <tr> <th style="text-align: center;">Outside temp.</th> <th style="text-align: center;">Correction value (α)</th> </tr> </thead> <tbody> <tr> <td style="text-align: center;">TO Nothing</td> <td style="text-align: center;">0K</td> </tr> <tr> <td style="text-align: center;">$T_o \geq 24^\circ\text{C}$</td> <td style="text-align: center;">-1K</td> </tr> <tr> <td style="text-align: center;">$24 > T_o \geq 18^\circ\text{C}$</td> <td style="text-align: center;">0K</td> </tr> <tr> <td style="text-align: center;">$T_o < 18^\circ\text{C}$</td> <td style="text-align: center;">+1K</td> </tr> <tr> <td style="text-align: center;">To Trouble</td> <td style="text-align: center;">0K</td> </tr> </tbody> </table>	Outside temp.	Correction value (α)	TO Nothing	0K	$T_o \geq 24^\circ\text{C}$	-1K	$24 > T_o \geq 18^\circ\text{C}$	0K	$T_o < 18^\circ\text{C}$	+1K	To Trouble	0K																
Outside temp.	Correction value (α)																												
TO Nothing	0K																												
$T_o \geq 24^\circ\text{C}$	-1K																												
$24 > T_o \geq 18^\circ\text{C}$	0K																												
$T_o < 18^\circ\text{C}$	+1K																												
To Trouble	0K																												
3	Room temp. control	<p>1) Adjustment range: Remote controller setup temperature ($^\circ\text{C}$)</p> <table border="1" style="width: 100%; border-collapse: collapse; margin-top: 10px;"> <thead> <tr> <th></th> <th style="text-align: center;">COOL/DRY</th> <th style="text-align: center;">HEAT</th> <th style="text-align: center;">AUTO</th> </tr> </thead> <tbody> <tr> <td style="text-align: center;">Wired type</td> <td style="text-align: center;">18 to 29</td> <td style="text-align: center;">18 to 29</td> <td style="text-align: center;">18 to 29</td> </tr> <tr> <td style="text-align: center;">Wireless type</td> <td style="text-align: center;">17 to 30</td> <td style="text-align: center;">17 to 30</td> <td style="text-align: center;">17 to 30</td> </tr> </tbody> </table>		COOL/DRY	HEAT	AUTO	Wired type	18 to 29	18 to 29	18 to 29	Wireless type	17 to 30	17 to 30	17 to 30															
	COOL/DRY	HEAT	AUTO																										
Wired type	18 to 29	18 to 29	18 to 29																										
Wireless type	17 to 30	17 to 30	17 to 30																										

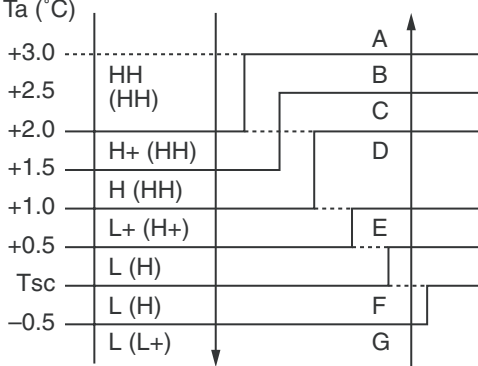
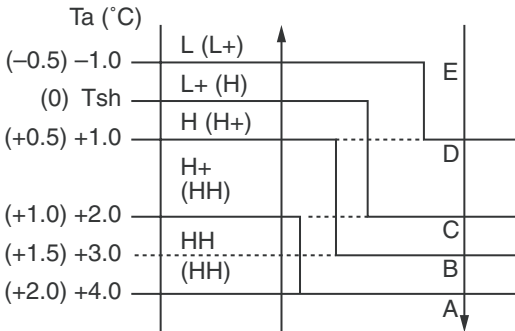

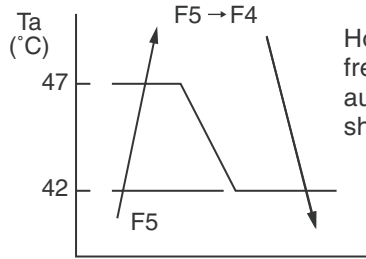

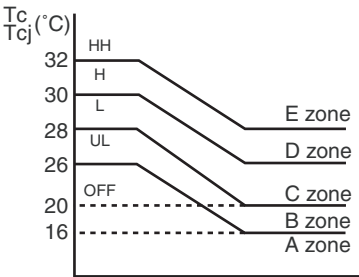
No.	Item	Outline of specifications	Remarks												
3	Room temp. control (Continued)	2) Using the Item code 06, the setup temperature in heating operation can be corrected. <table border="1" data-bbox="443 286 1096 369"> <thead> <tr> <th>Setup data</th> <th>0</th> <th>2</th> <th>4</th> <th>6</th> </tr> </thead> <tbody> <tr> <td>Setup temp. correction</td> <td>+0°C</td> <td>+2°C</td> <td>+4°C</td> <td>+6°C</td> </tr> </tbody> </table> Setting at shipment <table border="1" data-bbox="443 427 732 470"> <tbody> <tr> <td>Setup data</td> <td>2</td> </tr> </tbody> </table>	Setup data	0	2	4	6	Setup temp. correction	+0°C	+2°C	+4°C	+6°C	Setup data	2	Shift of suction temperature in heating operation
Setup data	0	2	4	6											
Setup temp. correction	+0°C	+2°C	+4°C	+6°C											
Setup data	2														
4	Automatic capacity control (GA control)	1) Based on the difference between T_a and T_s , the operation frequency is instructed to the outdoor unit. 2) Cooling operation Every 90 seconds, the room temperature difference between temperature detected by T_a and T_s and the varied room temperature value are calculated to obtain the correction value of the frequency command and then the present frequency command is corrected. $T_a(n) - T_s(n)$: Room temp. difference n : Counts of detection $T_a(n-1) - T_s(n)$: Varied room temp. value $n - 1$: Counts of detection of 90 seconds before 3) Heating operation Every 1 minute (60 sec.), the room temperature difference between temperature detected by T_a and T_s and the varied room temperature value are calculated to obtain the correction value of the frequency command and then the present frequency command is corrected. $T_s(n) - T_a(n)$: Room temp. difference n : Counts of detection $T_a(n) - T_a(n - 1)$: Varied room temp. value $n - 1$: Counts of detection of 1 minute before 4) Dry operation The frequency correction control is same as those of the cooling operation. However the maximum frequency is limited to approximately "S6". Note) When LOW is set up, the maximum frequency is limited to approximately "SB".													
5	Automatic cooling/heating control	1) The judgment of selecting COOL/HEAT is carried out as shown below. When +1.5 exceeds against T_{sh} 10 minutes and after thermo.-OFF, heating operation (Thermo. OFF) exchanges to cooling operation. Description in the parentheses shows an example of cooling ON/OFF. <div data-bbox="571 1624 970 1825" style="text-align: center;"> </div> When -1.5 lowers against T_{sc} 10 minutes and after thermo. OFF, cooling operation (Thermo. OFF) exchanges to heating operation. 2) For the automatic capacity control after judgment of cooling/heating, see Item 4. 3) For temperature correction of room temp. control in automatic heating, see Item 3.	T_{sc} : Setup temp. in cooling operation T_{sh} : Setup temp. in heating operation + temp. correction of room temp. control												

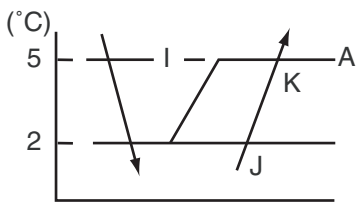

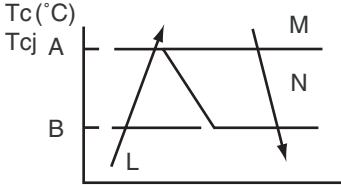

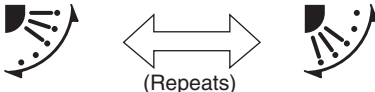
No.	Item	Outline of specifications	Remarks
6	Air speed selection	<p>1) Operation with (HH), (H+), (H), (L+) (L) or [AUTO] mode is carried out by the command from the remote controller.</p> <p>2) When the air speed mode [AUTO] is selected, the air speed varies by the difference between Ta and Ts.</p> <p><COOL></p>  <ul style="list-style-type: none"> • Controlling operation in case when thermo of remote controller works is same as a case when thermo of the body works. • If the air speed has been changed once, it is not changed for 3 minutes. However when the air volume is exchanged, the air speed changes. • When cooling operation has started, select a downward slope for the air speed, that is, the high position. • If the temperature is just on the difference boundary, the air speed does not change. • Mode in the parentheses indicates one in automatic cooling operation. <p><HEAT></p>  <p>Value in the parentheses indicates one when thermostat of the remote controller works. Value without parentheses indicates one when thermostat of the body works.</p> <ul style="list-style-type: none"> • If the air speed has been changed once, it is not changed for 1 minute. However when the air speed is exchanged, the air speed changes. • When heating operation has started, select an upward slope for the air speed, that is, the high position. • If the temperature is just on the difference boundary, the air speed does not change. • Mode in the parentheses indicates one in automatic heating operation. • In $T_c \geq 60^\circ\text{C}$, the air speed increases by 1 step. 	<p>HH > H+ > H > L+ > L > UL</p> <p>Tc: Indoor heat exchanger sensor temperature</p>

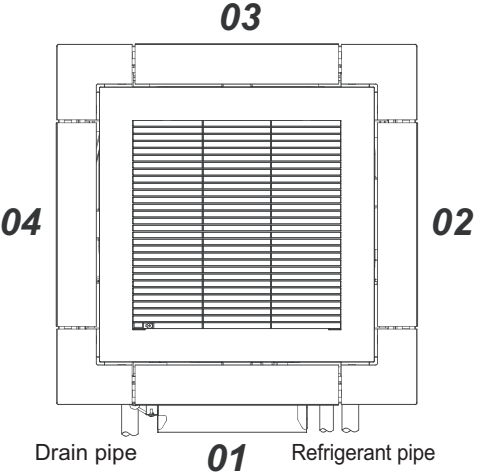

No.	Item	Outline of specifications	Remarks																																																																																																																
6	Air speed selection (Continued):	<p>* Only RM30 can not set up Type 1 and Type 3.</p> <table border="1" data-bbox="427 271 1155 846"> <thead> <tr> <th data-bbox="427 271 611 338">CODE No. [5d]</th> <th colspan="2" data-bbox="611 271 794 338">Standard 0000</th> <th colspan="2" data-bbox="794 271 978 338">Type 1* 0001</th> <th colspan="2" data-bbox="978 271 1155 338">Type 3* 0003</th> </tr> <tr> <th data-bbox="427 338 611 371">SW501 (1)/(2)</th> <th colspan="2" data-bbox="611 338 794 371">OFF/OFF</th> <th colspan="2" data-bbox="794 338 978 371">ON/OFF</th> <th colspan="2" data-bbox="978 338 1155 371">OFF/ON</th> </tr> <tr> <th data-bbox="427 371 611 405">Tap</th> <th data-bbox="611 371 699 405">COOL</th> <th data-bbox="699 371 794 405">HEAT</th> <th data-bbox="794 371 882 405">COOL</th> <th data-bbox="882 371 978 405">HEAT</th> <th data-bbox="978 371 1066 405">COOL</th> <th data-bbox="1066 371 1155 405">HEAT</th> </tr> </thead> <tbody> <tr><td data-bbox="427 405 611 439">F1</td><td></td><td></td><td></td><td></td><td>HH</td><td>HH</td></tr> <tr><td data-bbox="427 439 611 472">F2</td><td></td><td></td><td>HH</td><td>HH</td><td></td><td></td></tr> <tr><td data-bbox="427 472 611 506">F3</td><td></td><td></td><td></td><td>H+</td><td>H+, H</td><td>H+, H</td></tr> <tr><td data-bbox="427 506 611 539">F4</td><td></td><td></td><td>H+</td><td></td><td></td><td></td></tr> <tr><td data-bbox="427 539 611 573">F5</td><td></td><td>HH</td><td></td><td>H</td><td></td><td></td></tr> <tr><td data-bbox="427 573 611 607">F6</td><td>HH</td><td></td><td>H</td><td></td><td>L+</td><td>L+</td></tr> <tr><td data-bbox="427 607 611 640">F7</td><td>H+</td><td>H+</td><td></td><td></td><td>L</td><td>L</td></tr> <tr><td data-bbox="427 640 611 674">F8</td><td></td><td>H</td><td></td><td>L+</td><td></td><td></td></tr> <tr><td data-bbox="427 674 611 707">F9</td><td>H</td><td></td><td>L+</td><td>L</td><td></td><td></td></tr> <tr><td data-bbox="427 707 611 741">FA</td><td></td><td>L+</td><td>L</td><td></td><td></td><td></td></tr> <tr><td data-bbox="427 741 611 775">FB</td><td>L+</td><td>L</td><td></td><td></td><td></td><td></td></tr> <tr><td data-bbox="427 775 611 808">FC</td><td>L</td><td></td><td></td><td></td><td></td><td></td></tr> <tr><td data-bbox="427 808 611 842">FD</td><td>LL</td><td>LL</td><td>LL</td><td>LL</td><td>LL</td><td>LL</td></tr> </tbody> </table> <p data-bbox="427 891 1155 947">3) In heating operation, the mode changes to [UL] if thermostat is turned off.</p> <p data-bbox="427 958 1155 1104">4) If $T_a \geq 25^\circ\text{C}$ when heating operation has started and when defrost operation has been cleared, the air conditioner operates with (H) mode or higher mode for 1 minute after T_c entered in E zone of cool air discharge preventive control (Item 7).</p> <p data-bbox="427 1115 1155 1205">5) In automatic cooling/heating operation, the revolution frequency of (HH) is set larger than that in the standard cooling/heating operation.</p> <div data-bbox="459 1227 1155 1485">  <p data-bbox="798 1249 1155 1373">However the revolution frequency is restricted in the automatic heating operation as shown in the following figure.</p> </div>	CODE No. [5d]	Standard 0000		Type 1* 0001		Type 3* 0003		SW501 (1)/(2)	OFF/OFF		ON/OFF		OFF/ON		Tap	COOL	HEAT	COOL	HEAT	COOL	HEAT	F1					HH	HH	F2			HH	HH			F3				H+	H+, H	H+, H	F4			H+				F5		HH		H			F6	HH		H		L+	L+	F7	H+	H+			L	L	F8		H		L+			F9	H		L+	L			FA		L+	L				FB	L+	L					FC	L						FD	LL	LL	LL	LL	LL	LL	<p data-bbox="1185 253 1457 409">Selection of high ceiling type CODE No. : [5d] or selection of high ceiling on P.C. board SW501</p> <p data-bbox="1185 1115 1457 1238">However only when the high ceiling selection is set to [Standard]</p>
CODE No. [5d]	Standard 0000		Type 1* 0001		Type 3* 0003																																																																																																														
SW501 (1)/(2)	OFF/OFF		ON/OFF		OFF/ON																																																																																																														
Tap	COOL	HEAT	COOL	HEAT	COOL	HEAT																																																																																																													
F1					HH	HH																																																																																																													
F2			HH	HH																																																																																																															
F3				H+	H+, H	H+, H																																																																																																													
F4			H+																																																																																																																
F5		HH		H																																																																																																															
F6	HH		H		L+	L+																																																																																																													
F7	H+	H+			L	L																																																																																																													
F8		H		L+																																																																																																															
F9	H		L+	L																																																																																																															
FA		L+	L																																																																																																																
FB	L+	L																																																																																																																	
FC	L																																																																																																																		
FD	LL	LL	LL	LL	LL	LL																																																																																																													

No.	Item	Outline of specifications	Remarks
7	Cool air discharge preventive control	<p>1) In heating operation, the indoor fan is controlled based on the detected temperature of Tc sensor or Tcj sensor. As shown below, the upper limit of the revolution frequency is restricted.</p> <p>However B zone is assumed as C zone for 6 minutes and after when the compressor activated.</p> <p>In defrost operation, the control value of Tc is shifted by 6°C.</p> 	<p>In D and E zones, the priority is given to air volume selection setup of remote controller.</p> <p>In A zone while thermo is ON, [PRE-HEAT  (Heating ready)] is displayed.</p> <p>Tcj: Indoor heat exchanger sensor temperature</p>
8	Freeze preventive control (Low temperature release)	<p>1) The cooling operation (including Dry operation) is performed as follows based on the detected temperature of Tc sensor or Tcj sensor.</p> <p>When [J] zone is detected for 6 minutes (Following figure), the commanded frequency is decreased from the real operation frequency.</p> <p>After then the commanded frequency changes every 30 seconds while operation is performed in [J] zone.</p> <p>In [K] zone, time counting is interrupted and the operation is held.</p> <p>When [I] zone is detected, the timer is cleared and the operation returns to the normal operation.</p> <p>If the commanded frequency becomes S0 because the operation continues in [J] zone, the return temperature A is raised from 5°C to 12°C until [I] zone is detected and the indoor fan operates with [L] mode.</p>  <p>In heating operation, the freeze-preventive control works if 4-way valve is not exchanged and the following conditions are satisfied. (However the temperature for J zone dashing control is changed from 2°C to -5°C.)</p> <p><Conditions></p> <ul style="list-style-type: none"> • When ① or ② is established 5 minutes after activation. ① $T_{cn} \leq T_c(n-1) - 5$ ② $T_{cn} < T_c(n-1) - 1$ and $T_{cn} \leq T_a < 5^\circ\text{C}$ 	<p>Tcj: Indoor heat exchanger sensor temperature</p> <p>Tcn: Tc temperature when 5 minutes elapsed after activation</p> <p>Tc (n - 1): Tc temperature at start time</p>

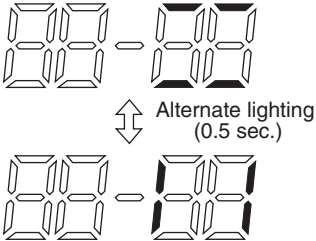
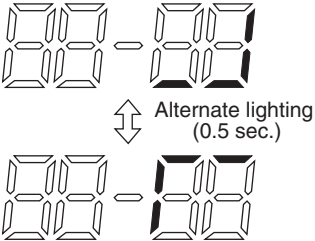

No.	Item	Outline of specifications	Remarks											
9	High-temp. release control	<p>1) The heating operation is performed as follows based on the detected temperature of Tc sensor or Tcj sensor.</p> <ul style="list-style-type: none"> • When [M] zone is detected, the commanded frequency is decreased from the real operation frequency. After then the commanded frequency changes every 30 seconds while operation is performed in [M] zone. • In [N] zone, the commanded frequency is held. • When [L] zone is detected, the commanded frequency is returned to the original value by approx. 6Hz every 60 seconds. <p>Setup at shipment</p> <table border="1" data-bbox="432 600 762 757"> <thead> <tr> <th rowspan="2">Refrigerant</th> <th colspan="2">Control temp. (°C)</th> </tr> <tr> <th>A</th> <th>B</th> </tr> </thead> <tbody> <tr> <td>R410A</td> <td>56 (54)</td> <td>52 (52)</td> </tr> <tr> <td>R32</td> <td>55 (53)</td> <td>51 (51)</td> </tr> </tbody> </table>  <p>NOTE: When the operation has started or when Tc or Tcj < 30°C at start of the operation or after operation start, temperature is controlled between values in parentheses of A and B.</p>	Refrigerant	Control temp. (°C)		A	B	R410A	56 (54)	52 (52)	R32	55 (53)	51 (51)	<p>However this control is ignored in case of the follower unit of the twin.</p> <p>Same status as that when “thermostat-OFF” (status that the air conditioner enters in the room temp. monitor mode when the temperature reached the setup temperature on the remote controller)</p>
Refrigerant	Control temp. (°C)													
	A	B												
R410A	56 (54)	52 (52)												
R32	55 (53)	51 (51)												
10	Drain pump control	<ol style="list-style-type: none"> 1) In cooling operation (including Dry operation), the drain pump is usually operated. 2) If the float switch works while drain pump drives, the compressor stops, the drain pump continues the operation, and a check code is output. 3) If the float switch works while drain pump stops, the compressor stops and the drain pump operates. If the float switch keeps operating for approx. 4 minutes, a check code is output. 4) The drain pump doesn't stop immediately to decrease the drain water in the drain pan when the cooling operation (including Dry operation) was stopped and drive the drain pump for five minutes. 	Check code [P10]											
11	After-heat elimination	When heating operation stops, in some cases, the indoor fan operates with (L) for approx. 30 seconds.												



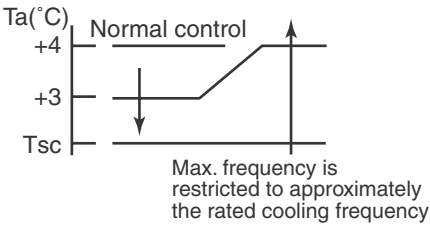
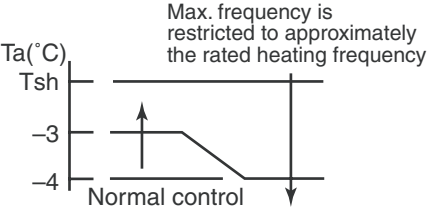

No.	Item	Outline of specifications	Remarks
12	Louver control	<p>1) Louver position setup</p> <ul style="list-style-type: none"> When the louver position is changed, the position moves necessarily to downward discharge position once to return to the set position. The louver position can be set up in the following operation range. <p>In cooling/dry operation In heating/fan operation</p>  <ul style="list-style-type: none"> In group twin/triple operation, the louver positions can be set up collectively or individually. <p>In case that HEAT refrigerant recovery control was performed in STOP status, the louver position becomes horizontal when the operation is resumed.</p> <p>2) Swing setup</p> <ul style="list-style-type: none"> [SWING] is displayed and the following display is repeated. <p>In all operations</p>  <ul style="list-style-type: none"> In group operation, the louver positions can be set up collectively or individually. <p>3) When the unit stopped or the warning was output, the louver is automatically set to full closed position.</p> <p>4) When PRE-HEAT (Heating ready) is displayed (Heating operation started or defrost operation is performed), heating thermo is off or self-cleaning is performed, the louver is automatically set to horizontal discharge position.</p> <p>* The louver which air direction is individually set or the locked louver closes fully when the unit stops and the louver is automatically set to horizontal discharge position when PRE-HEAT (Heating ready) is displayed, heating thermo is off.</p> <p><<Individual air direction setup>></p> <ul style="list-style-type: none"> Pushing  Louver select button enables every discharge port to set up the air direction. The louver numbers that are displayed on the display part correspond to those in the following figure. In case of no input (key operation) for approx. 5 seconds during setting of individual air direction (during displaying of louver No. on the remote controller screen), the remote controller screen returns to the normal display screen. For the air direction illustration during normal operation, the air direction of the least No. among the louvers which are block-set is displayed. While individual air direction is being set, the remote controller operation (Illustration of air direction) and operation of the real machine are linked. When selecting a case,  Louver select button is not pushed or louver No. is not displayed, the air directions of all the louvers are collectively set up. 	<p>The swinging louver moves usually up to the ceiling side from the louver position of the set time.</p> <p>Setup from the remote controller without  button is unavailable.</p> 

No.	Item	Outline of specifications	Remarks												
12	Louver control (Continued)	<p><<Selection of Swing mode>></p> <ul style="list-style-type: none"> For the Swing mode, the following three types of modes are selectable and settable by keeping Swing/Direction  button pushed for 4 seconds or more on the remote controller. <ol style="list-style-type: none"> Standard (4 pieces: same phase) swing → Data: [0001 (At shipment)] When Swing operation is selected, four louvers align at the horizontal discharge position and then start the Swing operation at the same time. Dual swing → Data: [0002] When operation is selected, the louvers of louver No. [01] and [03] move to the horizontal discharge position, the louvers of louver No. [02] and [04] move to the downward discharge position and then start the Swing operation at the same time. Cycle swing → Data: [0003] When operation is selected, the louver No. [01] moves to the horizontal discharge position, [03] to the downward discharge position, [02] and [04] to the middle position and then start the Swing operation at the same time. <ul style="list-style-type: none"> Three types of the swing modes can be also selected and set by the setup data of Item code (DN) [F0]. In case of selecting the Swing mode, “Dual swing” or “Cycle swing”, the following numerals is displayed at the center of the remote controller screen for approx. 3 seconds when  button was pushed to select [SWING]. (No display for the standard swing) <div style="display: flex; justify-content: space-around; align-items: center;"> <div style="text-align: center;">  <p>↑↓ Alternate lighting (0.5 sec.)</p> <p>Dual swing</p> </div> <div style="text-align: center;">  <p>↑↓ Alternate lighting (0.5 sec.)</p> <p>Cycle swing</p> </div> </div> <p><<Louver lock (Louver fix)>></p> <ul style="list-style-type: none"> For the air direction setup for each discharge port, the louver position can be locked during the normal operation. An arbitrary air direction of an arbitrary louver can be registered and set by keeping  button pushed for 4 seconds or more on the remote controller. The louver lock can be set by registering the setup data to Item code (DN) [F1] to [F4] according to the following table. <table border="1" data-bbox="448 1879 1102 2051"> <thead> <tr> <th>Item code</th> <th>Objective louver No.</th> <th>Setup data</th> </tr> </thead> <tbody> <tr> <td>F1</td> <td>01</td> <td rowspan="4">0000: Release (At shipment) 0001: Horizontal discharge position ~ 0005: Downward discharge position</td> </tr> <tr> <td>F2</td> <td>02</td> </tr> <tr> <td>F3</td> <td>03</td> </tr> <tr> <td>F4</td> <td>04</td> </tr> </tbody> </table>	Item code	Objective louver No.	Setup data	F1	01	0000: Release (At shipment) 0001: Horizontal discharge position ~ 0005: Downward discharge position	F2	02	F3	03	F4	04	<p>Carry out setting operation during stop of the unit; otherwise the unit stops operation.</p> <p>Carry out setting operation during stop of the unit; otherwise the unit stops operation.</p>
Item code	Objective louver No.	Setup data													
F1	01	0000: Release (At shipment) 0001: Horizontal discharge position ~ 0005: Downward discharge position													
F2	02														
F3	03														
F4	04														

No.	Item	Outline of specifications	Remarks																		
12	Louver control (Continued)	<ul style="list-style-type: none"> • If there is the locked louver in the unit, [] goes on the remote controller screen. • While the following controls are performed, the louvers operate even if executing the louver lock. <table border="1" data-bbox="475 360 1161 600" style="width: 100%; border-collapse: collapse; text-align: center;"> <thead> <tr> <th style="width: 5%;"></th> <th style="width: 60%;">Control which ignores lock</th> <th style="width: 35%;">Objective louver No.</th> </tr> </thead> <tbody> <tr> <td>①</td> <td>Operation stop</td> <td>Full-close position</td> </tr> <tr> <td>②</td> <td>When heating operation started</td> <td>Horizontal discharge position</td> </tr> <tr> <td>③</td> <td>Heating thermo. OFF</td> <td>Horizontal discharge position</td> </tr> <tr> <td>④</td> <td>During defrost operation</td> <td>Horizontal discharge position</td> </tr> <tr> <td>⑤</td> <td>Initialize operation</td> <td>Full-close position</td> </tr> </tbody> </table> <ul style="list-style-type: none"> • The real louver corresponding to the louver No. displayed on the remote controller screen during setting of louver lock operates swinging. 		Control which ignores lock	Objective louver No.	①	Operation stop	Full-close position	②	When heating operation started	Horizontal discharge position	③	Heating thermo. OFF	Horizontal discharge position	④	During defrost operation	Horizontal discharge position	⑤	Initialize operation	Full-close position	<p>For the setting operation, refer to [How to set louver lock] of Installation Manual.</p> <p>It is position check operation and it does not link with the real louver and air direction setup (Illustration on the remote controller screen).</p>
	Control which ignores lock	Objective louver No.																			
①	Operation stop	Full-close position																			
②	When heating operation started	Horizontal discharge position																			
③	Heating thermo. OFF	Horizontal discharge position																			
④	During defrost operation	Horizontal discharge position																			
⑤	Initialize operation	Full-close position																			
13	HA control	<ol style="list-style-type: none"> 1) This control is connected to TV control or remote start/stop I/F, etc, and start/stop are available by HA signal input from the remote position. 2) This control outputs start/stop status to HA output terminal. 3) I/O specifications conform to JEMA regulations. 4) This control outputs [Operation OFF (STOP) signal] to HA output terminal while self-cleaning works. However selection of [Operation ON (Operating) signal] is possible by changing [0000 (At shipment)] of Item code (DN) [CC] to [0001]. In this case, if HA is input during self-clean operation during operation of the air conditioner, the self-clean operation is not performed. (Unit stops.) 	<p>In the group operation, use this control by connecting to either header or follower indoor unit.</p>																		
14	Frequency fixed operation (Test run)	<p>Refer to "9-1-1. Test Run Setup on Remote Controller"</p>	<p>Command frequency is approximately [S7]</p>																		
15	Filter sign display (Except wireless type)	<ol style="list-style-type: none"> 1) The operation time of the indoor fan is calculated, the filter reset signal is sent to the remote controller when the specified time (2500H) has passed, and it is displayed on LCD. 2) When the filter reset signal has been received from the remote controller, time of the calculation timer is cleared. In this case, the measurement time is reset if the specified time has passed, and display on LCD disappears. 	<p>[FILTER ] goes on.</p>																		

No.	Item	Outline of specifications	Remarks
16	Central control mode selection	1) Setting at the central controller side enables to select the contents which can be operated on the remote controller at indoor unit side. * In case of the wireless type, the display lamp does not change but the contents are same. If operating an item which is prohibited by the central control mode from the remote controller, it is notified with the receive sound, Pi, Pi, Pi, Pi, Pi (5 times).	
17	Energy saving operation	1) When the "Energy saving operation" is selected during AUTO mode, energy-saving operation will be carried out. (In RBC-AMS55E*, COOL and HEAT mode can also be selected.) 2) The setup temperature is shifted (corrected) in the range not to lose the comfort ability according to input values of various sensors. 3) Data (Input value room temp. Ta, Outside temp. To, Air volume, Indoor heat exchanger sensor temp. Tc) for 20 minutes are taken the average to calculate correction value of the setup temperature. 4) The setup temperature is shifted every 20 minutes, and the shifted range is as follows. In cooling time: +1.5 to -1.0K In heating time: -1.5 to +1.0K	Wireless remote control (RBC-AMS55E*) is required.
18	Max. frequency cut control	1) This control is operated by selecting [AUTO] operation mode. 2) COOL operation mode: It is controlled according to the following figure if $T_o < 28^{\circ}\text{C}$.  3) HEAT operation mode: It is controlled according to the following figure if $T_o > 15^{\circ}\text{C}$. 	

No.	Item	Outline of specifications	Remarks
19	DC motor	<p>1) When the fan operation has started, positioning of the stator and the rotor are performed. (Moves slightly with tap sound)</p> <p>2) The motor operates according to the command from the indoor controller.</p> <p>Notes)</p> <ul style="list-style-type: none"> • When the fan rotates while the air conditioner stops due to entering of outside air, etc, the air conditioner may operate while the fan motor stops. • When a fan lock is found, the air conditioner stops, and a trouble is displayed. 	Check code [P12]
20	Power saving	<p>1) Turn on  button on the remote controller.</p> <p>2) During operation of save operation,  lights on the wired remote controller.</p> <p>3) During power save operation, the current release control is performed with the restriction ratio set in EEPROM on the outdoor unit.</p> <p>4) The restriction ratio can be set by keeping  button pushed for 4 seconds or more on the remote controller.</p> <p>5) When validating the power save operation, the next operation starts with power save operation valid because contents are held even when operation stops, operation mode changes or power supply is reset.</p> <p>6) The restriction ratio can be set by changing the setup data of CODE No. (DN) [C2] in the range of 50 to 100% (every 1%, Setting at shipment: 75%).</p>	<p>Operation and display also are unavailable on the wired remote controller RBC-AMT31E and before.</p> <p>Carry out setting operation during stop of the unit; otherwise the unit stops operation.</p> <p>For the setup operation, refer to "Power saving mode" of Installation Manual.</p>
21	Drain pump delay operation	<p>When a cooling operation (including dry operation) is stopped, the drain pump continues operating for 5 minutes to reduce drain water in drain pan.</p>	

No.	Item	Outline of specifications	Remarks																		
22	8°C heating/ Frost protective operation	<p>1) This functional is intended for the cold latitudes and performs objective heating operation (8°C heating operation).</p> <p>2) This function is valid only for combination with the outdoor units</p> <p>3) Using the indoor DN code [D1] (1 bit), Valid/Invalid of this function is set up at the customer's side. * The setup by DN code is Invalid [0]/Valid [1] and Invalid [0] has been set at the shipment.</p> <p>4) This operation is the heating operation which sets 8°C as the setup temperature of the target.</p> <p>5) This function starts operation by pushing temperature button  during heating operation; besides by pushing  button for 4 seconds or more after temperature reached the minimum set temperature.</p> <p>6) To stop/release this operation, select and execute one from the following operations.</p> <p>① Push  button: Heating operation (18°C setting) continues.</p> <p>② Push [START/STOP] button: Air conditioner stops. (Heating 18°C operation at the next start)</p> <p>③ Push  : Other operation mode is selected and the operation continues.</p> <p>7) As the setup temperature is 8°C and the human heating is not targeted, the cold air discharge preventive control (Item 7) is made invalid to suppress the intermittent operation.</p> <p>8) The settings of the air direction and air volume are changeable during this operation.</p> <p>9) The indoor fan stops to protect the compressor for 2 minutes after start of heating operation (Thermo-ON) by this function.</p>	<p>In a group connection, if there is even one combination with other unit, "This function is not provided." is displayed.</p> <p>The setup temperature jumps from [18] to [8].</p>																		
23	Occupancy sensor	<p>1) During the Occupancy sensor operation (DN code: [B5] [0001] and [B6] [0002 to 0005]), when there is no people in the Occupancy sensor range, it is automatically switched to the operation for the absence.</p> <p>2) The Occupancy sensor operation can change by [DN code : B6] as follows, and operates according to the operation at absent time, if time or absence of the setting contents continues. However time counting starts after the room temperature is stabilized. (after for 30 minutes operation)</p> <table border="1" data-bbox="587 1541 1098 1675"> <thead> <tr> <th>DN [B6]</th> <th>Data</th> <th>Setting contents</th> </tr> </thead> <tbody> <tr> <td></td> <td>0000</td> <td>Invalid</td> </tr> <tr> <td></td> <td>0001 to 0005</td> <td>30 minutes to 150 minutes (30 minutes each)</td> </tr> </tbody> </table> <p>3) The operation at absent time can be changed by [DN code : B7].</p> <table border="1" data-bbox="587 1765 1098 1865"> <thead> <tr> <th>DN [B7]</th> <th>Data</th> <th>Operation at absent time</th> </tr> </thead> <tbody> <tr> <td></td> <td>0000</td> <td>Circulator</td> </tr> <tr> <td></td> <td>0001</td> <td>Operation stop</td> </tr> </tbody> </table> <p>4) If the operation at absent time stops during group operation, or absence is fixed in each system, the operation starts circular operation once, and then the operation stops when absence was determined on all group.</p>	DN [B6]	Data	Setting contents		0000	Invalid		0001 to 0005	30 minutes to 150 minutes (30 minutes each)	DN [B7]	Data	Operation at absent time		0000	Circulator		0001	Operation stop	<p>The Occupancy sensor can be set up by wired remote controller RBC-AMS55E*</p>
DN [B6]	Data	Setting contents																			
	0000	Invalid																			
	0001 to 0005	30 minutes to 150 minutes (30 minutes each)																			
DN [B7]	Data	Operation at absent time																			
	0000	Circulator																			
	0001	Operation stop																			

6-3. Indoor Print Circuit Board

<MCC-1643>

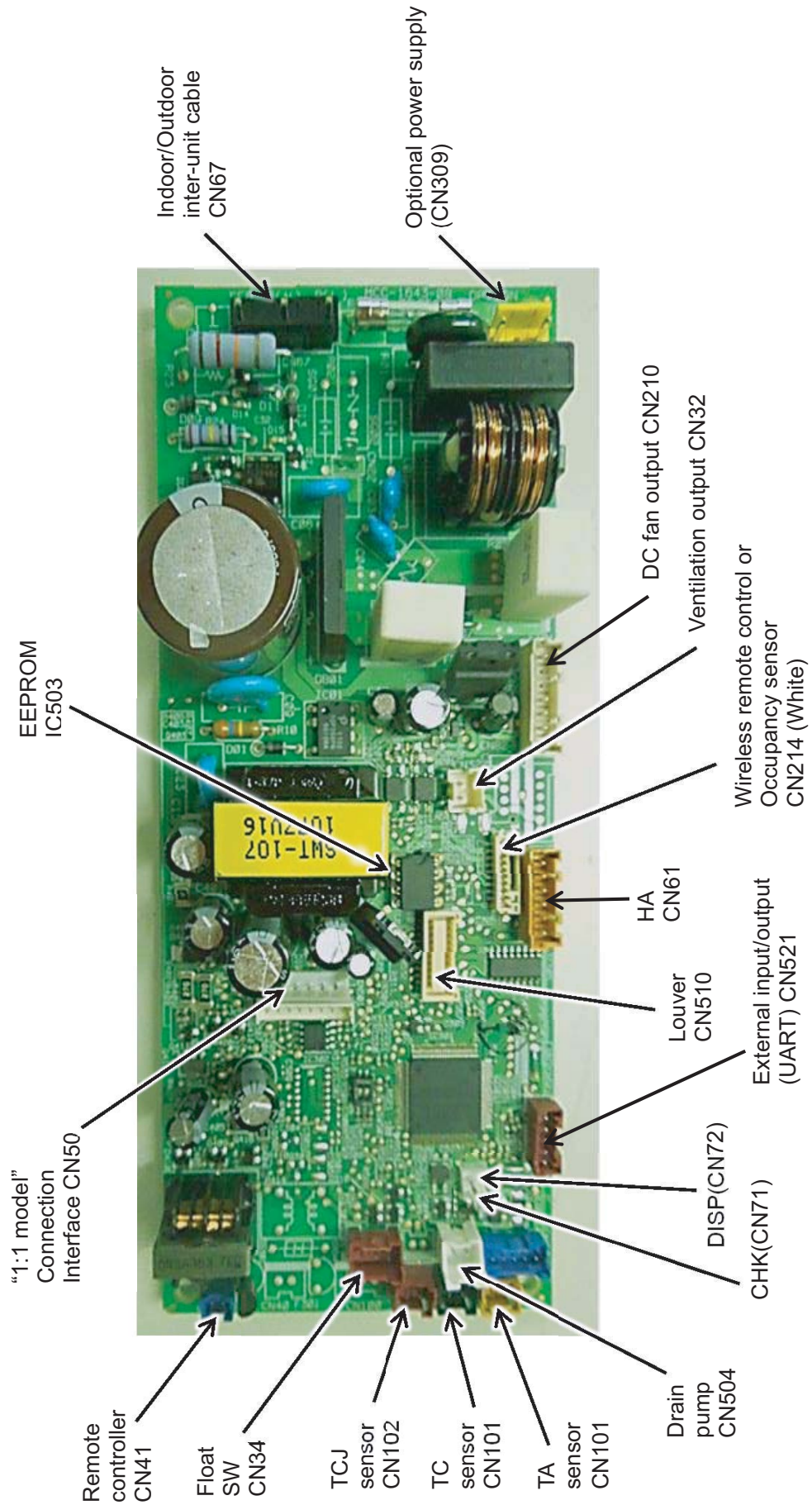

6-4. Optional connector specifications of indoor P.C. board

Function	Connector No.	Pin No.	Specifications	Remarks
Ventilation output	CN32	1	DC12V	Setting at shipment: Interlock of ON by indoor unit operation, with OFF by stop operation * The single operation setting by FAN button on the remote controller is performed on the remote controller (DN [31] = 0000 0001)
		2	Output (Open collector)	
HA	CN61	1	ON/OFF input	HA ON/OFF input (J01 : YES/NO=Pulse (At shipment from factory) /Static input selection)
		2	0V	
		3	Remote controller prohibited input	Permission/Prohibition of remote controller operation stop is performed by input.
		4	Operation output (Open collector)	
		5	DC12V	Operation ON (Answer back of HA)
		6	Warning output (Open collector)	
CHK Operation check	CN71	1	0V	This check is used to check indoor operation. (Performs operation of indoor fan "H", Louver horizontal and Drain pump ON without communication with outdoor and remote controller)
		2		
DISP Exhibition mode	CN72	1	0V	Communication is available by indoor unit and remote controller only.
		2		
Option control kit	CN521	1	12V	Connected Application control kit (TCB-PCUC1E-1)
		2	5V	
		3	Transmission	
		4	Receive	
		5	0V	
Occupancy sensor input	CN214	1	12V	Connect when using the Occupancy sensor. It is necessary to set the Occupancy sensor [B5] separately when using Occupancy sensor [B5] = "0000" "0001".
		2		
		3		
		4		
		5		
		6	GND	
		7	5V	
		8		
		9	Occupancy sensor input	

* As the functions operated by old CN60, CN80, CN70 and CN73 have been transported to the Application control kit (TCB-PCUC1E-1), you need to use them from the Application control kit (Sold separately)

7. TROUBLESHOOTING

7-1. Summary of Troubleshooting

<Wired remote controller type>

1. Before troubleshooting

1) Required tools/instruments

- ⊕ and ⊖ screwdrivers, spanners, radio cutting pliers, nippers, push pins for reset switch
- Tester, thermometer, pressure gauge, etc.

2) Confirmation points before check

a) The following operations are normal.

1. Compressor does not operate.

- Is not 3-minutes delay (3 minutes after compressor OFF)?
- Is not the outdoor unit in standby status though the remote controller reached the setup temperature?
- Does not timer operate during fan operation?
- Is not an overflow trouble detected on the indoor unit?
- Is not outside high-temperature operation controlled in heating operation?

2. Indoor fan does not rotate.

- Does not cool air discharge preventive control work in heating operation?

3. Outdoor fan does not rotate or air volume changes.

- Does not high-temperature release operation control work in heating operation?
- Does not outside low-temperature operation control work in cooling operation?
- Is not defrost operation performed?

4. ON/OFF operation cannot be performed from remote controller.

- Is not the control operation performed from outside/remote side?
- Is not automatic address being set up?
(When the power is turned on at the first time or when indoor unit address setting is changed, the operation cannot be performed for maximum approx. 5 minutes after power-ON.)
- Is not being carried out a test run by operation of the outdoor controller?

b) Did you return the cabling to the initial positions?

c) Are connecting cables of indoor unit and remote controller correct?

2. Troubleshooting procedure

When a trouble occurred, check the parts along with the following procedure.



NOTE :

For cause of a trouble, power conditions or malfunction/erroneous diagnosis of microcomputer due to outer noise is considered except the items to be checked. If there is any noise source, change the cables of the remote controller to shield cables.

<Wireless remote controller type>

1. Before troubleshooting

- 1) Required tools/instruments
 - ⊕ and ⊖ screwdrivers, spanners, radio cutting pliers, nippers, etc.
 - Tester, thermometer, pressure gauge, etc.
- 2) Confirmation points before check
 - a) The following operations are normal.
 1. Compressor does not operate.
 - Is not 3-minutes delay (3 minutes after compressor OFF)?
 - Is not the outdoor unit in standby status though the remote controller reached the setup temperature?
 - Does not timer operate during fan operation?
 - Is not an overflow trouble detected on the indoor unit?
 - Is not outside high-temperature operation controlled in heating operation?
 2. Indoor fan does not rotate.
 - Does not cool air discharge preventive control work in heating operation?
- 3) Outdoor fan does not rotate or air volume changes.
 - Does not high-temperature release operation control work in heating operation?
 - Does not outside low-temperature operation control work in cooling operation?
 - Is not defrost operation performed?
- 4) ON/OFF operation cannot be performed from remote controller.
 - Is not forced operation performed?
 - Is not the control operation performed from outside/remote side?
 - Is not automatic address being set up?
 - Is not being carried out a test run by operation of the outdoor controller?
 - a) Did you return the cabling to the initial positions?
 - b) Are connecting cables between indoor unit and receiving unit correct?

2. Troubleshooting procedure

(When the power is turned on at the first time or when indoor unit address setting is changed, the operation cannot be performed for maximum approx. 5 minutes after power-ON.)

When a trouble occurred, check the parts along with the following procedure.



1) Outline of judgment

The primary judgment to check where a trouble occurred in indoor unit or outdoor unit is performed with the following method.

Method to judge the erroneous position by flashing indication on the display part of indoor unit (sensors of the receiving unit)

The indoor unit monitors operating status of the air conditioner, and the blocked contents of self-diagnosis are displayed restricted to the following cases if a protective circuit works.

7-2. Troubleshooting

7-2-1. Outline of judgment

The primary judgment to check whether a trouble occurred in the indoor unit or outdoor unit is carried out with the following method.



Method to judge the erroneous position by flashing indication on the display part of the indoor unit (sensors of the receiving part)

The indoor unit monitors the operating status of the air conditioner, and the blocked contents of self-diagnosis are displayed restricted to the following cases if a protective circuit works.

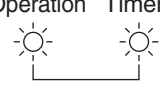
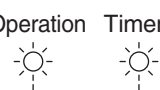
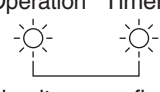
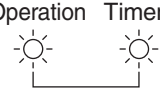

● : Go off, ○ : Go on, ◉ : Flash (0.5 sec.)

Lamp indication	Check code	Cause of trouble occurrence
Operation Timer Ready ● ● ● No indication at all	—	Power supply OFF or miswiring between receiving unit and indoor unit
Operation Timer Ready ◉ ● ● Flash	E01	Receiving trouble } Receiving unit } Sending trouble } Communication stop } Miswiring or wire connection trouble between receiving unit and indoor unit
	E02	
	E03	
	E08	Duplicated indoor unit No. } Duplicated header units of remote controller } Setup trouble
	E09	
	E11	Communication trouble between Application control kit and indoor unit P.C. board
E18	Wire connection trouble between indoor units, Indoor power OFF (Communication stop between indoor header and follower or between main and sub indoor twin)	
Operation Timer Ready ● ● ◉ Flash	E04	Miswiring between indoor unit and outdoor unit or connection trouble (Communication stop between indoor and outdoor units)
Operation Timer Ready ● ◉ ◉ Alternate flash	P10	Overflow was detected. } Indoor DC fan trouble } Protective device of indoor unit worked.
	P12	
Operation Timer Ready ◉ ● ◉ Alternate flash	P03	Outdoor unit discharge temp. trouble } Outdoor high pressure system trouble } Protective device of outdoor unit worked. *1
	P04	
	P05	Negative phase detection trouble } Heat sink overheat trouble } Gas leak detection trouble } Outdoor unit trouble
	P07	
	P15	
	P19	4-way valve system trouble (Indoor or outdoor unit judged.)
	P20	Outdoor unit high pressure protection
	P22	Outdoor unit: Outdoor unit trouble } Outdoor unit: Inverter Idc operation } Outdoor unit: Position detection trouble } Protective device of outdoor unit worked. *1
	P26	
P29		
P31	Stopped because of trouble of other indoor unit in a group (Check codes of E03/L03/L07/L08)	

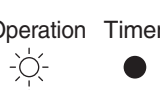
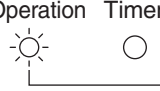
*1: These are representative examples and the check code differs according to the outdoor unit to be combined.

Lamp indication	Check code	Cause of trouble occurrence	
Operation Timer Ready  Alternate flash	F01	Heat exchanger sensor (TCJ) trouble } Indoor unit sensor trouble	
	F02		Heat exchanger sensor (TC) trouble
	F10		Heat exchanger sensor (TA) trouble
Operation Timer Ready  Alternate flash	F04	Sensor trouble of outdoor unit *1	
	F06		Temp. sensor (TE) trouble
	F07		Temp. sensor (TL) trouble
	F08		Temp. sensor (TO) trouble
	F12		Temp. sensor (TS) trouble
	F13		Temp. sensor (TH) trouble
	F15		Temp. Sensor miswiring (TE, TS)
Operation Timer Ready  Simultaneous flash	F29	Indoor EEPROM trouble	
Operation Timer Ready  Simultaneous flash	F30	Occupancy sensor trouble	
	F31	Outdoor EEPROM trouble	
Operation Timer Ready  Flash	H01	Outdoor compressor system trouble *1	
	H02		Compressor lock
	H03		Current detection circuit trouble
	H04		Case thermostat worked.
	H06		Outdoor unit low pressure system trouble
Operation Timer Ready  Simultaneous flash	L03	Duplicated header indoor units } → AUTO address * If group construction and address are not normal when power supply turned on, automatically goes to address setup mode.	
	L07		There is indoor unit of group connection in individual indoor unit.
	L08		Unsetting of group address
	L09		Missed setting (Unset indoor capacity)
Operation Timer Ready  Simultaneous flash	L10	Others	
	L20		Duplicated indoor central addresses
	L29		Outdoor unit and other trouble
	L30		Outside interlock trouble
	L31		Negative phase trouble

7-2-2. Others (Other than Check Code)

Lamp indication	Check code	Cause of trouble occurrence
Operation Timer Ready  Simultaneous flash	—	During test run
Operation Timer Ready  Alternate flash	—	Disagreement of cool/heat (Automatic cool/heat setting to automatic cool/heat prohibited model, or setting of heating to cooling-only model)

7-2-3. Check Code List (Indoor)

(Indoor unit detected) ○ : Go on, ◎ : Flash, ● : Go off ALT (Alternate): Alternate flashing when there are two flashing LED SIM (Simultaneous): Simultaneous flashing when there are two flashing LED

Check code indication TCC-LINK central & wired remote controller	Lamp indication			Representative defective position	Explanation of trouble contents	Air conditioner operation	
	Block indication Operation	Timer	Ready			Automatic reset	Operation continuation
E03	◎	●	●	Regular communication trouble between indoor and remote controller	No communication from remote controller and network adapter (Also no communication from central control system)	○	×
E04	◎	●	◎	Indoor/Outdoor serial trouble	There is trouble on serial communication between indoor and outdoor units	○	×
E08	◎	●	●	Duplicated indoor addresses	Same address as yours was detected.	○	×
E11	◎	●	●	Communication trouble between Application control kit and indoor unit	Communication trouble between Application control kit and indoor unit P.C. board	○	×
E18	◎	●	●	Regular communication trouble between indoor header and follower units	Regular communication between indoor header and follower units is impossible. Communication between twin header (main) and follower (sub) units is impossible.	○	×
F01	◎	◎	●	Indoor unit, Heat exchanger (TC-J) trouble	Open/short was detected on heat exchanger (TCJ).	○	×
F02	◎	◎	●	Indoor unit, Heat exchanger (TC) trouble	Open/short was detected on heat exchanger (TC).	○	×
F10	◎	◎	●	Indoor unit, Room temp. sensor (TA) trouble	Open/short was detected on room temp. sensor (TA).	○	×
F29	◎	◎	●	Indoor unit, other indoor P.C. board trouble	EEPROM trouble (Other trouble may be detected. If no trouble, automatic address is repeated.	×	×
F30	◎	◎	○	Occupancy sensor trouble	Occupancy sensor trouble has been detected.	○	○
L03	◎	◎	◎	Duplicated setting of indoor group header unit	There are multiple header units in a group.	×	×
L07	◎	◎	◎	There is group cable in individual indoor unit.	When even one group connection indoor unit exists in individual indoor unit.	×	×
L08	◎	◎	◎	Unset indoor group address	Indoor group address is unset.	×	×
L09	◎	◎	●	Unset indoor capacity	Capacity of indoor unit is unset.	×	×
L20	◎	○	◎	Duplicated central control system address	Duplicated setting of central control system address	○	×
L30	◎	○	◎	Outside trouble input to indoor unit (Interlock)	Abnormal stop by outside trouble (CN80) input	×	×
P01	◎	◎	◎	Indoor unit, AC fan trouble	An trouble of indoor AC fan was detected. (Fan motor thermal relay worked.)	×	×
P10	◎	◎	◎	Indoor unit, overflow detection	Flood switch worked.	×	×
P12	◎	◎	◎	Indoor unit, DC fan trouble	Indoor DC fan trouble (Over-current/Lock, etc.) was detected.	×	×
P19	◎	◎	◎	4-way valve system trouble	In heating operation, an trouble was detected by temp. down of indoor heat exchanger sensor.	○	×
P31	◎	◎	◎	Other indoor unit trouble	Follower unit in group cannot operate by warning from [E03/L03/L07/L08] of header unit.	○	×

◇ When this warning was detected before group construction/address check finish at power supply was turned on, the mode shifts automatically to AUTO address setup mode.

(Remote controller detected)

Check code indication Wired remote controller	Lamp indication			Representative defective position	Explanation of trouble contents	Air conditioner operation	
	Block indication Operation	Timer	Ready			Automatic reset	Operation continuation
E01	◎	●	●	No master remote controller, Remote controller communication (Receive) trouble	Signal cannot be received from indoor unit. Master remote controller was not set. (including 2 remote controllers)	—	—
E02	◎	●	●	Remote controller communication (Send) trouble	Signal cannot be sent to indoor unit.	—	—
E09	◎	●	●	Duplicated master remote controller	In 2-remote controller control, both were set as master. (Indoor master unit stops warning and follower unit continues operation.)	×	△

(Central control devices detected)

Check code indication TCC-LINK central	Lamp indication			Representative defective position	Explanation of trouble contents	Air conditioner operation	
	Block indication Operation	Timer	Ready			Automatic reset	Operation continuation
C05	Is not displayed (Common use of wired remote controller, etc.)	—	—	Central control system communication (send) trouble	Signal sending operation of central control system is impossible. There are multiple same central devices. (AI-NET)	—	—
C06	—	—	—	Central control system communication (receive) trouble	Signal receiving operation of central control system is impossible.	—	—
C12	—	—	—	General-purpose device control interface batched warning	An trouble on device connected to general-purpose device control interface of exclusive to TCC-LINK/AI-NET	—	—
P30	By warning unit (Above-mentioned)	—	—	Group follower unit is defective.	Group follower unit is defective. (For remote controller, above-mentioned [***] details are displayed with unit No.	—	—

NOTE: Even for the same contents of trouble such as communication trouble, the display of check code may differ according to detection device. When wired remote controller or central controller detects an trouble, it is not necessarily related to operation of the air conditioner. In this list, the check codes that outdoor unit detects are not described.

Trouble mode detected by indoor unit

Operation of diagnostic function				Judgment and measures
Check code	Cause of operation	Status of air conditioner	Condition	
E03	No communication from remote controller (including wireless) and communication adapter	Stop (Automatic reset)	Displayed when trouble is detected	1. Check cables of remote controller and communication adapters. Remote controller LCD display OFF (Disconnection) Central remote controller [97] check code
E04	The serial signal is not output from outdoor unit to indoor unit. • Miswiring of inter-unit wire • Defective serial sending circuit on outdoor P.C. board • Defective serial receiving circuit on indoor P.C. board	Stop (Automatic reset)	Displayed when trouble is detected	1. Outdoor unit does not completely operate. • Inter-unit wire check, correction of miswiring • Check outdoor P.C. board. Correct wiring of P.C. board. 2. When outdoor unit normally operates Check P.C. board (Indoor receiving / Outdoor sending).
E08	Duplicated indoor unit address	Stop	Displayed when trouble is detected	1. Check whether remote controller connection (Group/Individual) was changed or not after power supply turned on (Finish of group construction/Address check). * If group construction and address are not normal when the power has been turned on, the mode automatically shifts to address setup mode. (Resetting of address)
L03	Duplicated indoor header unit			
L07	There is group wire in individual indoor unit.			
L08	Unset indoor group address			
L09	Unset indoor capacity	Stop	Displayed when trouble is detected	1. Set indoor capacity (DN=11)
L30	Abnormal input of outside interlock	Stop	Displayed when trouble is detected	1. Check outside devices. 2. Check indoor P.C. board.
P10	Float switch operation • Float circuit, Disconnection, Coming-off, Float switch contact trouble	Stop	Displayed when trouble is detected	1. Trouble of drain pump 2. Clogging of drain pump 3. Check float switch. 4. Check Application control kit (TCB-PCUC1E-1)
P12	Indoor DC fan trouble	Stop	Displayed when trouble is detected	1. Position detection trouble 2. Check fan motor (Protective circuit operation). 3. Indoor fan locked. 4. Check indoor P.C. board.
P19	4-way valve system trouble • After heating operation has started, indoor heat exchangers temp. is down.	Stop (Automatic reset)	Displayed when trouble is detected	1. Check 4-way valve. 2. Check 2-way valve and check valve. 3. Check indoor heat exchanger (TC/TCJ). 4. Check indoor P.C. board.
P31	Own unit stops while warning is output to other indoor units.	Stop (Follower unit) (Automatic reset)	Displayed when trouble is detected	1. Judge follower unit while header unit is [E03], [L03], [L07] or [L08]. 2. Check indoor P.C. board.
F01	Coming-off, disconnection or short of indoor heat exchanger temp. sensor (TCJ)	Stop (Automatic reset)	Displayed when trouble is detected	1. Check indoor heat exchanger temp. sensor (TCJ). 2. Check indoor P.C. board.
F02	Coming-off, disconnection or short of indoor heat exchanger temp. sensor (TC)	Stop (Automatic reset)	Displayed when trouble is detected	1. Check indoor heat exchanger temp. sensor (TC). 2. Check indoor P.C. board.
F10	Coming-off, disconnection or short of indoor heat exchanger temp. sensor (TA)	Stop (Automatic reset)	Displayed when trouble is detected	1. Check indoor heat exchanger temp. sensor (TA). 2. Check indoor P.C. board.
F29	Indoor EEPROM trouble • EEPROM access trouble	Stop (Automatic reset)	Displayed when trouble is detected	1. Check indoor EEPROM. (including socket insertion) 2. Check indoor P.C. board.
E11	Communication trouble between Application control kit and indoor unit	Stop (Automatic reset)	Displayed when trouble is detected	1. Check power supply/communication harness. 2. Check indoor P.C. board.
F30	Occupancy sensor trouble	Operation	Displayed when trouble is detected	1. Check occupancy sensor wiring. 2. Check indoor P.C. board.
E18	Regular communication trouble between indoor aster and follower units and between main and sub units	Stop (Automatic reset)	Displayed when trouble is detected	1. Check remote controller wiring. 2. Check indoor power supply wiring. 3. Check indoor P.C. board.

Trouble mode detected by remote controller or central controller (TCC-LINK)

Operation of diagnostic function				Judgment and measures
Check code	Cause of operation	Status of air conditioner	Condition	
Not displayed at all (Operation on remote controller is impossible.)	No communication with header indoor unit <ul style="list-style-type: none"> Remote controller wiring is not correct. Power of indoor unit is not turned on. Automatic address cannot be completed. 	Stop	—	Power supply trouble of remote controller, Indoor EEPROM trouble <ol style="list-style-type: none"> Check remote controller inter-unit wiring. Check remote controller. Check indoor power wiring. Check indoor P.C. board. Check indoor EEPROM. (including socket insertion) Automatic address repeating phenomenon generates.
E01 2	No communication with header indoor unit <ul style="list-style-type: none"> Disconnection of inter-unit wire between remote controller and header indoor unit (Detected by remote controller side) 	Stop (Automatic reset) * If center exists, operation continues.	Displayed when trouble is detected	Receiving trouble from remote controller <ol style="list-style-type: none"> Check remote controller inter-unit wiring. Check remote controller. Check indoor power wiring. Check indoor P.C. board.
E02	Signal send trouble to indoor unit (Detected by remote controller side)	Stop (Automatic reset) * If center exists, operation continues.	Displayed when trouble is detected	Sending trouble of remote controller <ol style="list-style-type: none"> Check sending circuit inside of remote controller. → Replace remote controller.
E09	There are multiple main remote controllers. (Detected by remote controller side)	Stop (Follower unit continues operation.)	Displayed when trouble is detected	<ol style="list-style-type: none"> In 2-remote controllers (including wireless), there are multiple header units. Check that there are 1 main remote controller and other sub remote controllers.
L20 Central controller L20	Duplicated indoor central addresses on communication of central control system (Detected by indoor/central controller side)	Stop (Automatic reset)	Displayed when trouble is detected	<ol style="list-style-type: none"> Check setting of central control system network address. (Network adapter SW01) Check network adapter P.C. board.
— *3 Central controller (Send) C05 (Receive) C06	Comm Communication circuit trouble of central (Detected by central controller side)	Continues (By remote controller)	Displayed when trouble is detected	<ol style="list-style-type: none"> Check communication wire / miswiring Check communication (U3, U4 terminals) Check network adapter P.C. board. Check central controller (such as central control remote controller, etc.) Check terminal resistance. (TCC-LINK)
— Central controller P30	Indoor Gr sub unit trouble (Detected by central controller side)	Continuation/Stop (According to each case)	Displayed when trouble is detected	Check the check code of the corresponding unit from remote controller.

*2 The check code cannot be displayed by the wired remote controller.
(Usual operation of air conditioner becomes unavailable.)
For the wireless models, a trouble is notified with indication lamp.

*3 This trouble is related to communication of remote controller (A, B), central system (TCC-LINK U3, U4), and [E01], [E02], [E03], [E09] or [E18] is displayed or no check display on the wired remote controller according to the contents.

7-2-4. Diagnostic Procedure for Each Check Code (Indoor Unit)

Check code

[E01 trouble]

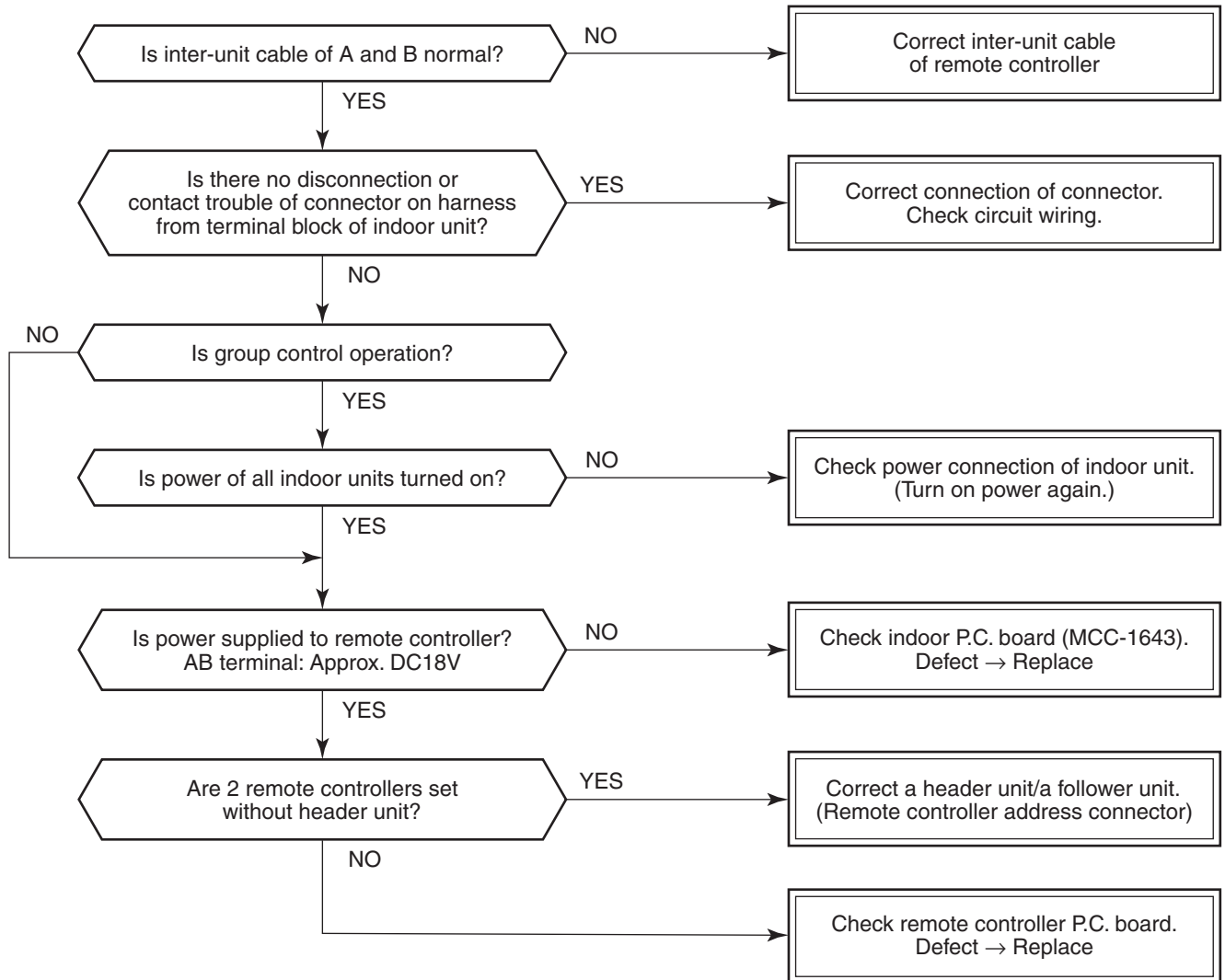

[E09 trouble]

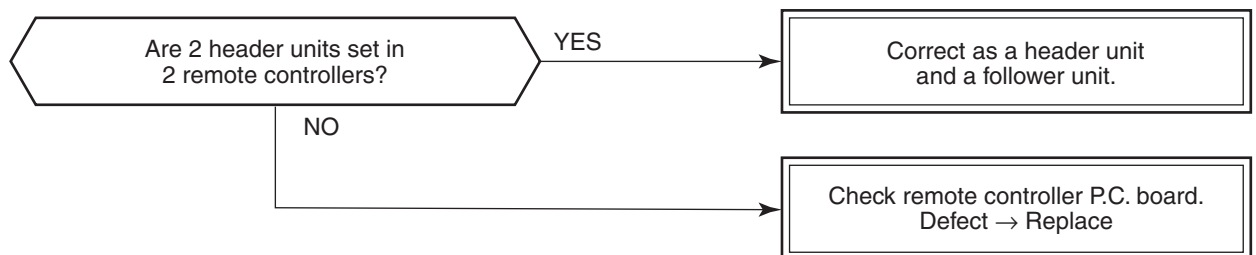

[E04 trouble]

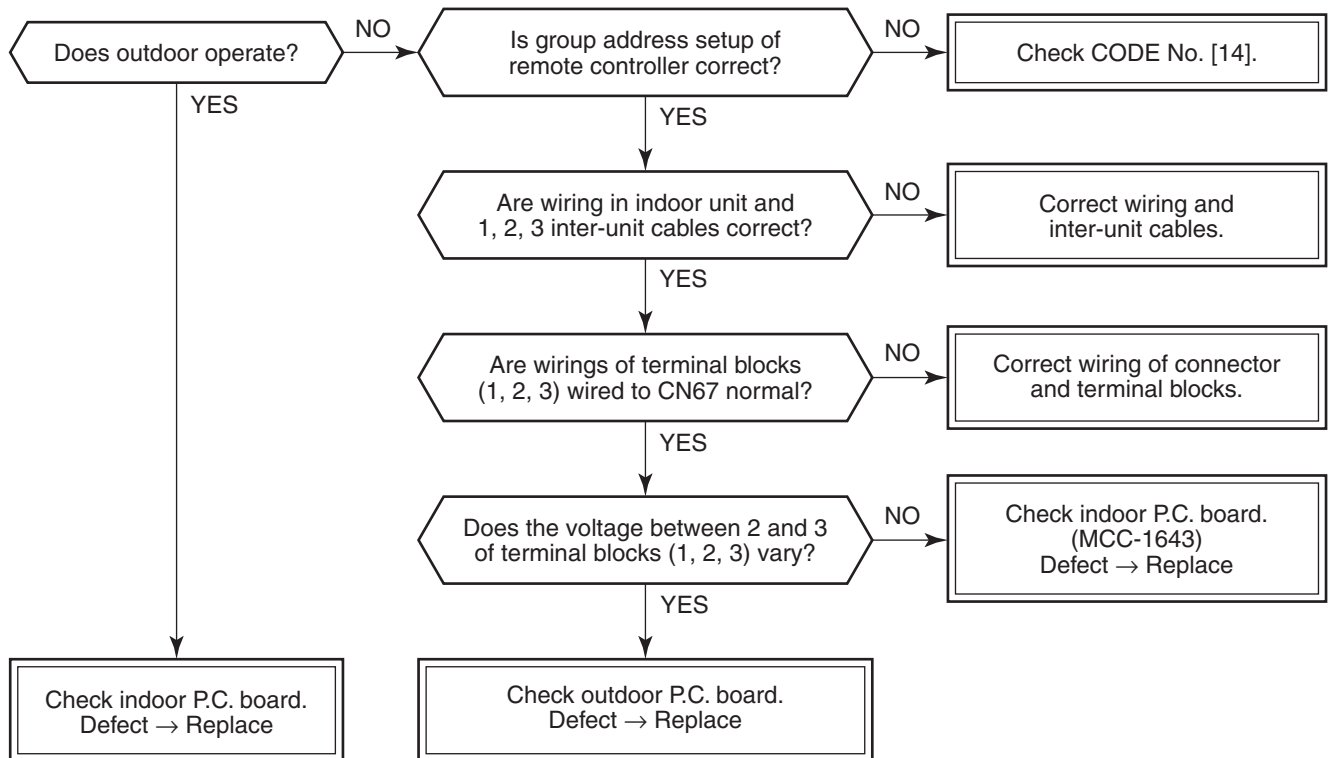

As shown in the following figure, carry out measurement within 20 seconds after the power was turned on.

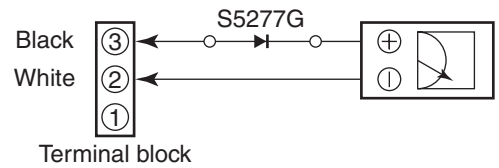

[E11 trouble]

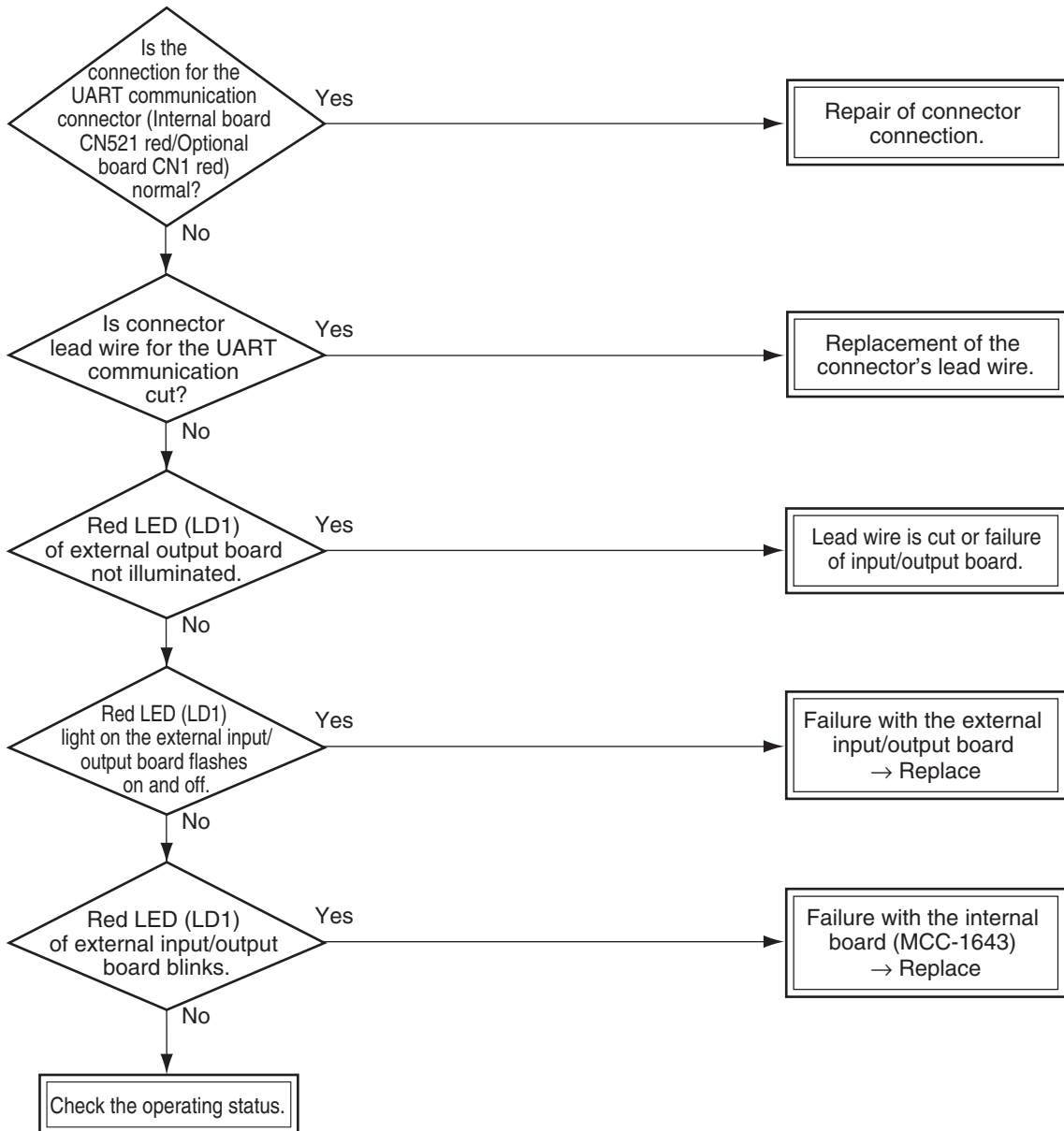

[E18 trouble]

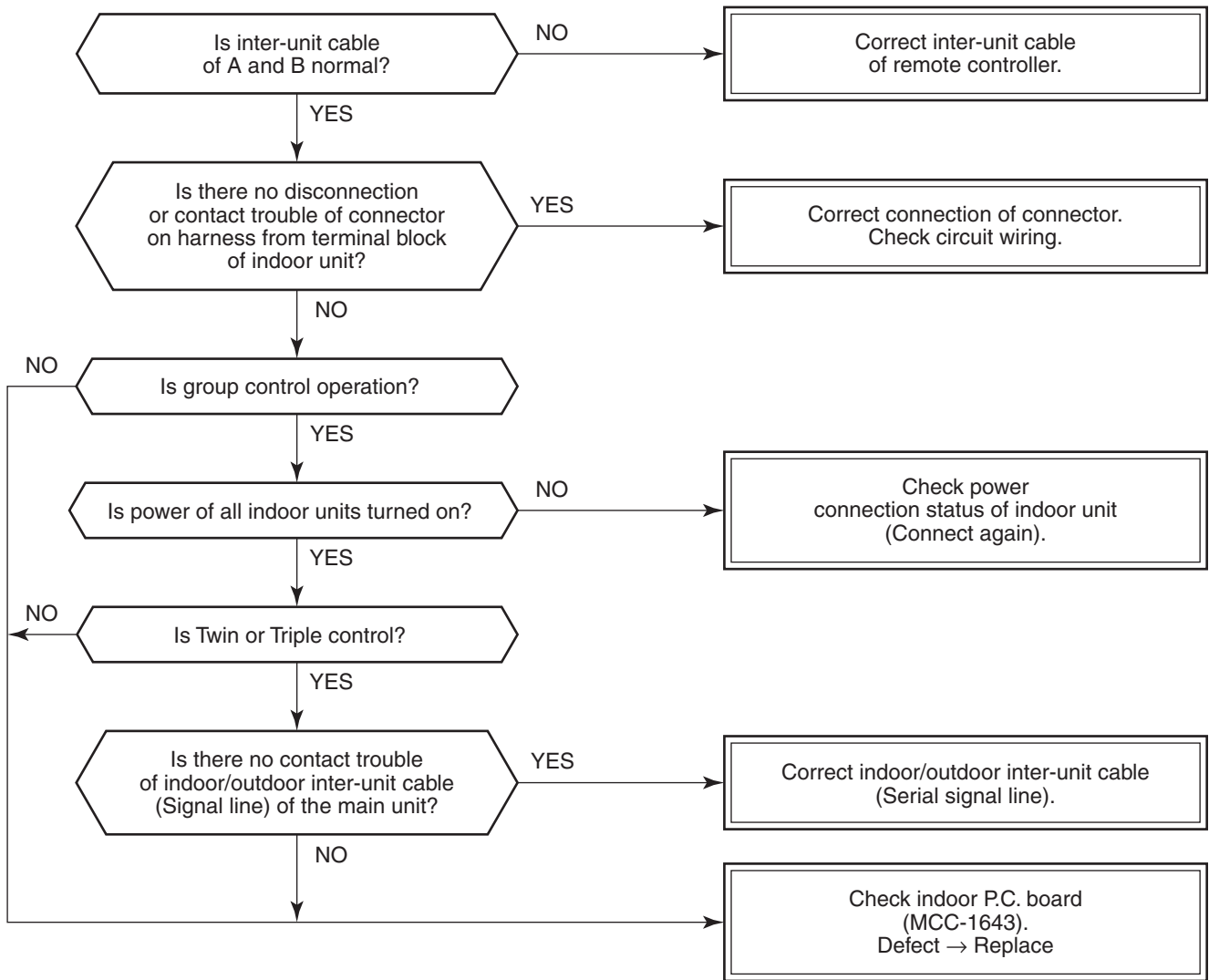

[E08, L03, L07, L08 trouble]

E08: Duplicated indoor unit No.

L03: There are 2 or more header units in a group control.

L07: There is 1 or more group address [Individual] in a group control.

L08: The indoor group address is unset. **(CODE No. 99)**

If the above trouble is detected when power supply turned on, the mode enters automatically in the automatic address set mode. (Check code is not output.)

However, if the above trouble is detected during the automatic address set mode, a check code may be output.

[L09 trouble]

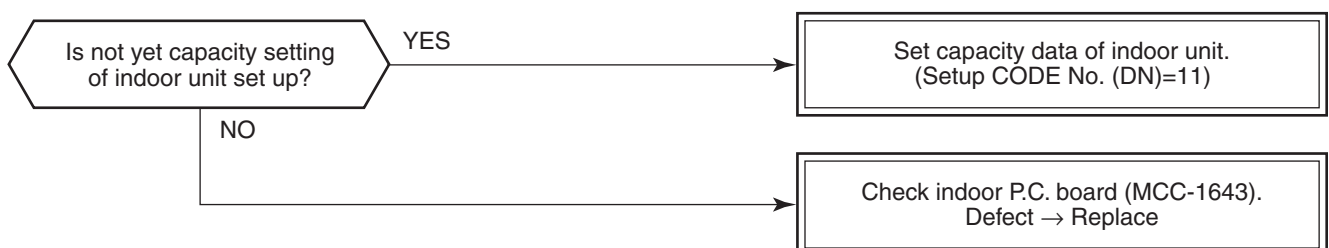

[L20 trouble]

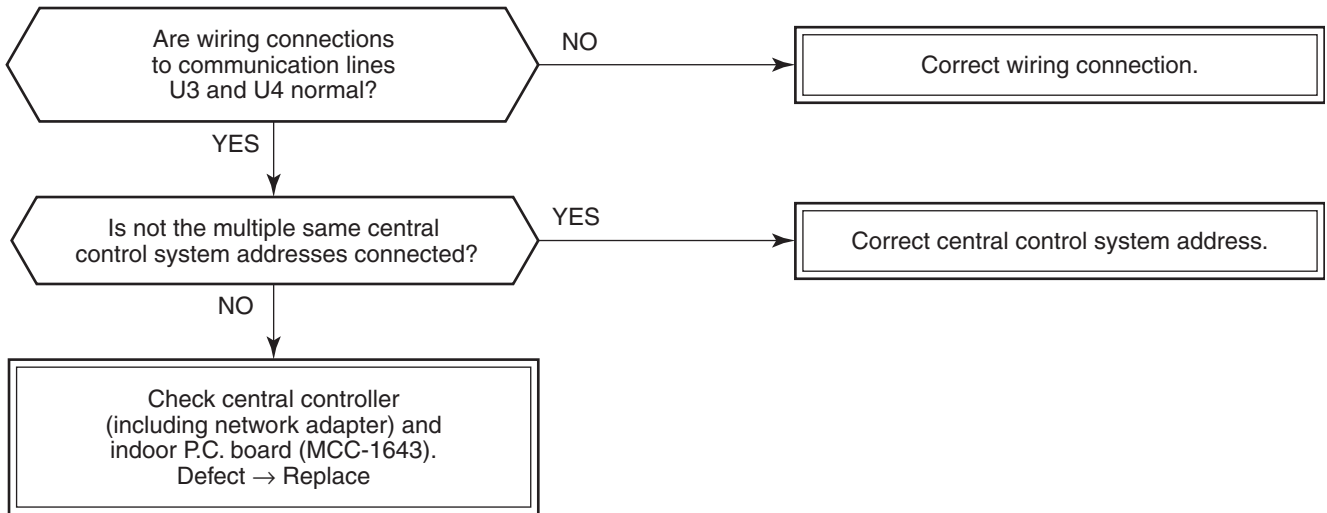

[L30 trouble]

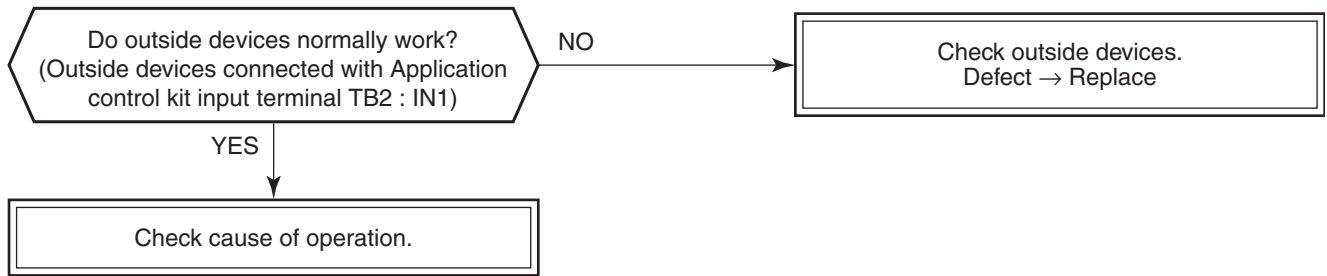

[P30 trouble] (Central controller)

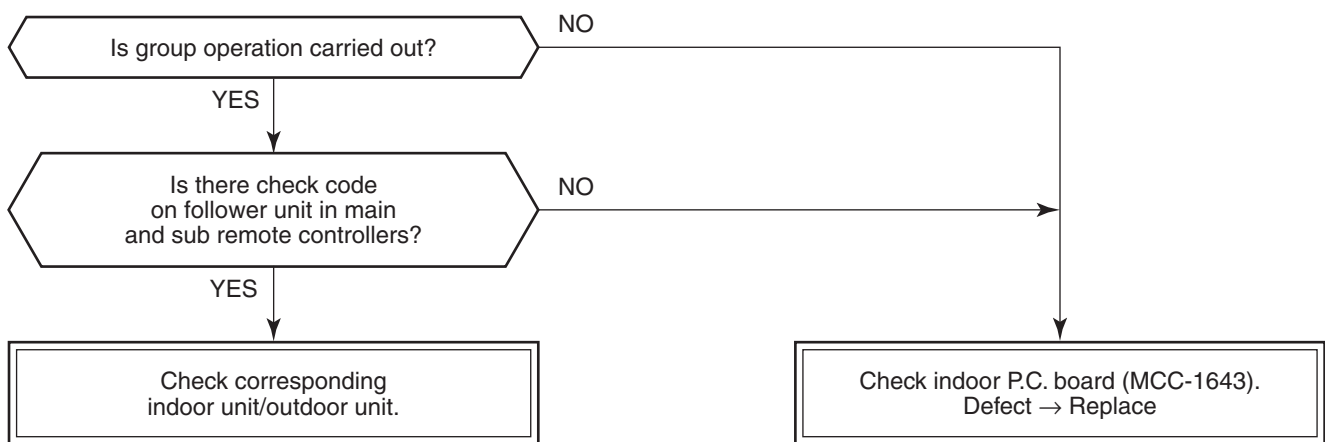

[P10 trouble]

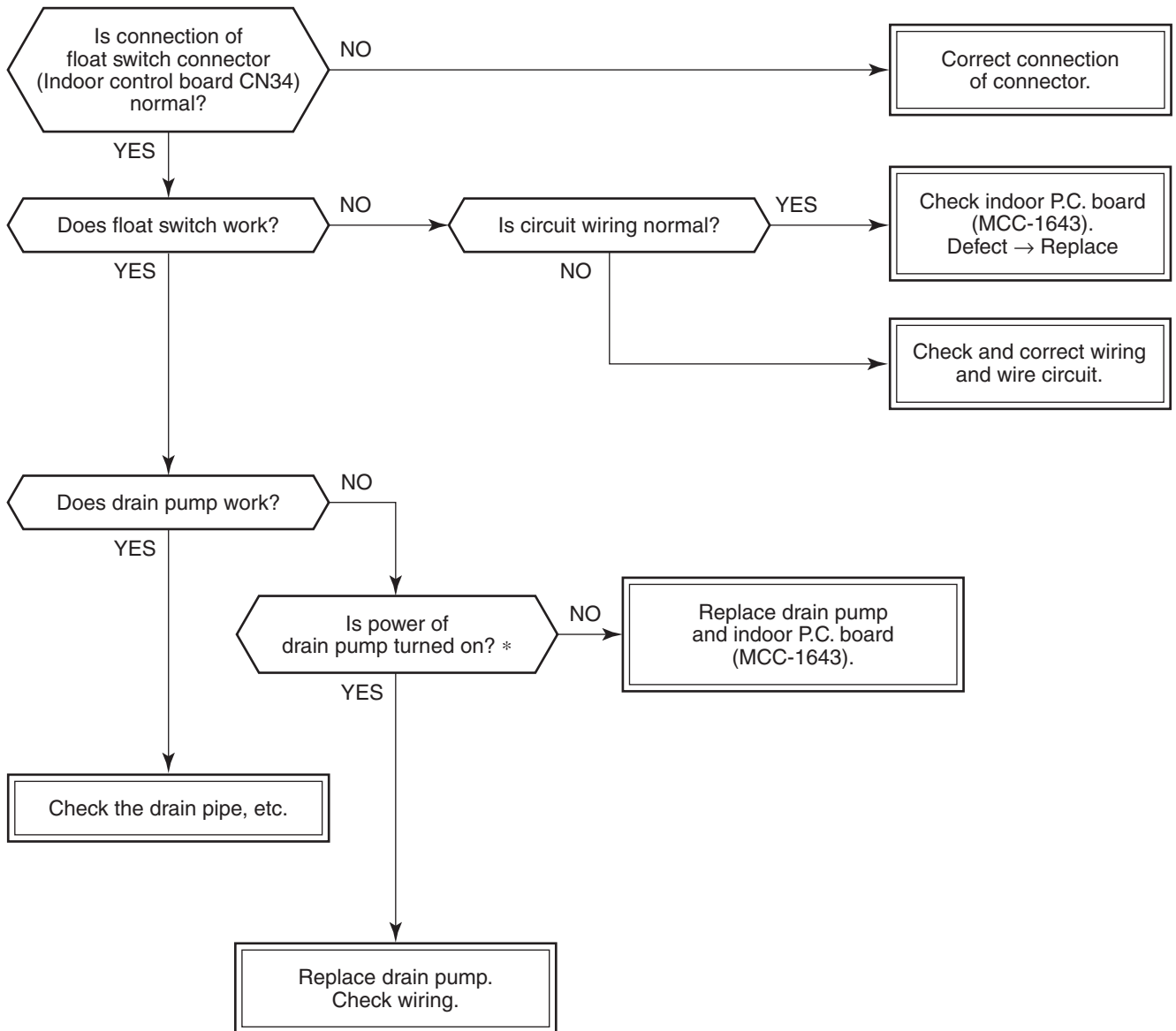

* Check that voltage of 1-2 pin of CN504 on the indoor P.C. board is +12V. (1 pin is plus (+).)

[F10 trouble]

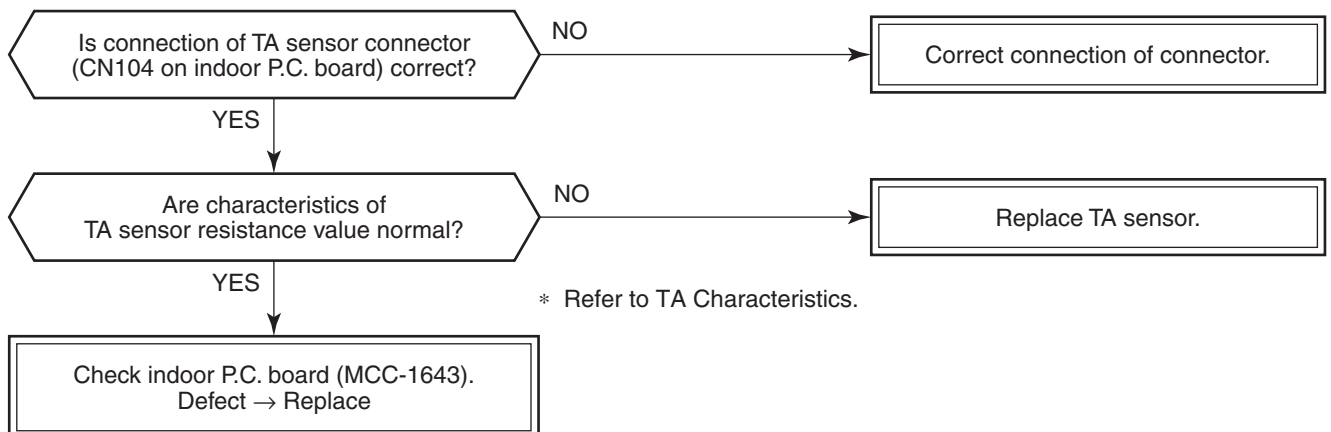

* Refer to TA Characteristics.

[P12 trouble]

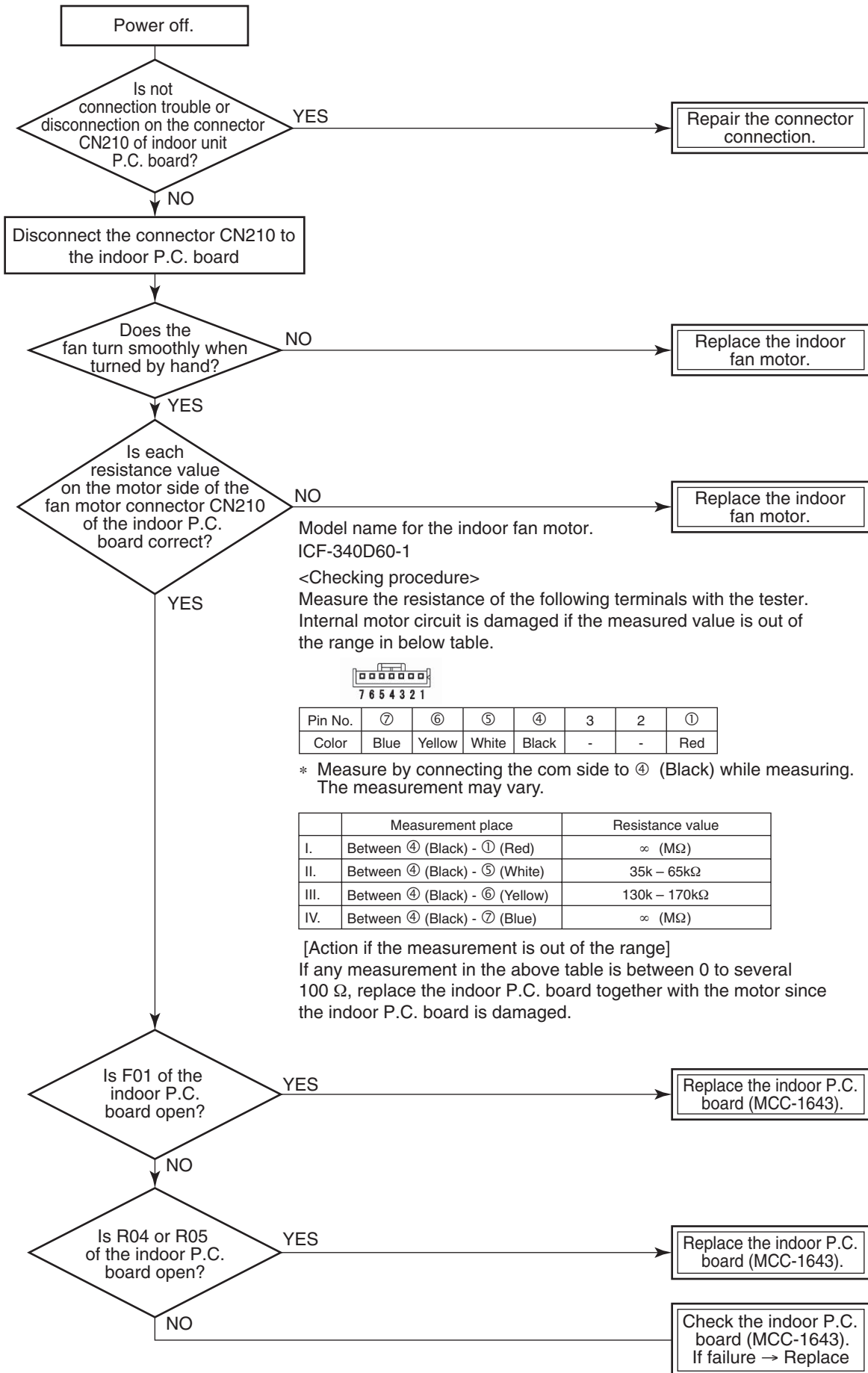

[P19 trouble]

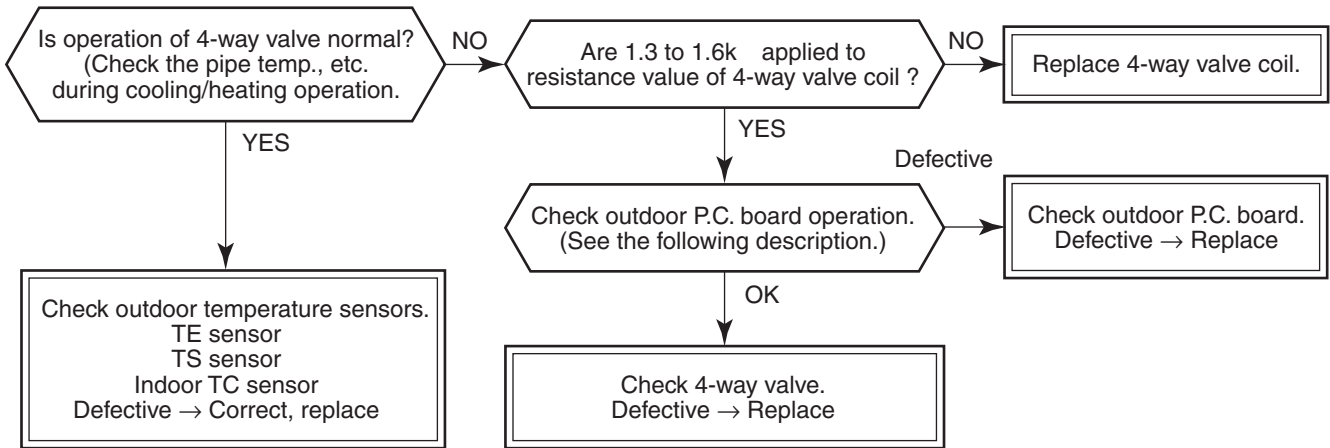

Operation check direction of the outdoor P.C. board (In case of self-preservation valve)

- 1) Set the Dip switch SW804 as same as the following table and push SW801 for approx. 1 second. It enables you to check the exchange operation to cooling cycle or heating cycle.
 - Only for approx. 10 seconds, the power is turned on.
 - As the heat value of part (coil: resistance R700) is large, when checking the operation continuously, wait 1 minute or more until the next check. (There is no problem if a coil is not connected.)
- 2) After check, turn off all the Dip switches SW804.

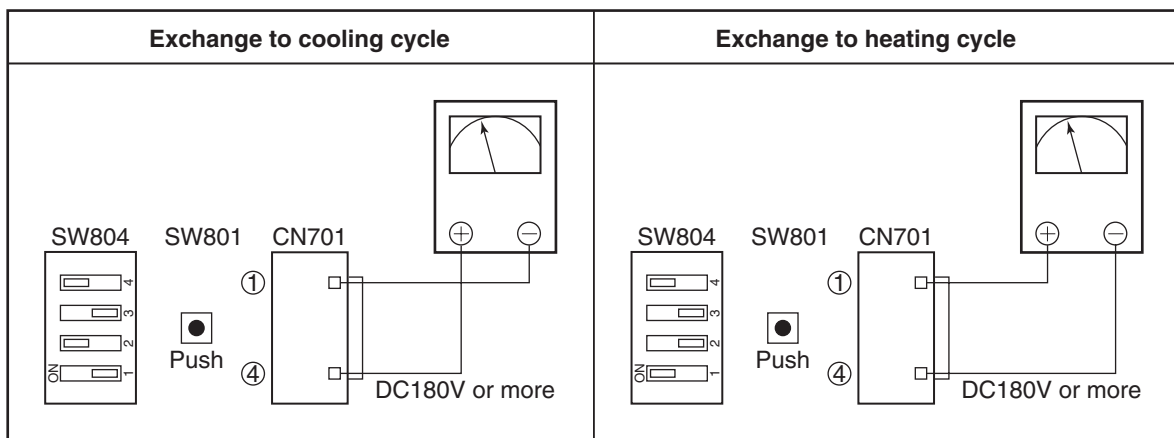

Check by tester

Analog tester: Good article if over DC180V

Digital tester: Although in some cases, the value varied and indicated. If the maximum value is DC180V or more, it is good article.

[F02 trouble]

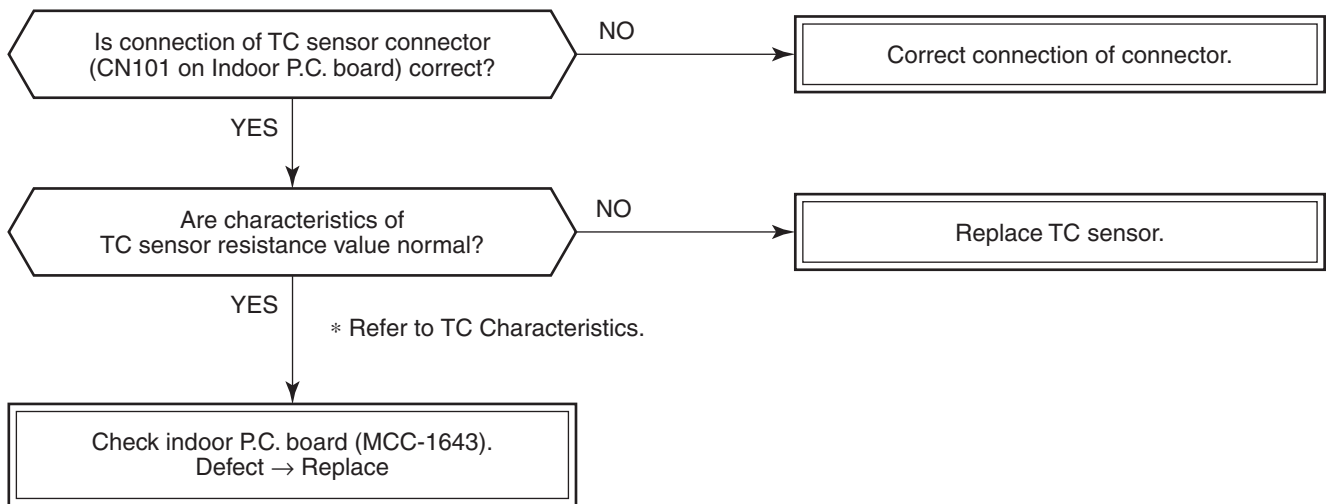

[F01 trouble]

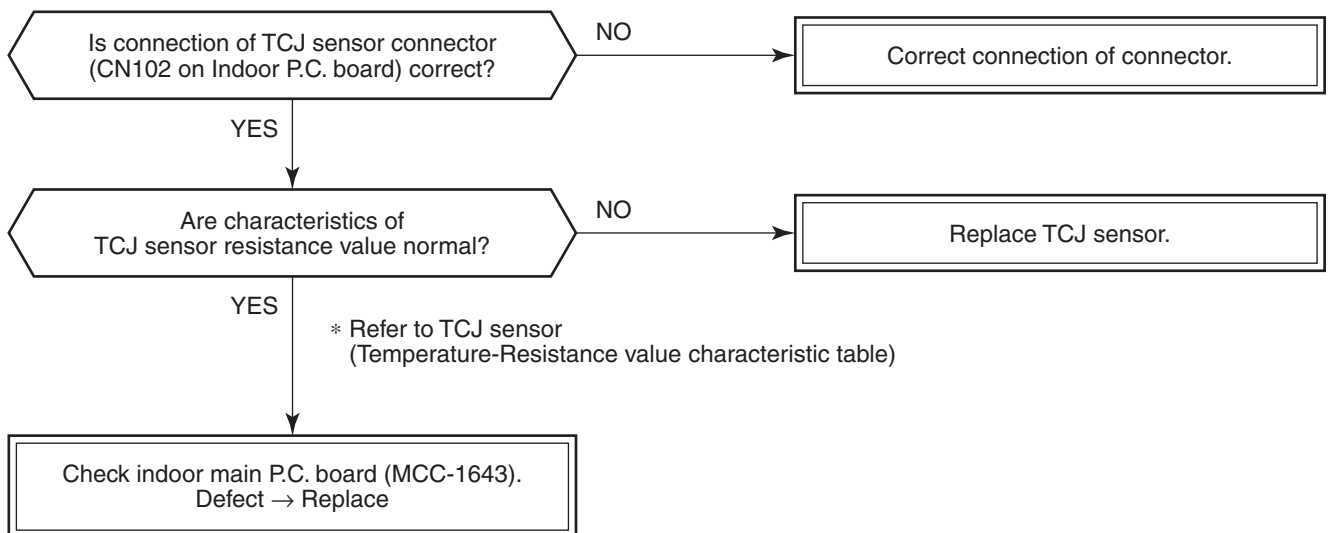

[F30 trouble]

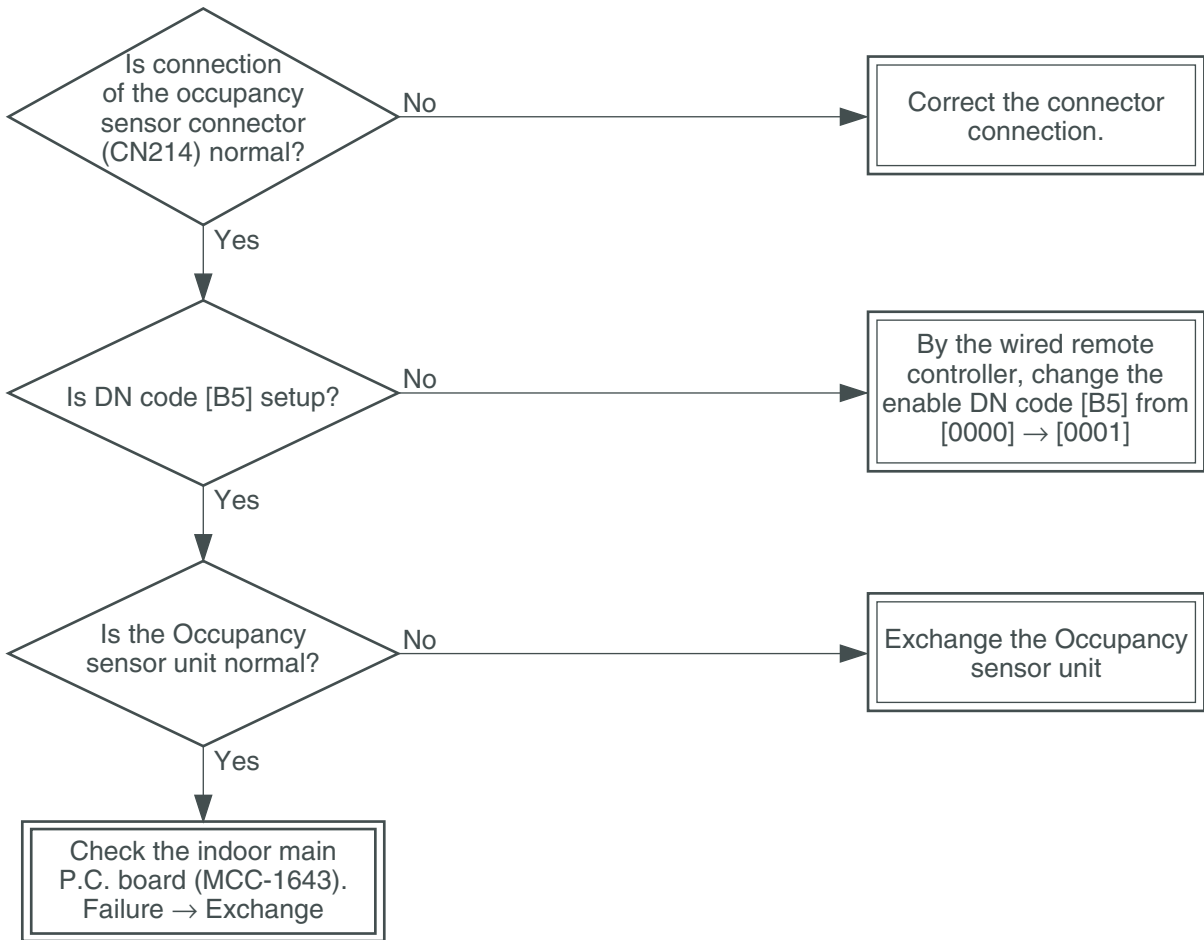

[C06 trouble] (“1:1 model” connection interface)

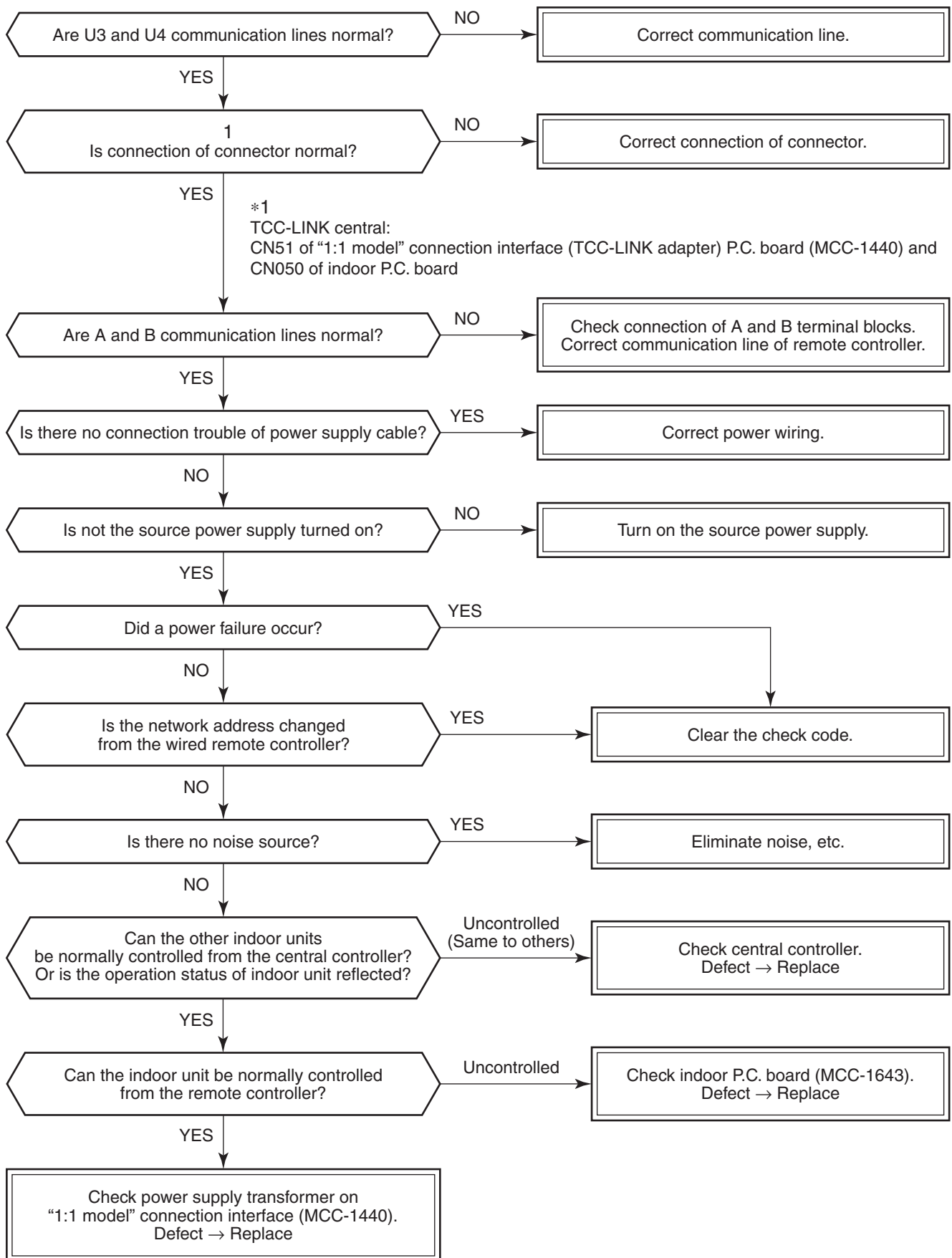

[E03 trouble] (Header indoor unit)

[E03 trouble] is detected when the indoor unit cannot receive a signal from the remote controller (also central controller).

Check A and B remote controllers and communication lines of the central control system U3 and U4.

As communication is impossible, this check code [E03] is not displayed on the remote controller and the central controller. [E01] is displayed on the remote controller and [C06 trouble] is displayed on the central controller.

If these check codes generate during operation, the air conditioner stops.

[F29 trouble]

This check code indicates a detection trouble of IC503 non-volatile memory (EEPROM) on the indoor unit P.C. board, which generated during operation of the air conditioner. Replace the service P.C. board.

* When EEPROM was not inserted when power supply turned on or when the EEPROM data read/write operation is impossible at all, the automatic address mode is repeated. In this time, [C06 trouble] is displayed on the central controller.

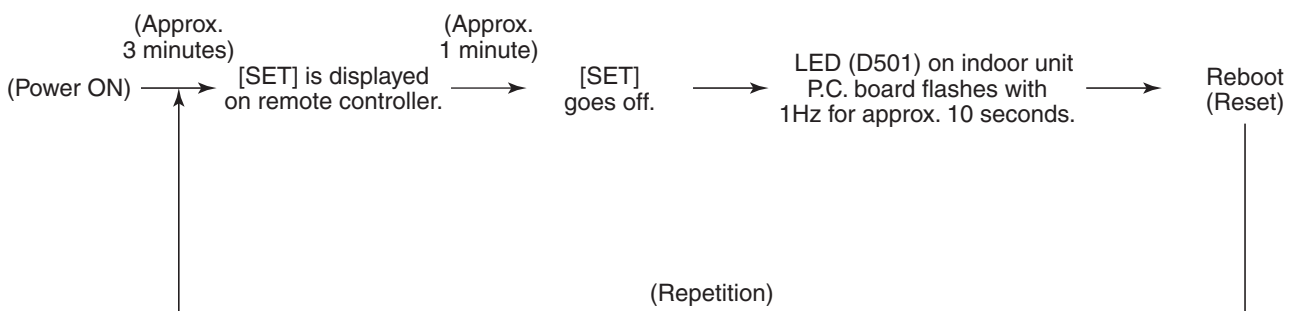

[P31 trouble] (Follower indoor unit)

When the header unit of a group operation detected [E03], [L03], [L07] or [L08] trouble, the follower unit of the group operation detects [P31 trouble] and then the unit stops.

There is no display of the check code or alarm history of the wired remote controller. (In this model, the mode enters in automatic address set mode when the header unit detected [L03], [L07] or [L08] trouble.)

[Wireless remote controller trouble]

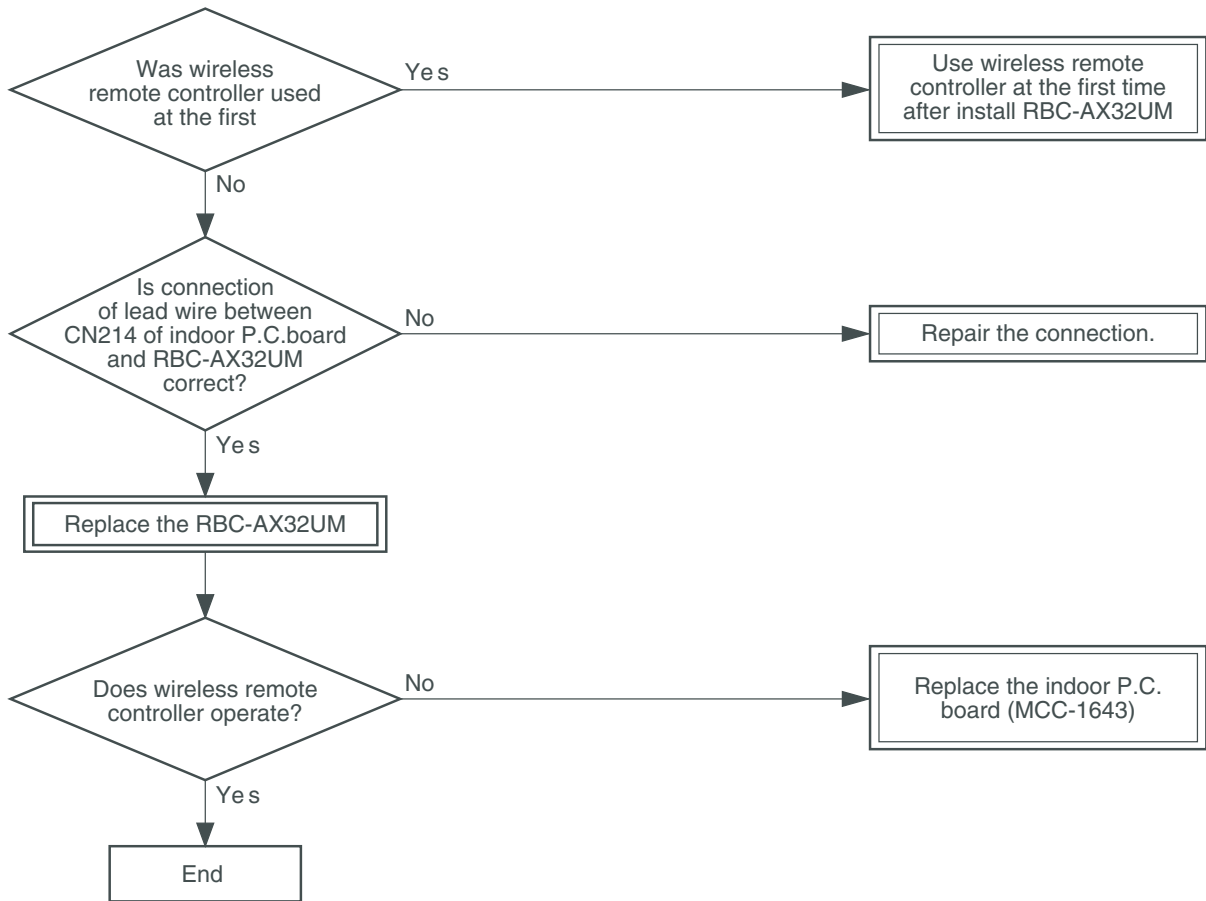

Temperature sensor

Temperature – Resistance value characteristic table

TA, TC, TCJ, TE, TS, TO sensors

TD, TL sensors

Representative value

Representative value

Temperature (°C)	Resistance value (kΩ)		
	(Minimum value)	(Standard value)	(Maximum value)
0	32.33	33.80	35.30
10	19.63	20.35	21.09
20	12.23	12.59	12.95
25	9.75	10.00	10.25
30	7.764	7.990	8.218
40	5.013	5.192	5.375
50	3.312	3.451	3.594
60	2.236	2.343	2.454
70	1.540	1.623	1.709
80	1.082	1.146	1.213
90	0.7740	0.8237	0.8761
100	0.5634	0.6023	0.6434

Temperature (°C)	Resistance value (kΩ)		
	(Minimum value)	(Standard value)	(Maximum value)
0	150.5	161.3	172.7
10	92.76	99.05	105.6
20	58.61	62.36	66.26
25	47.01	49.93	52.97
30	37.93	40.22	42.59
40	25.12	26.55	28.03
50	17.00	17.92	18.86
60	11.74	12.34	12.95
70	8.269	8.668	9.074
80	5.925	6.195	6.470
90	4.321	4.507	4.696
100	3.205	3.336	3.468

TA, TC, TCJ, TE, TS, TO sensors

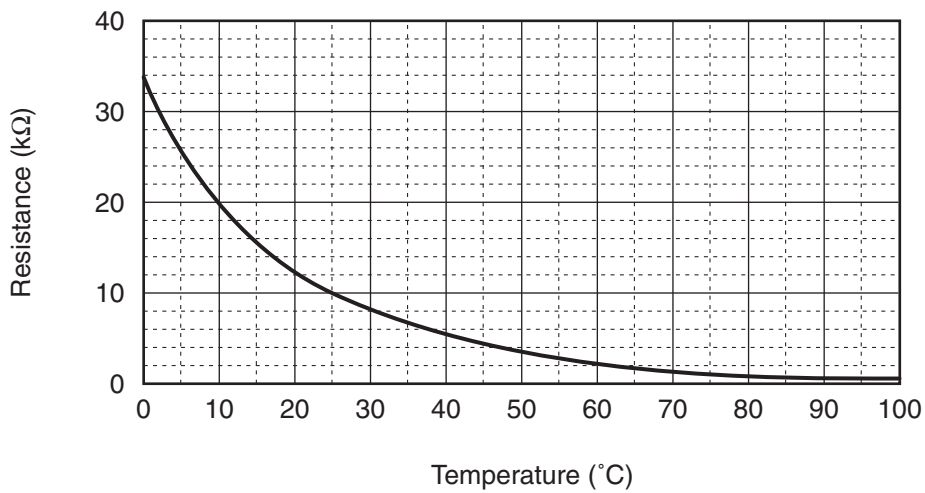

TD, TL sensors

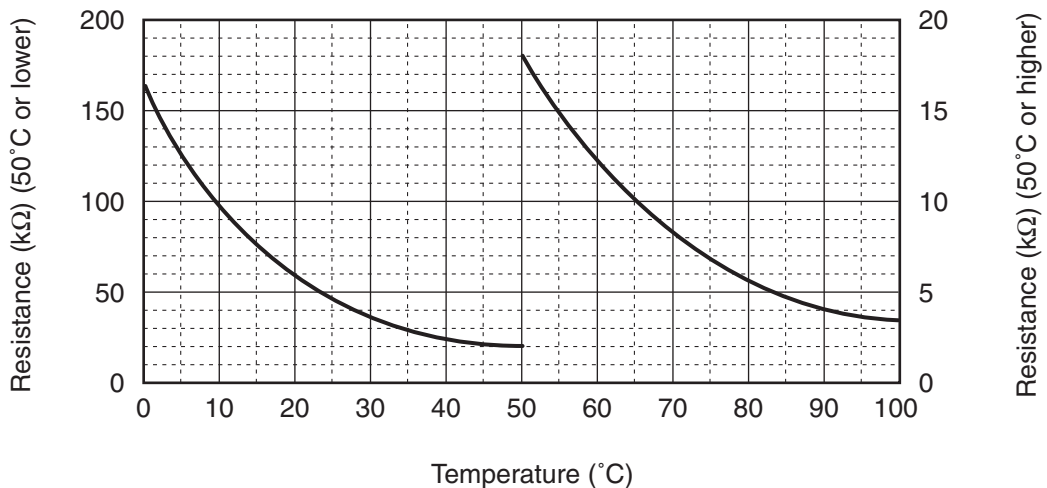

* As TH sensor (Outdoor unit heat sink temp. sensor) is incorporated in the outdoor control P.C. board, the resistance value cannot be measured.

8. REPLACEMENT OF SERVICE P.C. BOARD

8-1. Indoor Unit

CAUTION

<Model name: RAV-RM***MUT*>

For the above models, set the CODE No. “E ” and the setting data “0000” (initial) to “0001”.

<Note: when replacing the P.C. board for indoor unit servicing>

The nonvolatile memory (hereafter called EEPROM, IC503) on the indoor unit P.C. board before replacement includes the model specific type information and capacity codes as the factory-set value and the important setting data which have been automatically or manually set when the indoor unit is installed, such as system/indoor/group addresses, high ceiling select setting, etc.

When replacing the P.C. board for indoor unit servicing, follow the procedures below.

After replacement completes, confirm whether the settings are correct by checking the indoor unit No., Group header unit/follower unit settings and perform the cooling cycle confirmation through the trial operation.

<Replacement procedures>

CASE 1

Before replacement, the indoor unit can be turned on and the setting data can be read out by wired remote control operation.

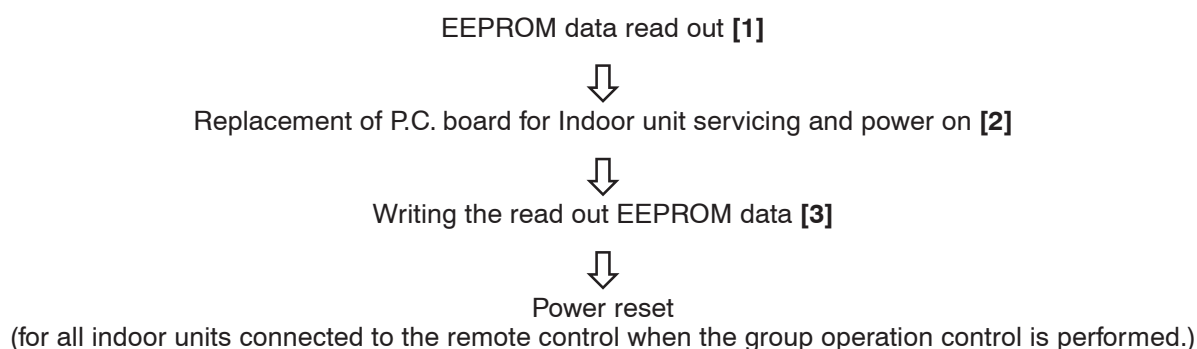

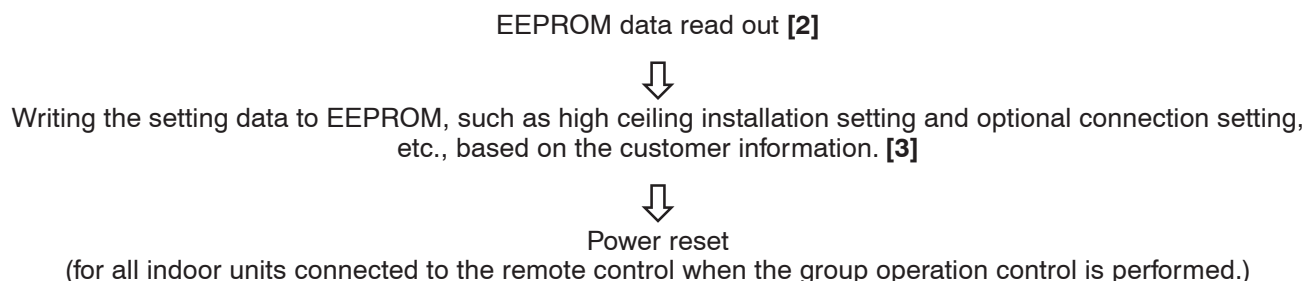

CASE 2

The EEPROM before replacement is defective and the setting data cannot be read out.





[1] Setting data read out from EEPROM

The setting data modified on the site, other than factory-set value, stored in the EEPROM shall be read out.

Step 1 Push ,  and  button on the remote controller simultaneously for more than 4 seconds.

* When the group operation control is performed, the unit No. displayed for the first time is the header unit No.

At this time, the CODE No. (DN) shows “  ”. Also, the fan of the indoor unit selected starts its operation and the swing operation also starts if it has the louvers.

Step 2 Every time when the  (left side button) button is pushed, the indoor unit No. under the group control is displayed in order. Specify the indoor unit No. to be replaced.

1. Change the CODE No. (DN) to  →  by pushing  /  buttons for the temperature setting. (this is the setting for the filter sign lighting time.)

At this time, be sure to write down the setting data displayed.

2. Change the CODE No. (DN) by pushing  /  buttons for the temperature setting. Similarly, be sure to write down the setting data displayed.

3. Repeat the step 2-2 to set the other settings in the same way and write down the setting data as shown in the table 1 (example).

* The CODE No. (DN) are ranged from “  ” to “ FF ”. The CODE No. (DN) may skip.

Step 3 After writing down all setting data, push  button to return to the normal stop status. (It takes approx. 1 min until the remote controller operation is available again.)

CODE No. required at least

DN	Contents
10	Type
11	Indoor unit capacity
12	System address
13	Indoor unit address
14	Group address

1. The CODE No. for the Indoor unit type and Indoor unit capacity are required to set the rotation number setting of the fan.
2. If the system/indoor/group addresses are different from those before replacement, the auto-address setting mode starts and the manual resetting may be required again. (when the multiple units group operation including twin system.)

[2] P.C. Board for indoor unit servicing replacement procedures

Step 1 Replace the P.C. board to the P.C. board for indoor unit servicing.



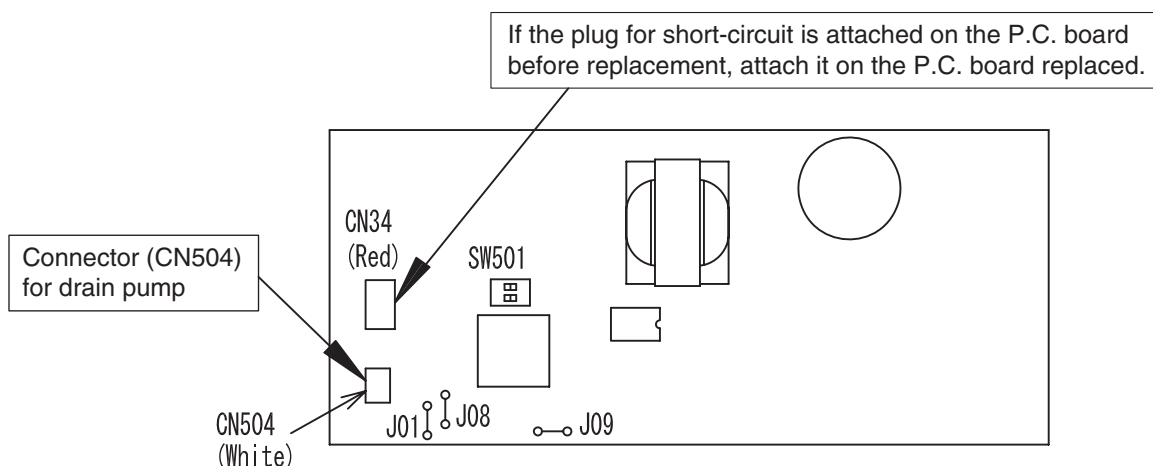

At this time, perform the same setting of the jumper wire (J01, J08, J09) setting (cut), switch SW501, (short-circuit) connector CN34 as the setting of the P.C. board before replacement.



Step 2 According to the system configuration, turn on the indoor unit following to the either methods shown below.

a) Single operation (Indoor unit is used as standalone.)

Turn on the indoor unit.

1. After completion of the auto-address setting mode (required time: approx. 5 min.), proceed to [3]. (System address = 1, Indoor unit address = 1, Group address = 0 (standalone) are automatically set.)
2. Push ,  and  buttons simultaneously for more than 4 seconds to interrupt the auto-address setting mode, and proceed to [3]. (The unit No. “  ” is displayed.)

b) Group operation (including twin triple and double twin system)

Turn on the indoor unit(s) with its P.C. board replaced to the P.C. board for indoor unit servicing, according to either methods 1 or 2 shown below.

1. Turn on only the indoor unit with its P.C. board replaced. (Be sure to confirm the remote controller is surely connected. If not, the operation [3] cannot be performed.)
Perform either methods 1 or 2 described in item a) above.
2. Turn on the multiple indoor units including the indoor unit with its P.C. board replaced.
 - Twin or triple or double twin 1 system only
 - All group connections

After completion of the auto-address setting mode (required time: approx. 5 min.), proceed to [3].

* The header unit of the group may be changed by performing the auto-address setting.

Also, the system address/Indoor unit address of the indoor unit with its P.C. board replaced may be assigned to the addresses (not used) other than those of the indoor units without its P.C. board replaced.

It is recommended to keep the information in advance, which cooling system the indoor unit belongs to or whether the indoor unit works as the header unit or the follower unit in the group control operation.

[3] Writing the setting data to EEPROM

The settings stored in the EEPROM of the P.C. board for indoor unit servicing are the factory-set values.

Step 1 Push , and buttons on the remote controller simultaneously for more than 4 seconds.

* In the group control operation, the unit No. displayed for the first time is the header unit No..

At this time, the CODE No. (DN) shows "10". Also, the fan of the indoor unit selected starts its operation and the swing operation starts if it has the louvers.

(The unit No. "RL" is displayed if the auto-address setting mode is interrupted in [2] step 2 a))

Step 2 Every time when (left side button) button is pushed, the indoor unit No. in the group control operation are displayed in order.

(The settings stored in the EEPROM of the P.C. board for indoor unit servicing are the factory-set values.)

Specify the indoor unit No. with its P.C. board replaced to the P.C. board for indoor unit servicing. (You cannot perform this operation if "RL" is displayed.)

Step 3 Select the CODE No. (DN) can be selected by pushing the / button for the temperature setting.

• Set the indoor unit type and capacity.

The factory-set values shall be written to the EEPROM by changing the type and capacity.

1. Set the CODE No. (DN) to "10". (without change)
2. Select the type by pushing / buttons for the timer setting. (For example, Compact 4-way Cassette Type is set to "00 14". Refer to table 2)
3. Push button. (The operation completes if the setting data is displayed.)
4. Change the CODE No. (DN) to "11" by pushing / buttons for the temperature setting.
5. Select the capacity by pushing / buttons for the timer setting. (For example, 56 Type is set to "0009". Refer to table 3)
6. Push button. (The setting completes if the setting data are displayed.)
7. Using the set temperature / buttons, set "1E" to the CODE No. (DN).
8. Using the timer time / buttons, set the dat. (0001)
9. Push button (The setting completes if the setting data are displayed.)
10. Push the button to return to the normal stop status (It takes approx. 1 min until the remote control operation is available again.)

<Fig. 1 RBC-AMT32E>

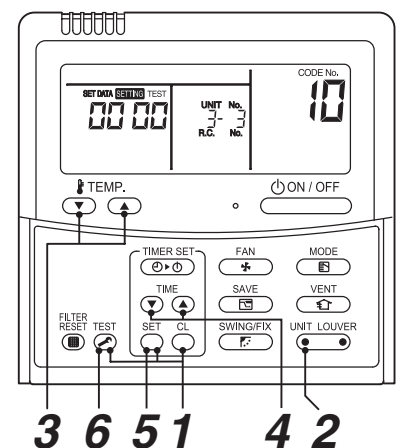

- Step 4** Write the on-site setting data to the EEPROM, such as address setting, etc. Perform the steps 1 and 2 above again.
- Step 5** Change the CODE No. (DN) to “01” by pushing ▼ / ▲ buttons for the temperature setting. (this is the setting for the filter sign lighting time.)
- Step 6** Check the setting data displayed at this time with the setting data put down in [1].
1. If the setting data is different, modify the setting data by pushing ▼ / ▲ buttons for the timer setting to the data put down in [1].
The operation completes if the setting data is displayed.
 2. If the data is the same, proceed to next step.
- Step 7** Change the CODE No. (DN) by pushing ▼ / ▲ buttons for the temperature setting. As described above, check the setting data and modify to the data put down in [1].
- Step 8** Repeat the steps 6 and 7.
- Step 9** After the setting completes, push ^{TEST} button to return to the normal stop status. (It takes approx. 1 min until the remote control operation is available again.)
- * The CODE No. (DN) are ranged from “01” to “FF”. The CODE No. (DN) is not limited to be serial No.. Even after modifying the data wrongly and pushing ^{SET} button, it is possible to return to the data before modification by pushing ^{SET} button if the CODE No. (DN) is not changed.

<Fig. 2 EEPROM layout diagram>

The EEPROM (IC503) is attached to the IC socket. When detaching the EEPROM, use a tweezers, etc. Be sure to attach the EEPROM by fitting its direction as shown in the figure.

* Do not bend the IC lead when replacing.

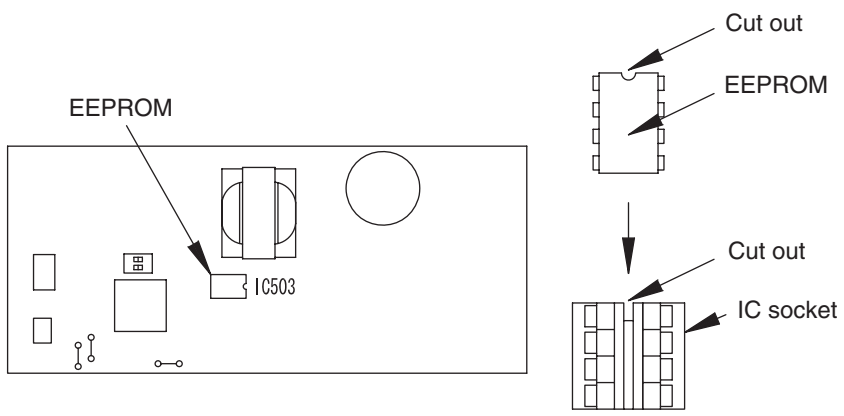

Table 1. Setting data (CODE No. table (example))

CODE No. (DN)	Item	Setting data	Factory-set value
01	Filter sign lighting time		Depending on Type
02	Filter pollution level		0000: standard
03	Central control address		0099: Not determined
06	Heating suction temperature shift		0002: +2 °C
0F	Cooling only		0000: Heat pump
10	Type		Depending on model type
11	Indoor unit capacity		Depending on capacity type
12	System address		0099: Not determined
13	Indoor unit address		0099: Not determined
14	Group address		0099: Not determined
19	Louver type (wind direction adjustment)		Depending on Type.
1E	Temperature range of cooling/heating automatic SW control point		0003: 3 deg (Ts ±1.5)
28	Power failure automatic recovery		0000: None
2b	Thermo output SW (T10 ③)		0000: Thermo ON
31	Ventilation fan (standalone)		0000: Not available
32	Sensor SW (Selection of static pressure)		0000: Body sensor
5d	High ceiling SW		0000: Standard
60	Timer setting (wired remote controller)		0000: Available
77	Dual set point		0000: Unavailable
8b	Correction of high heat feeling		0000: None
b3	Soft cooling		0001: Available
b5	Occupancy sensor: Provided/None		0000: None
b6	Occupancy sensor: Enable/Invalid (Judgment time of absence)		0002: Enable (60 min.)
b7	Occupancy sensor: Operation at absent time		0000: Stand by
C2	Demand setting (outdoor unit current demand)		0075: 75 %
d0	Remote controller operation save function		0001: Enable
d1	Frost protection function		0000: None
F0	Swing mode		0001: Standard
F1	Louver fixing position (Flap No. 1)		0000: Not fixed
F2	Louver fixing position (Flap No. 2)		0000: Not fixed
F3	Louver fixing position (Flap No. 3)		0000: Not fixed
F4	Louver fixing position (Flap No. 4)		0000: Not fixed
F6	Presence of Application control kit		0000: None

Table 2. Type: CODE No. 10

Setting data	Type	Type name abb.
0001*1	4-way Cassette Type	RAV-GM***UT*
0014*2	Compact 4-way Cassette Type	RAV-RM***MUT*

*1 EEPROM initial value on the P.C. board for indoor unit servicing.

*2 ⚠ CAUTION

<Model name: RAV-RM***MUT*>

For above models, set the CODE No. to “**1E**” and the setting data “**0000**” (initial) to “**0001**”.

Table 3. Indoor unit capacity: CODE No. 11

Setting data	Type
0000*	Disable
0003	30
0006	40
0009	56



* EEPROM initial value on the P.C. board for indoor unit servicing.

9. SETUP AT LOCAL SITE AND OTHERS

9-1. Indoor Unit

9-1-1. Test Run Setup on Remote Controller



<Wired remote controller>

- When pushing  button on the remote controller for 4 seconds or more, "TEST" is displayed on LC display. Then push  button.
 - "TEST" is displayed on LC display during operation of Test Run.
 - During Test Run, temperature cannot be adjusted but air volume can be selected.
 - In heating and cooling operation, a command to fix the Test Run frequency is output.
 - Detection of trouble is performed as usual. However, do not use this function except case of Test Run because it applies load on the unit.
- Use either heating or cooling operation mode for [TEST].

NOTE : The outdoor unit does not operate after power has been turned on or for approx. 3 minutes after operation has stopped.
- After a Test Run has finished, push  button again and check that [TEST] on LC display has gone off. (To prevent a continuous test run operation, 60-minutes timer release function is provided to this remote controller.)

<Wireless remote controller>

◆ In case of wireless remote controller

- Turn on the power of the air conditioner.
When power is turned on for the first time after installation, it takes approx. 5 minutes until the remote controller becomes available. In the case of subsequent power-on, it takes approx. 1 minute until the remote controller becomes available.
Execute a test run after the predetermined time has passed.
- Push "ON/OFF" button on the remote controller, select [ Cool] or [ Heat] with "MODE" button, and then select [ HIGH] with "FAN" button.

3

Cooling test run	Heating test run
Set the temperature to 17 °C with the temp. setup buttons.	Set the temperature to 30 °C with the temp. setup buttons.

4

Cooling test run	Heating test run
After confirming a signal receiving sound "beep" immediately set the temperature to 18 °C with the temp. setup buttons.	After confirming a signal receiving sound "beep" immediately set the temperature to 29 °C with the temp. setup buttons.

5

Cooling test run	Heating test run
After confirming a signal receiving sound "beep" immediately set the temperature to 17 °C with the temp. setup buttons.	After confirming a signal receiving sound "beep" immediately set the temperature to 30 °C with the temp. setup buttons.

6 Repeat procedures **4 → 5 → 4 → 5**.
Indicators “Operation” (green), “Timer” (green), and “Ready” (orange) in the wireless receiver section flash in approx. 10 seconds, and the air conditioner starts operation. If any of these indicators does not flash, repeat procedures 2 to 5.

7 Upon completion of the test run, push “ON/OFF” button to stop operation.

<Overview of test run operations using the wireless remote controller>

▼ **Cooling test run:**

ON/OFF → 18 °C → 17 °C → 18 °C → 17 °C → 18 °C → 17 °C → 18 °C → (test run) → ON/OFF

▼ **Heating test run:**

ON/OFF → 29 °C → 30 °C → 29 °C → 30 °C → 29 °C → 30 °C → 29 °C → (test run) → ON/OFF

9-1-2. Forced Defrost Setup of Remote Controller (For wired remote controller only)

(Preparation in advance)

1 Push  +  +  buttons simultaneously for 4 seconds or more on the remote controller. (Push buttons while the air conditioner stops.)

The first displayed unit No. is the header indoor unit address in the group control.

2 Every pushing  button (button of the left side), the indoor unit No. in the group control is displayed one after the other.

Select a main indoor unit (outdoor unit is connected) which is to be defrosted. In this time, fan and louver of the selected indoor unit operate.

3 Using the set temperature   buttons, specify the CODE No. (DN) **BC**.

4 Using the timer time   buttons, set time to data **000** l. (**0000** at shipment)

5 Push  button. (OK if indication lights)

6 Pushing  button returns the status to the normal stop status.

(Practical operation)

- Push ON/OFF  button.
- Select the HEAT mode.
- After a while, the forced defrost signal is sent to the outdoor unit and then the outdoor unit starts defrost operation. (The forced defrost operation is performed for Max. 12 minutes.)
- After defrost operation finished, the operation returns to the heating operation.

To execute the defrost operation again, start procedure from above item **1**.

(If the forced defrost operation was executed once, setting of the above forced defrost operation is cleared.)

9-1-3. LED Display on P.C. Board

1. D501 (Red)

- It goes on (Goes on by operation of the main microcomputer) at the same time when the power supply is turned on.
- It flashes with 1-second interval (every 0.5 second): When there is no EEPROM or writing-in operation fails.
- It flashes with 10-seconds interval (every 5 second): During DISP mode
- It flashes with 2-seconds interval (every 1 second): While setting of function select (EEPROM)

2. D403 (Red)

- It goes on when power supply of the remote controller is turned on. (Lights on hardware)

3. D503 (Yellow): Main bus communication

- It goes on for 5 seconds in the first half of communication with the central controller.

4. D504 (Green): Sub bus communication

- It flashes for 5 seconds in the first half of communication with the remote controller. (Group header unit)
- It flashes with 0.2-second interval (for 0.1 second) for 5 second in the latter half of communication between header and follower in the Gr indoor unit.

5. D14 (Orange)

- It flashes while receiving the serial signal from the outdoor unit. (Hardware)

6. D15 (Green)

- It flashes while sending the serial signal to the outdoor unit. (Hardware)

9-1-4. Function Selection Setup

<Procedure> Perform setting while the air conditioner stops.

1 Push **TEST** + **SET** + **CL** buttons simultaneously for 4 seconds or more.

The first displayed unit No. is the header indoor unit address in the group control.
In this time, fan and louver of the selected indoor unit operate.



2 Every pushing **UNIT LOUVER** button (button at left side), the indoor unit No. in the group control is displayed one after the other. In this time, fan and louver of the selected indoor unit only operate.



3 Using the set temperature **TEMP.** buttons, specify the CODE No. (DN).



4 Using the timer time **TIME** buttons, select the set data.



5 Push **SET** button. (OK if indication lights)

- To change the selected indoor unit, proceed to Procedure **2**.
- To change item to be set up, proceed to Procedure **3**.



6 Pushing **TEST** button returns the status to the normal stop status.

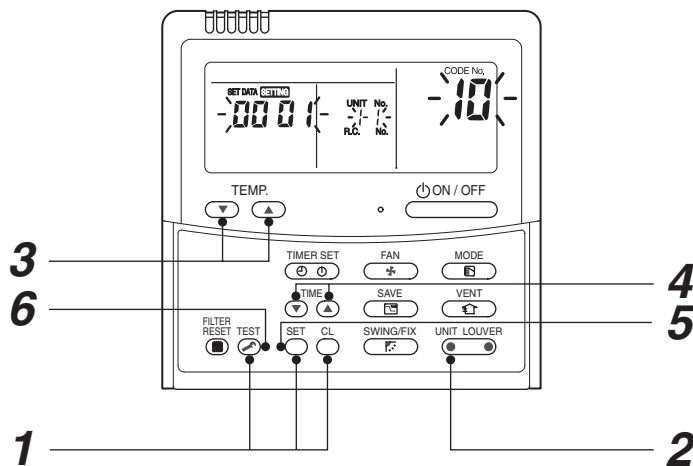

<Operation procedure>

1 → 2 → 3 → 4 → 5 → 6 END

Function CODE No. (DN Code) table (includes all functions needed to perform applied control on site)

DN	Item	Description				At shipment																				
01	Filter display delay timer	0000: None 0002: 2500H 0004: 10000H		0001: 150H 0003: 5000H		0002 : 2500H																				
02	Dirty state of filter	0000: Standard 0001: High degree of dirt (Half of standard time)				0000: Standard																				
03	Central control address	0001: No.1 unit 0099: Unfixed	to	0064: No.64 unit		0099: Unfixed																				
04	Specific indoor unit priority	0000: No priority		0001: Priority		0000: No priority																				
06	Heating temp shift	0000: 0 °C 0002: +2 °C	to	0001: +1 °C 0010: +10 °C (Up to +6 recommended)		0002 : +2°C																				
0d	Existence of [AUTO] mode	0000: Provided 0001: Not provided (Automatic selection from connected outdoor unit)				0001: Not provided																				
0F	Cooling only	0000: Heat pump 0001: Cooling only (No display of [AUTO] [HEAT])				0000: Heat pump																				
10	Type	0014 : Compact 4-way Cassette				0014 : Compact 4-way Cassette																				
11	Indoor unit capacity	0000: Unfixed		0001 to 0034		According to capacity type																				
12	Line address	0001: No.1 unit	to	0030: No.30 unit		0099: Unfixed																				
13	Indoor unit address	0001: No.1 unit	to	0064: No.64 unit		0099: Unfixed																				
14	Group address	0000: Individual 0002: Follower unit of group		0001: Header unit of group		0099: Unfixed																				
19	Louver type (Air direction adjustment)	0000: No louver 0004: (4-way Air Discharge Cassette type)		0001: Swing only		0004: (4-way Air Discharge Cassette type)																				
1E	Temp difference of [AUTO] mode selection COOL → HEAT, HEAT → COOL	0000: 0 deg	to	0010: 10 deg (For setup temperature, reversal of COOL / HEAT by } (Data value) / 2)		0003: 3 deg (Ts ±1.5)																				
28	Automatic restart of power failure	0000: None		0001: Restart		0000: None																				
2A	Selection of option/Trouble input (TCB-PCUC1E-1: CN3)	0000: Filter input 0002: None		0001: Alarm input (Air washer, etc.)		0002: None																				
2E	HA terminal (CN61) select	0000: Usual 0002: Fire alarm input		0001: Leaving-ON prevention control		0000: Usual (HA terminal)																				
31	Ventilating fan control	0000: Unavailable		0001: Available		0000: Unavailable																				
32	TA sensor selection	0000: Body TA sensor		0001: Remote controller sensor		0000: Body TA sensor																				
33	Temperature unit select	0000: °C (at factory shipment)		0001: °F		0000: °C																				
5d	High-ceiling adjustment (Air flow selection)	<table border="1"> <thead> <tr> <th>SET DATA</th> <th>Type</th> <th>RM30</th> <th>RM40</th> <th>RM56</th> </tr> </thead> <tbody> <tr> <td>0000</td> <td>Standard (factory default)</td> <td>2.7 m or less</td> <td>2.9 m or less</td> <td>3.2 m or less</td> </tr> <tr> <td>0001</td> <td>High-ceiling (1)</td> <td>—</td> <td>3.2 m or less</td> <td>3.4 m or less</td> </tr> <tr> <td>0003</td> <td>High-ceiling (3)</td> <td>—</td> <td>3.5 m or less</td> <td>3.5 m or less</td> </tr> </tbody> </table>				SET DATA	Type	RM30	RM40	RM56	0000	Standard (factory default)	2.7 m or less	2.9 m or less	3.2 m or less	0001	High-ceiling (1)	—	3.2 m or less	3.4 m or less	0003	High-ceiling (3)	—	3.5 m or less	3.5 m or less	0000: Standard
SET DATA	Type	RM30	RM40	RM56																						
0000	Standard (factory default)	2.7 m or less	2.9 m or less	3.2 m or less																						
0001	High-ceiling (1)	—	3.2 m or less	3.4 m or less																						
0003	High-ceiling (3)	—	3.5 m or less	3.5 m or less																						
60	Timer setting (wired remote controller)	0000: Available (can be performed)		0001: Unavailable (cannot be performed)		0000: Available																				
77	Dual set point	0000: Unavailable		0002: Available		0000: Unavailable																				
b3	Soft cooling	0000: Unavailable		0001: Available		0001: Available																				
b5	Occupancy sensor/ Wireless A-B selection Provided/None	0000: None 0002: Wireless remote controller provided		0001: Occupancy sensor provided		0000: None																				
b6	Occupancy sensor Enable/Invalid (Absence time judgment time)	0000: Invalid 0002: 60min. 0005; 150min.		0001: 30min. 0004; 120min.		0002: Enable (60 min.)																				

DN	Item	Description		At shipment
b7	Occupancy sensor operation at absent time	0000: Stand by	0001: operation stop	0000: Stand by
d0	Whether the power saving mode can be set by the remote controller	0000: Invalid	0001: Valid	0001: Valid
E6	Wireless remote controller A-B selection	0000: A	0001: B	0000: A
F0	Swing mode	0001 : Standard 0003 : Cycle swing	0002 : Dual swing	0001: Standard
F1	Louver fixed position (Louver No.1)	0000 : Release 0005 : Downward discharge position	0001 : Horizontal discharge position	0000: Not fixed
F2	Louver fixed position (Louver No.2)	0000 : Release 0005 : Downward discharge position	0001 : Horizontal discharge position	0000: Not fixed
F3	Louver fixed position (Louver No.3)	0000 : Release 0005 : Downward discharge position	0001 : Horizontal discharge position	0000: Not fixed
F4	Louver fixed position (Louver No.4)	0000 : Release 0005 : Downward discharge position	0001 : Horizontal discharge position	0000: Not fixed
F6	Presence of Application control kit (TCB-PCUC1E-1)	0000: None 0001: Exist		0000: None

9-1-5. Wiring and Setting of Remote Controller Control

2-remote controller control (Controlled by 2 remote controllers)

This control is to operate 1 or multiple indoor units are operated by 2 remote controllers.
(Max. 2 remote controllers are connectable.)

• When connected 2 remote controllers operate an indoor unit

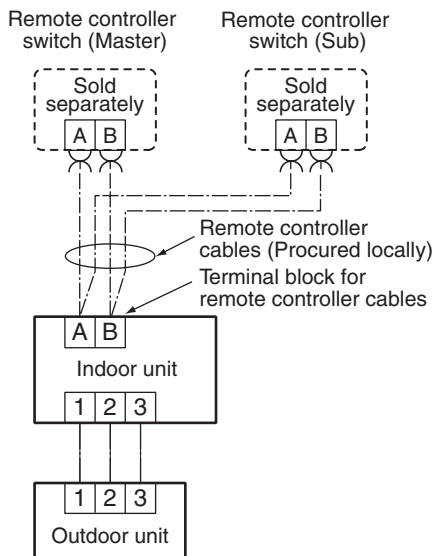

<Wired remote controller>

How to set wired remote controller as sub remote controller

Change DIP switch inside of the rear side of the remote controller switch from remote controller master to sub. (In case of RBC-AMT32E)

Remote controller (Inside of the rear side)

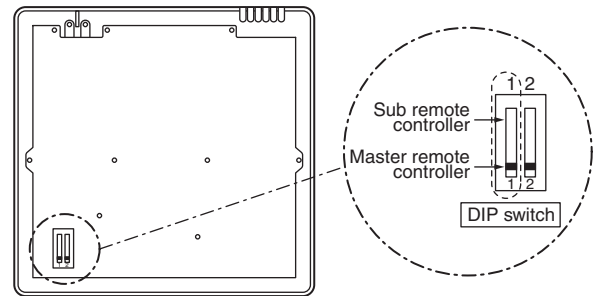

• When connected 2 remote controllers operate the twin

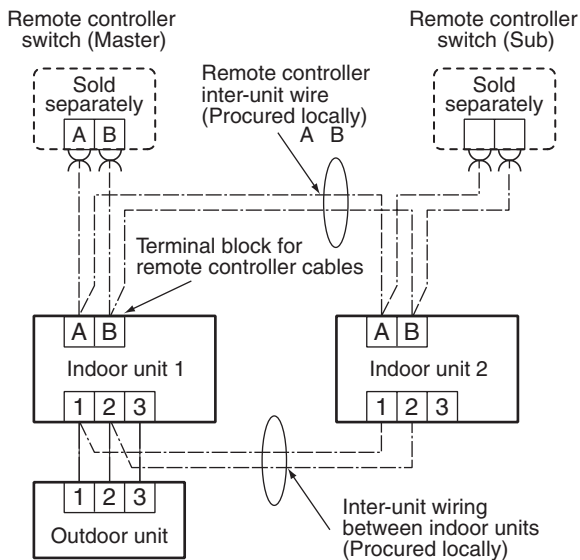

(Setup method)

One or multiple indoor units are controlled by 2 remote controllers.
(Max. 2 remote controllers are connectable.)

[Operation]



1. The operation contents can be changed by Last-push-priority.
2. Use a timer on either Master remote controller or Sub remote controller.

<Wireless remote controller>

Wireless remote controller A-B selection

Using 2 wireless remote controllers for the respective air conditioners, when the 2 air conditioners are closely installed. Address (A-B selection) must be changed on both signal receiving unit and wireless remote controller.

Wireless remote controller B setup

1. Push the START/STOP button to operate the air conditioner. Push it again to stop the air conditioner.
2. Push  [Temporary] button on the signal receiving unit to operate the air conditioner.
3. Point the wireless remote controller at the indoor unit.
4. Push and hold **CHK** ● button on the wireless remote controller by the tip of the pencil. “” will be shown on the display.
5. Push the **MODE** ● button during pushing **CHK** ●.
“B” will be shown on the display and “” will be disappear and the air conditioner will turn OFF. The wireless remote controller B is memorized.

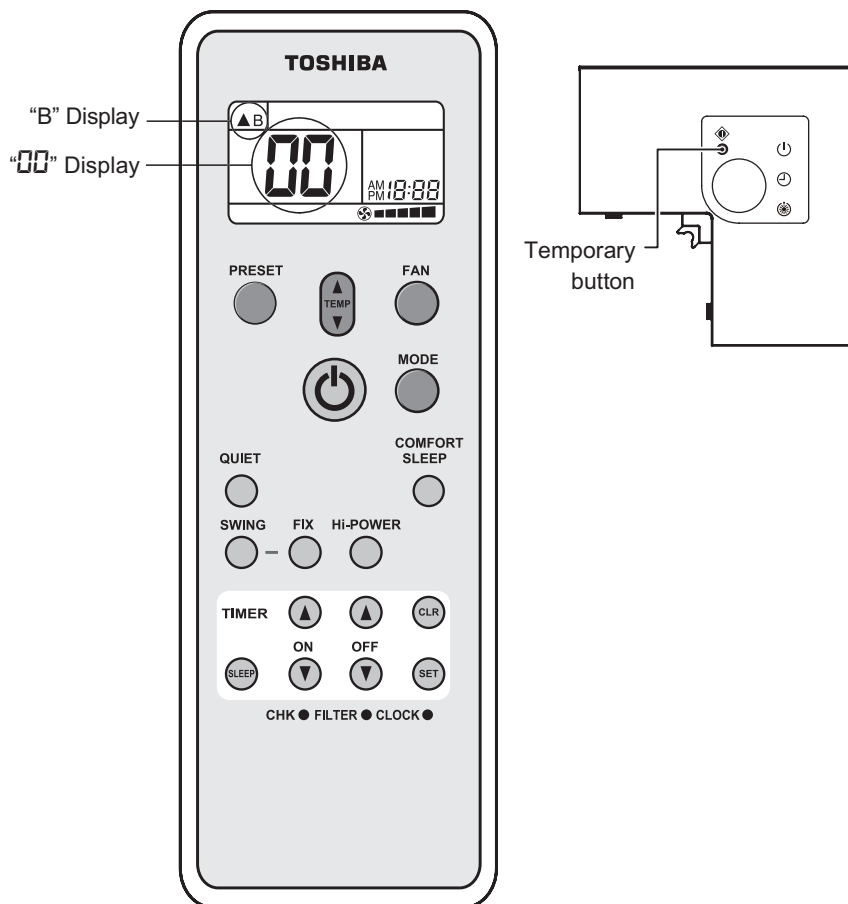

Note:

- Repeat above step to reset wireless remote controller to be A.
- The wireless remote controllers do not display “A”.
- The factory default of the wireless remote controllers is “A”.

Signal receiving unit (A-B selection) setting

1. Turn off the indoor unit power supply.
2. Remove the screw on the signal receiving unit cover and then remove the signal receiving cover.
3. Turn on the bit 3 of DIP switch SW30 on the signal receiving unit P.C. board.

9-1-6. Monitor Function of Remote Controller Switch

■ Calling of sensor temperature display

<Contents>

Each data of the remote controller, indoor unit and outdoor unit can be understood by calling the service monitor mode from the remote controller.

<Procedure>

- 1 Push **TEST** + **CL** buttons simultaneously for 4 seconds to call the service monitor mode.

The service monitor goes on, the header indoor unit No. is displayed at first and then the temperature of CODE No. **00** is displayed.



- 2 Push temperature set **TEMP.** buttons and then change the CODE No. of data to be monitored.

The CODE No. list is shown below.

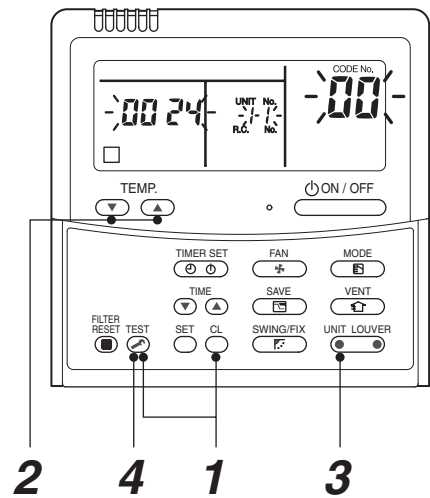

<Operation procedure>

1 → 2 → 3 → 4

Returned to usual display

	CODE No.	Data name	Unit
Indoor unit data	01	Room temperature (Remote controller)	°C
	02	Indoor suction temperature (TA)	°C
	03	Indoor heat exchanger (Coil) temperature (TCJ)	°C
	04	Indoor heat exchanger (Coil) temperature (TC)	°C
	07	Indoor fan revolution frequency	rpm
	F2	Indoor fan calculated operation time	×100h
	F3	Filter sign time	×1h

	CODE No.	Data name	Unit	
Outdoor unit data	60	Outdoor heat exchanger (Coil) temperature (TE)	°C	
	61	Outside temperature (TO)	°C	
	62	Compressor discharge temperature (TD)	°C	
	63	Compressor suction temperature (TS)	°C	
	65	Heat sink temperature (TH)	°C	
	6A	Operation current (× 1/10)	A	
	6D	Outdoor heat exchanger (Coil) temperature (TL)	°C	
	70	Compressor operation frequency	rps	
	72	Outdoor fan revolution frequency (Lower)	rpm	
	73	Outdoor fan revolution frequency (Upper)	rpm	
	F1	Compressor calculated operation time	×100h	



- 3 Push **UNIT LOUVER** (left side button) button to select the indoor unit to be monitored. Each data of the indoor unit and its outdoor units can be monitored.



- 4 Pushing **TEST** button returns the status to the usual display.

*1 The indoor discharge temperature of CODE No. **F8** is the estimated value from TC or TCJ sensor. Use this value to check discharge temperature at test run.

(A discharge temperature sensor is not provided to this model.)

- The data value of each item is not the real time, but value delayed by a few seconds to ten-odd seconds.
- If the combined outdoor unit is one before 2 or 3 series, the outdoor unit data [6D], [70], [72] and [73] are not displayed.

■ Calling of trouble history

<Contents>

The trouble contents in the past can be called.

<Procedure>

1 Push **SET** + **TEST** buttons simultaneously for 4 seconds or more to call the service check mode.

Service Check goes on, the **CODE No. 01** is displayed, and then the content of the latest alarm is displayed.

The number and trouble contents of the indoor unit in which an trouble occurred are displayed.

2 In order to monitor another trouble history, push the set temperature **TEMP** / **TEMP** buttons to change the trouble history No. (CODE No.)

CODE No. 01 (Latest) → **CODE No. 04** (Old)

NOTE : 4 trouble histories are stored in memory.

3 Pushing **TEST** button returns the display to usual display.

REQUIREMENT

Do not push **CL** button, otherwise all the trouble histories of the indoor unit are deleted. If the trouble histories are deleted by pushing **CL** button, turn off the power supply once and then turn on the power supply again. When the trouble which is same as one occurred at the last before deletion continuously occurs again, it may not be stored in memory.

(Group control operation)

In a group control, operation of maximum 8 indoor units can be controlled by a remote controller.

Twin, triple or double twin of an outdoor unit is one of the group controls.

The indoor unit connected with outdoor unit (Individual/Header of twin) controls room temperature according to setting on the remote controller.

<System example>

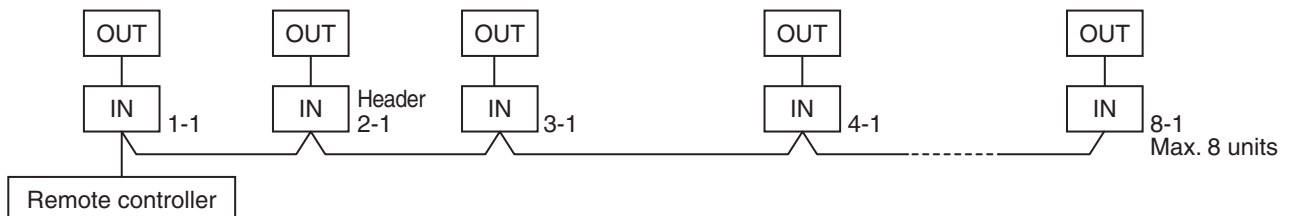

1. Display range on remote controller

The setup range (Operation mode/Air volume select/Setup temp) of the indoor unit which was set to the header unit is reflected on the remote controller.

1) Concealed duct high static pressure type is not set up on the header unit.

- If the Concealed duct high static pressure type is the header unit:

Operation mode: [Cooling/Heating AUTO] [HEAT] [COOL] [FAN] and no [DRY]
Air volume select: [HIGH]

- When the operation mode is [DRY], [FAN] stops in concealed duct high static pressure models.

2. Address setup

If there is no serial communication between indoor and outdoor when the power is turned on, it is judged as follower unit of the twin. (Every time when the power is turned on)

- The judgment of header (wired) / follower (simple) of twin is carried out every time. It is not stored in nonvolatile memory.

Turn on power of the indoor unit to be controlled in a group within 3 minutes after setting of automatic address.

If power of the indoor unit is not turned on within 3 minutes (completion of automatic address setting), the system is rebooted and the automatic address setting will be judged again.

1) Connect indoor/outdoor connecting wire surely.

2) Check line address/indoor address/group address of the unit one by one.

Especially in case of twin, triple, double twin, check whether they are identical system address or not.

3) The unit No. (line/indoor gout address) which have been set once keep the present status as a rule if the unit No. is not duplicated with one of another unit.

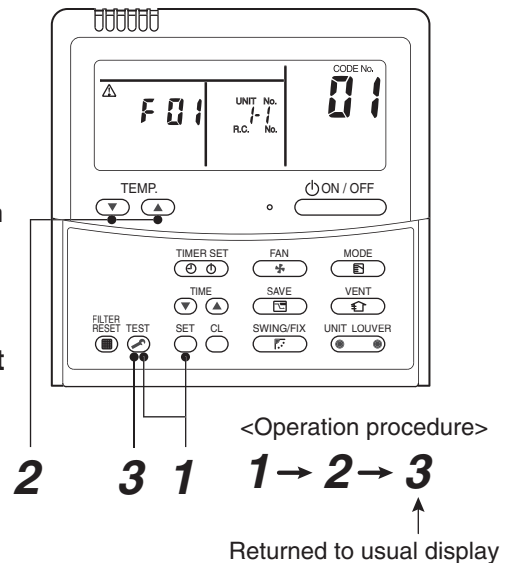

Indoor unit power-ON sequence

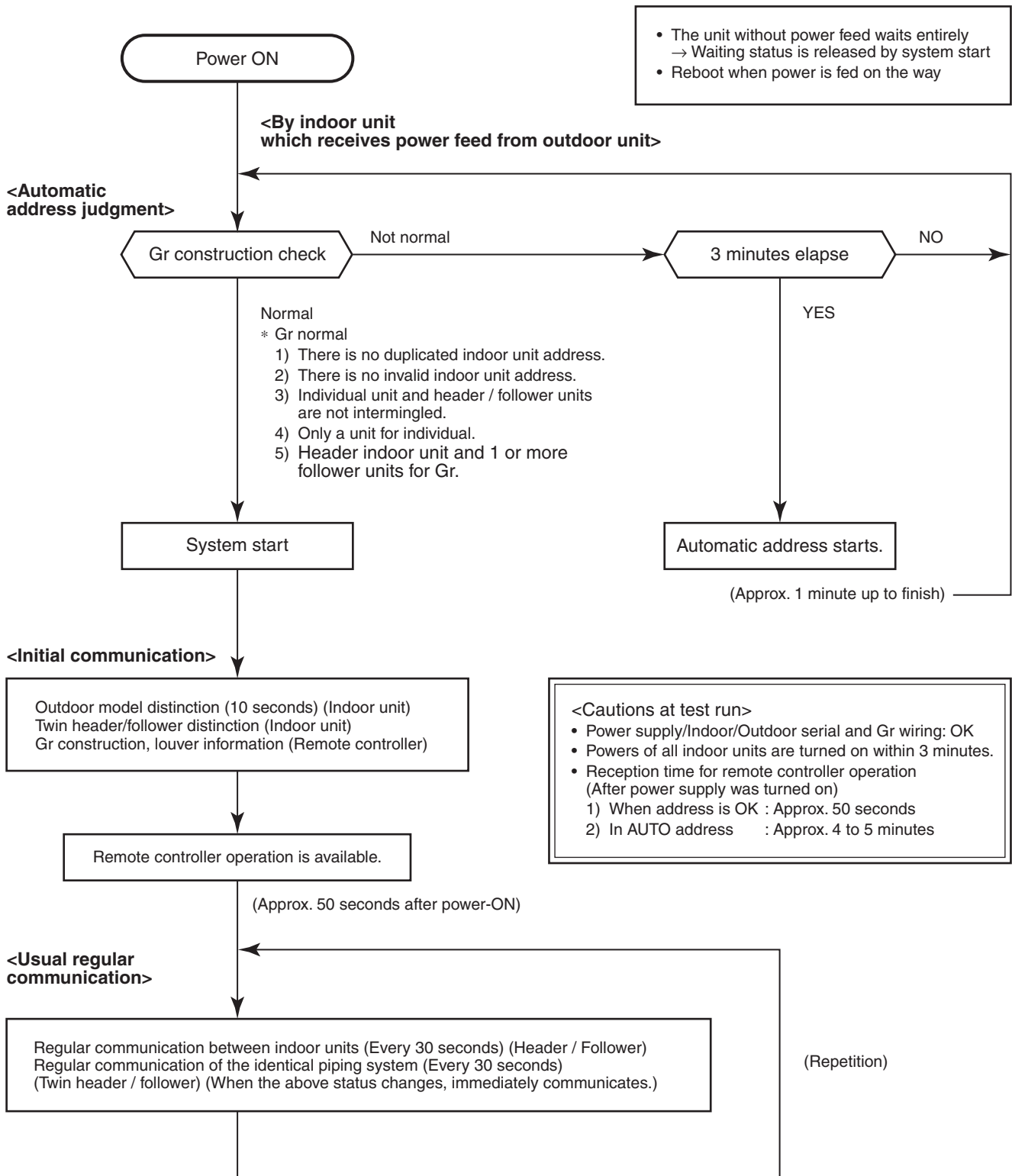

- In a group operation, if the indoor unit which was fed power after judgment of automatic address cannot receive regular communication from the header unit and regular communication on identical pipe within 120 seconds after power was turned on, it reboots (system reset).

→ The operation starts from judgment of automatic address (Gr construction check) again.

(If the address of the header unit was determined in the previous time, the power fed to the header unit and reboot works, the header unit may change though the indoor unit line address is not changed.)

9-2. Setup at Local Site / Others

Model name: TCB-PCNT30TLE2

9-2-1. 1:1 Model Connection Interface (TCC-LINK adapter)

1. Function

This model is an optional P.C. board to connect the indoor unit to 1:1 model connection interface.

2. Microprocessor block diagram

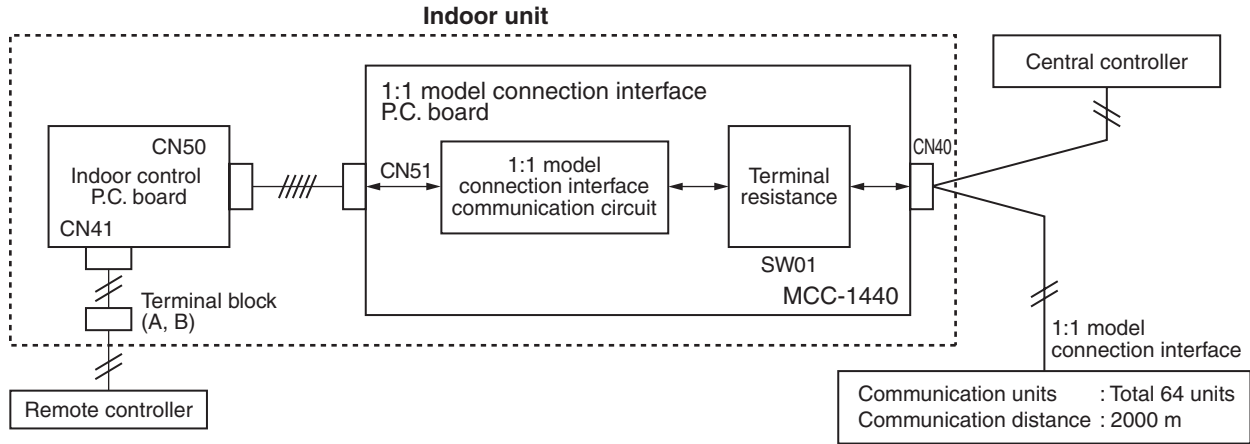

3. 1:1 model connection interface wiring connection

⚠ CAUTION

- 1) When controlling DI, SDI series collectively, 1:1 model connection interface (This option) is required.
- 2) In case of group operation, twin-triple operation, the 1:1 model connection interface is necessary to be connected to the header unit.
- 3) Connect the central control devices to the central control system wiring.
- 4) When controlling DI, SDI series only, turn on only Bit 1 of SW01 of the least line of the system address No. (OFF when shipped from the factory)

*** In case of DI, SDI series, the address is necessary to be set up again from the wired remote controller after automatic addressing.**

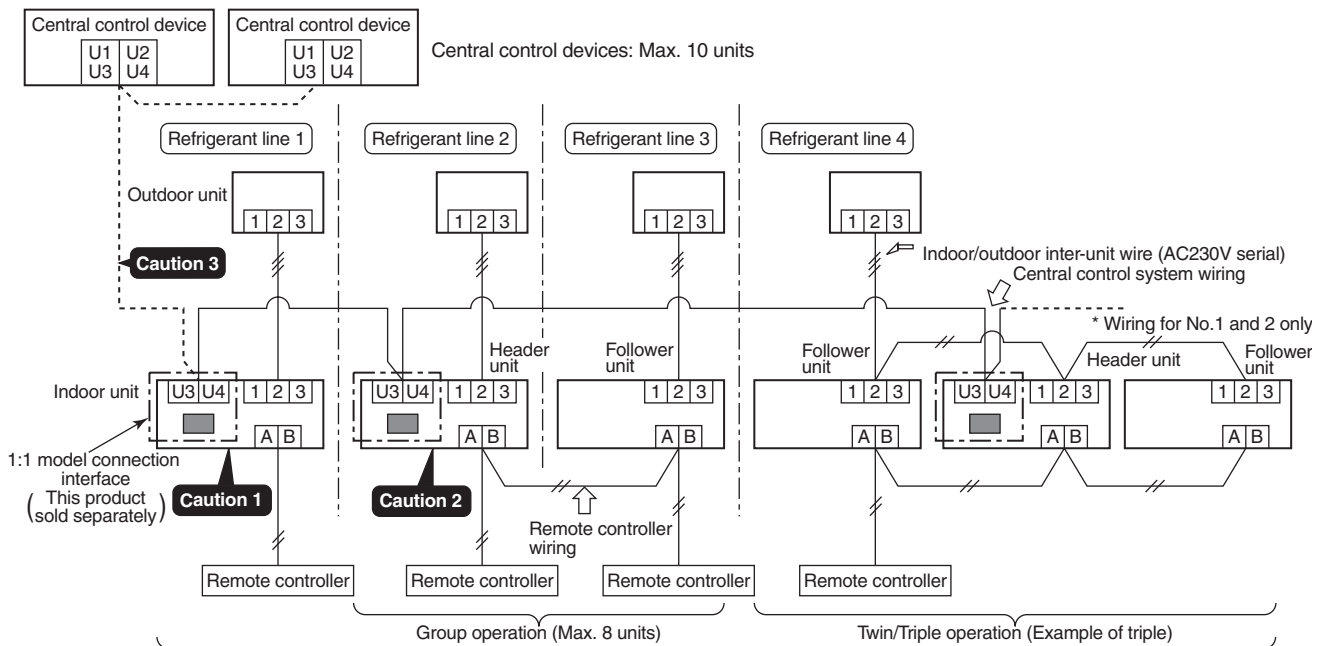

Indoor units in all refrigerant lines: Max. 64 units
 [If mixed with SMMS (Link wiring), multi indoor units are included.]
 * However group follower units of SDI, DI series are not included in number of the units.

4. Wiring Specifications

- Use 2-core with no polar wire.
- Match the length of wire to wire length of the central control system. If mixed in the SMMS system, the wire length is lengthened with all indoor/outdoor inter-unit wire length at side.
- To prevent noise trouble, use 2-core shield wire.
- Connect the shield wire by closed-end connection and apply open process (insulating process) to the last terminal. Ground the earth wire to 1 point at indoor unit side. (In case of central controlling of digital inverter (DI, SDI) unit setup)

No. of wires	Size
2	Up to 1000m: twisted wire 1.25mm ² Up to 2000m: twisted wire 2.0mm ²

⚠ CAUTION

- 1) Closed-end connection of shield wire (Connect all the connecting parts of each indoor unit)
- 2) Apply open process to the last terminal (insulating process).
- 3) Ground earth wire to 1 point at indoor unit side.

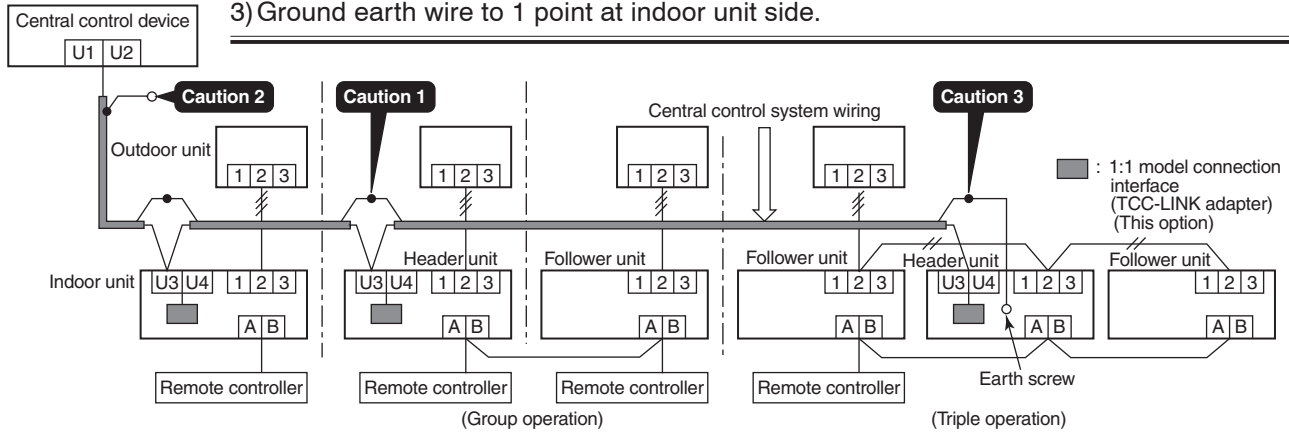

5. P.C. Board Switch (SW01) Setup

When performing collective control by customized setup only, the setup of terminator is necessary.

- Using SW01, set up the terminator.
- Set up the terminator to only the interface connected to the indoor unit of least line address No.

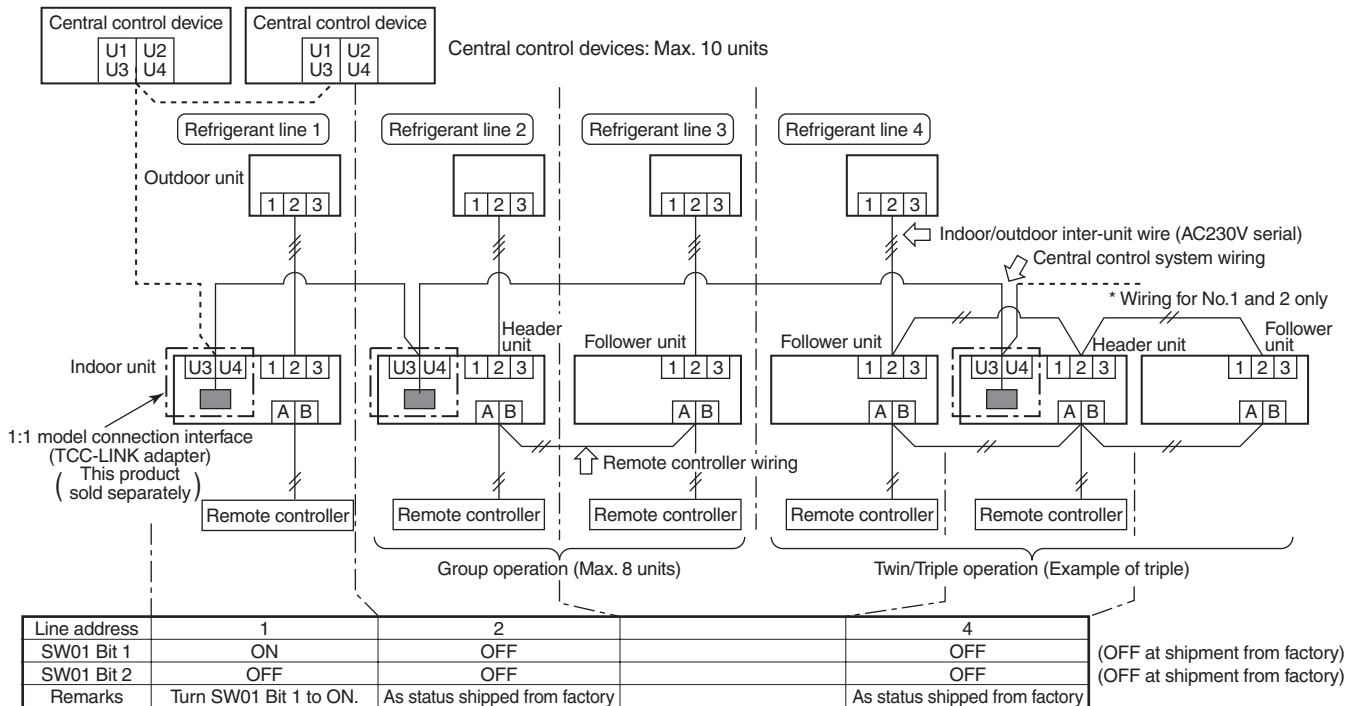

(Reference) Setup contents of switch

SW01		Terminator	Remarks
Bit 1	Bit 1		
OFF	OFF	None	Mixed with SMMS (Link wiring) at shipment from factory
ON	OFF	100Ω	Central control by digital inverter only
OFF	ON	75Ω	Spare
ON	ON	43Ω	Spare

6. External view of P.C. board assembly

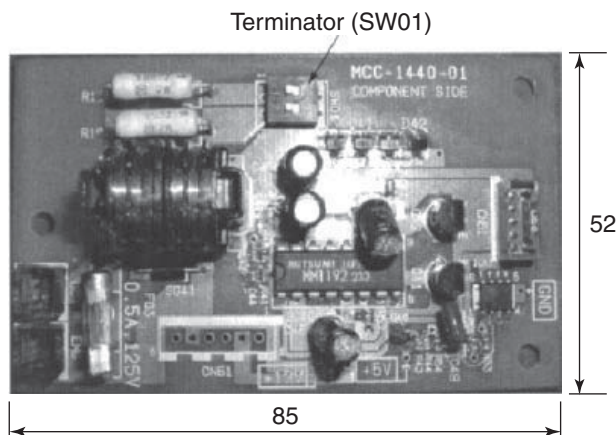

7. Address setup

In addition to set up the central control address, it is necessary to change the indoor unit number. (Line/Indoor/Group address). For details, refer to 1:1 model connection interface Installation Manual.

9-3. How to Set up Central Control Address Number

When connecting the indoor unit to the central control remote controller using 1:1 model connection interface, it is necessary to set up the central control address number.

- The central control address number is displayed as the line No. of the central control remote controller.

How to set up from indoor unit side by remote controller

<Procedure> Perform setup while the unit stops.

1 Push + buttons for 4 seconds or more.

When group control is executed, first the unit No. is displayed and all the indoor units in the group control are selected. In this time, fans of all the selected indoor units are turned on. (Fig. 1)
(Keep displayed status without pushing button (button of the left side).)

In case of individual remote controller which is not group-controlled, Line address and Indoor unit address are displayed.

2 Using temperature setup buttons, specify CODE No. 03.

3 Using timer time buttons, select the SET DATA. The setup data is shown in the table below (Table 1).

4 Push button. (OK if display goes on.)

- To change the item to be set up, return to Procedure 2.

5 Push button.

The status returns to usual stop status.

(Table 1)

SET DATA	Central control address No.
0001	1
0002	2
0003	3
⋮	⋮
0064	64
0099	Unset (Setup at shipment from factory)

(Fig.1)

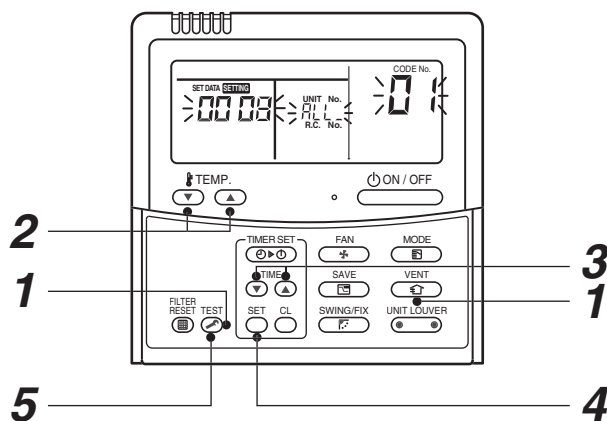

10. ADDRESS SETUP

10-1. Address Setup

<Address setup procedure>

When an outdoor unit and an indoor unit are connected and they are twin-triple, or when an outdoor unit is connected to each indoor unit respectively in the group operation even if multiple refrigerant lines are provided, the automatic address setup completes with power-ON of the outdoor unit. The operation of the remote controller is not accepted while automatic address works. (Approx. 4 to 5 minutes)

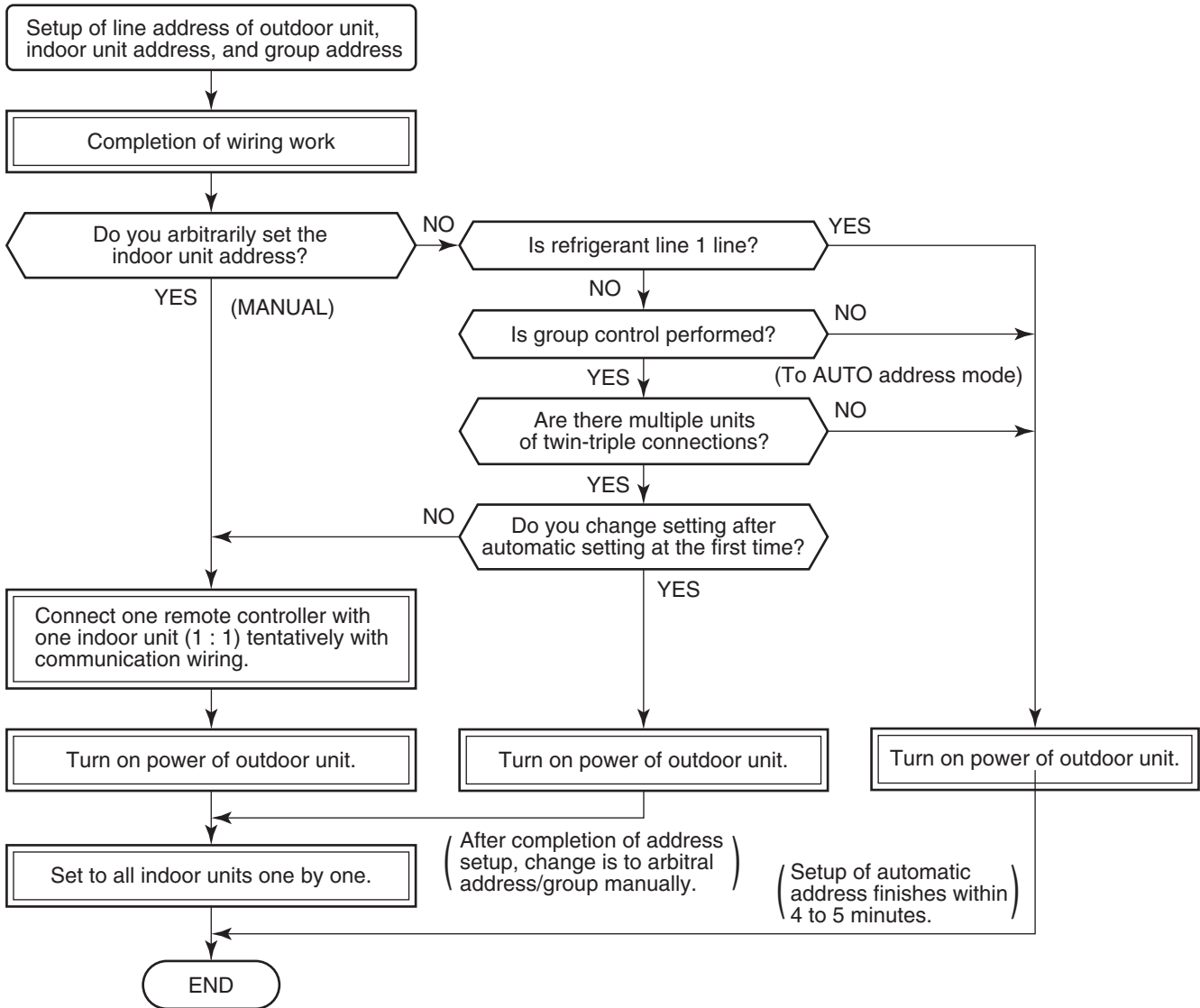

- When the following addresses are not stored in the neutral memory (IC10) on the indoor P.C. board, a test run operation cannot be performed. (Unfixed data at shipment from factory)

	CODE No.	Data at shipment	SET DATA range
Line address	12	0099	0001 (No. 1 unit) to 0030 (No. 30 unit)
Indoor unit address	13	0099	0001 (No. 1 unit) to 0064 (No. 64 unit) Max. value of indoor units in the identical refrigerant line (Double twin = 4)
Group address	14	0099	0000 : Individual (Indoor units which are not controlled in a group) 0001 : Header unit (1 indoor unit in group control) 0002 : Follower unit (Indoor units other than header unit in group control)

10-2. Address Setup & Group Control

<Terminology>

- Indoor unit No. : $N - n =$ Outdoor unit line address N (Max. 30) – Indoor unit address n (Max. 64)
- Group address : 0 = Single (Not group control)
1 = Header unit in group control
2 = Follower unit in group control
- Header unit (= 1) : The representative of multiple indoor units in group operation sends/receives signals to/from the remote controllers and follower indoor units.
(*It has no relation with an indoor unit which communicates serially with the outdoor units.)
The operation mode and setup temperature range are displayed on the remote controller LCD. (Except air direction adjustment of louver)
- Follower unit (= 2) : Indoor units other than header unit in group operation
Basically, follower units do not send/receive signals to/from the remote controllers.
(Except trouble and response to demand of service data)
- Master unit (Header Twin) : This unit communicates with the indoor unit (sub) which serial-communicates with the outdoor units and sends/receives signal (Command from compressor) to/from the outdoor units as the representative of the cycle control in the indoor units of the identical line address within the minimum unit which configures one of the refrigerating cycles of Twin, Triple, Double twin.
- Sub unit (Subordinate unit) (Follower Twin) : Indoor units excluding the header unit in Twin, Triple, Double twin
This unit communicates with (Header) indoor unit in the identical line address and performs control synchronized with (Header) indoor unit.
This unit does not perform the signal send/receive operation with the outdoor units.:
 N judgment for serial signal trouble.

10-2-1. System configuration

1. Single

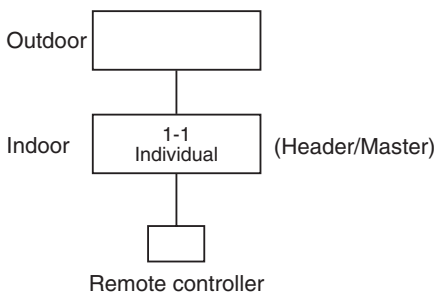

2. Twin

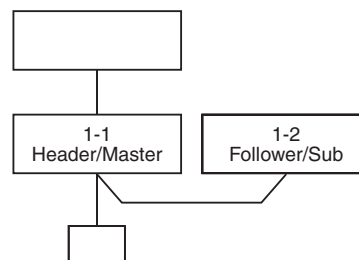

3. Triple

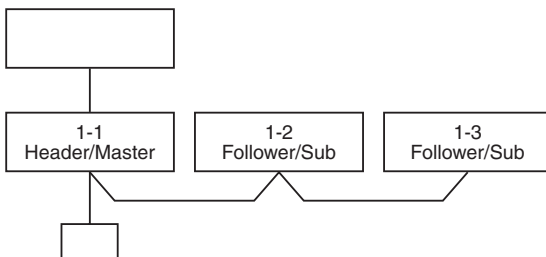

4. Double twin

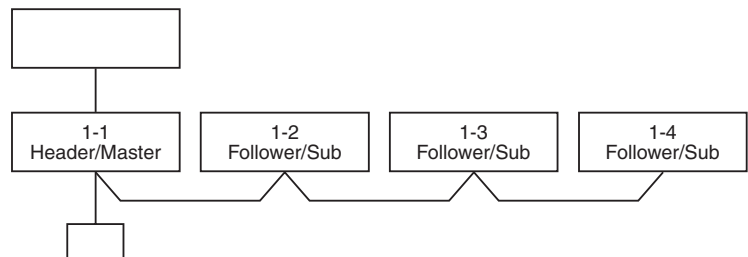

4. Single group operation

- Each indoor unit controls the outdoor unit individually.

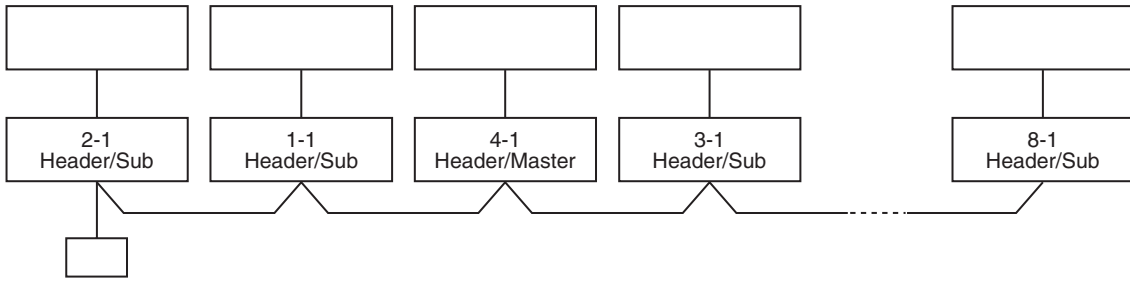

5. Multiple groups operation (Manual address setting)

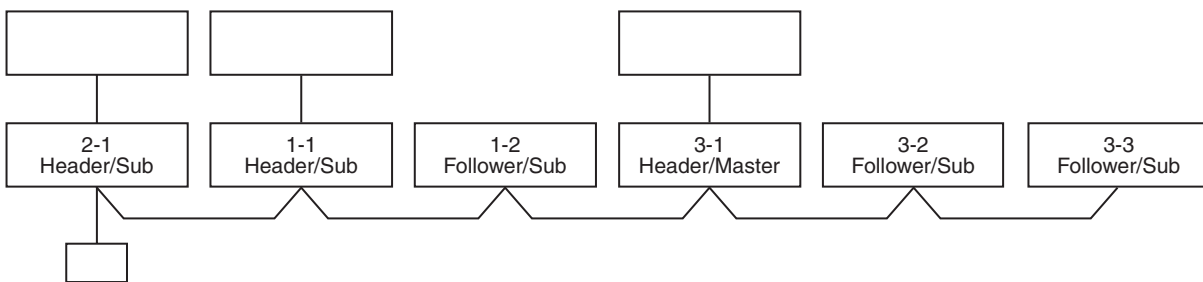

- Master unit: The master unit receives the indoor unit data (thermo status) of the sub (Without identical line address & indoor/outdoor serial) and then finally controls the outdoor compressor matching with its own thermo status.
The master unit sends this command information to the sub unit.
- Sub unit: The sub unit receives the indoor unit data from the master (With identical line address & indoor/outdoor serial) and then performs the thermo operation synchronized with the master unit.
The sub unit sends own thermo ON/OFF demand to the master unit.

(Example)

No. 1-1 master unit sends/receives signal to/from No. 1-2 and No. 1-3 sub units.
(It is not influenced by the line 2 or 3 address indoor unit.)

10-2-2. Automatic Address Example from Unset Address (No miswiring)

1. Standard (One outdoor unit)

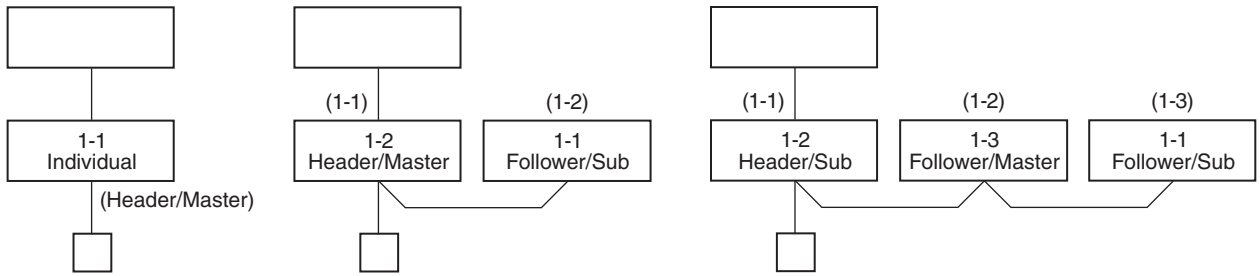

Only turning on source power supply (Automatic completion)

2. Group operation

(Multiple outdoor units = Multiple indoor units with serial communication only, without twin)

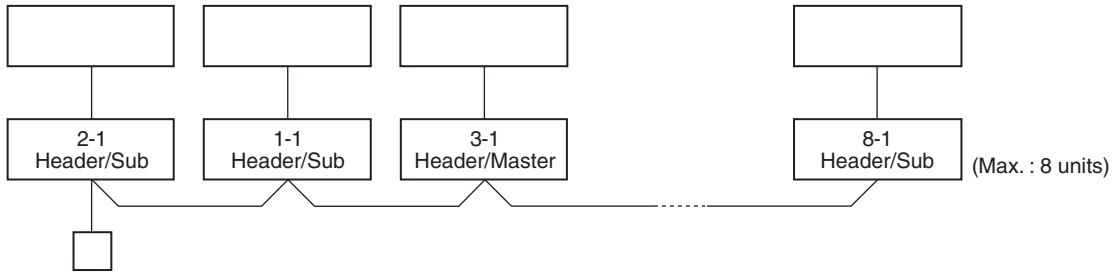

Only turning on source power supply (Automatic completion)

3. Multiple groups operation

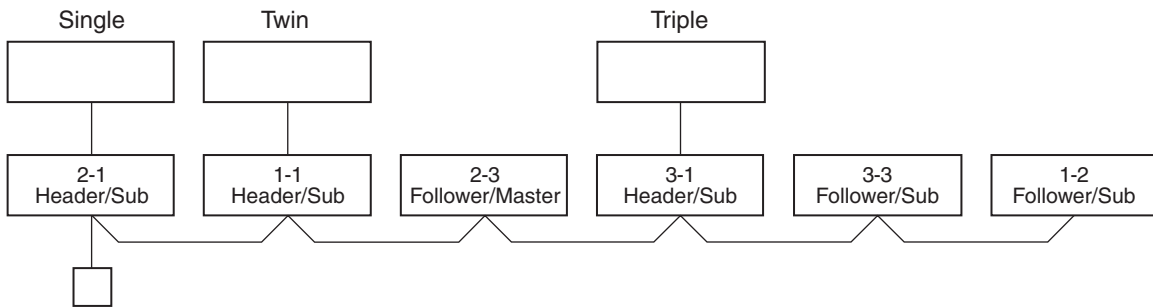

Change is necessary
Manually change addresses of the multiple sub units
simultaneously from the remote controller.

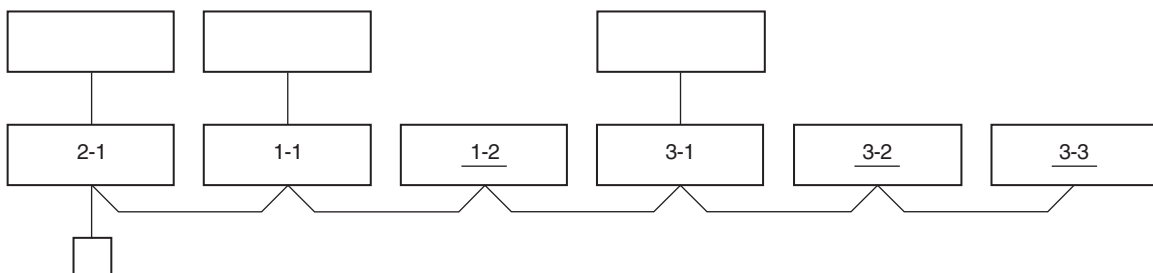

10-3. Address Setup (Manual Setting from Remote Controller)

In case that addresses of the indoor units will be determined prior to piping work after wiring work

- Set an indoor unit per a remote controller.
- Turn on power supply.

(Example of 2-lines wiring)
(Real line: Wiring, Broken line: Refrigerant pipe)

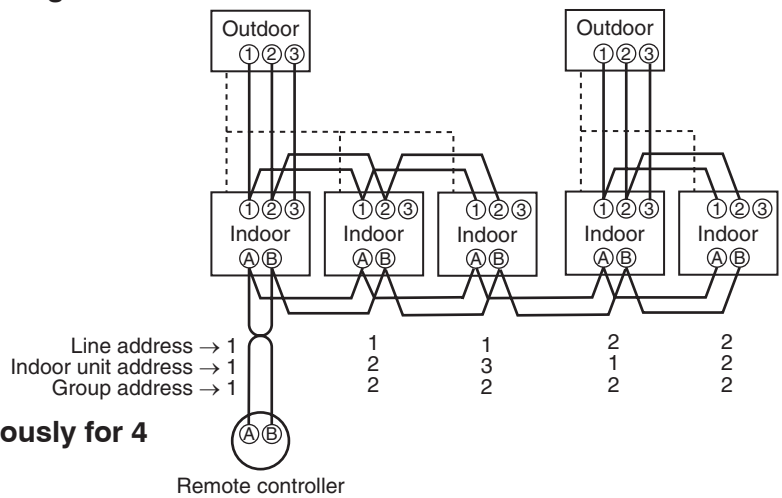

1 Push **SET** + **CL** + **TEST** buttons simultaneously for 4 seconds or more.

2 (Line address)
Using the temperature setup **▼** / **▲** buttons, set **12** to the CODE No.

3 Using timer time **▼** / **▲** buttons, set the line address.

4 Push **SET** button. (OK when display goes on.)

5 (Indoor unit address)
Using the temperature setup **▼** / **▲** buttons, set **13** to the CODE No.

6 Using timer time **▼** / **▲** buttons, set 1 to the line address.

7 Push **SET** button. (OK when display goes on.)

8 (Group address)
Using the temperature setup **▼** / **▲** buttons, set **14** to the CODE No.

9 Using timer time **▼** / **▲** buttons, set **0000** to Individual, **0001** to Header unit, and **0002** to Follower unit.

10 Push **SET** button. (OK when display goes on.)

11 Push **TEST** button.

Setup completes. (The status returns to the usual stop status.)

For the above example, perform setting by connecting singly the wired remote controller without remote controller inter-unit wire.

Group address
Individual : 0000
Header unit : 0001
Follower unit : 0002 } In case of group control

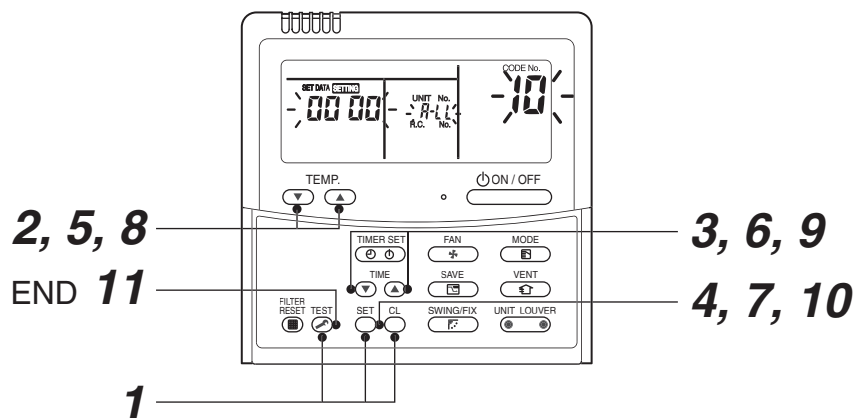

<Operation procedure>

1 → 2 → 3 → 4 → 5 → 6 → 7 → 8 → 9 → 10 → 11 END

10-4. Confirmation of Indoor Unit No. Position

1. To know the indoor unit addresses though position of the indoor unit body is recognized

- In case of individual operation (Wired remote controller : indoor unit = 1 : 1)
(Follow to the procedure during operation)

<Procedure>

1 Push  button if the unit stops.

2 Push  button (button of the left side).

Unit No. 1-1 is displayed on LCD.

(It disappears after several seconds.)

The displayed unit No. indicate line address and indoor unit address. (When other indoor units are connected to the identical remote controller (Group control unit), other unit numbers are also displayed every pushing  button (button of the left side).

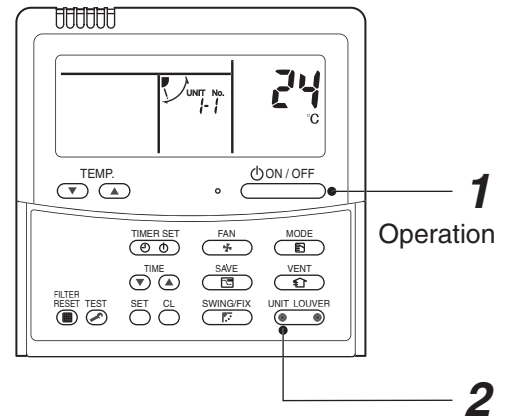

<Operation procedure>

1 → 2 END

2. To know the position of indoor unit body by address

- To confirm the unit No. in the group control
(Follow to the procedure during operation) (in this procedure, the indoor units in group control stop.)

<Procedure>

The indoor unit numbers in the group control are successively displayed, and fan, louver, and drain pump of the corresponding indoor unit are turned on.
(Follow to the procedure during operation)

1 Push  and  buttons simultaneously for 4 seconds or more.

- Unit No. ALL is displayed.
- Fans and louvers of all the indoor units in the group control operate.

2 Every pushing  button (button of the left side), the unit numbers in the group control are successively displayed.

- The unit No. displayed at the first time indicates the header unit address.
- Fan and louver of the selected indoor unit only operate.

3 Push  button to finish the procedure.
All the indoor units in the group control stop.

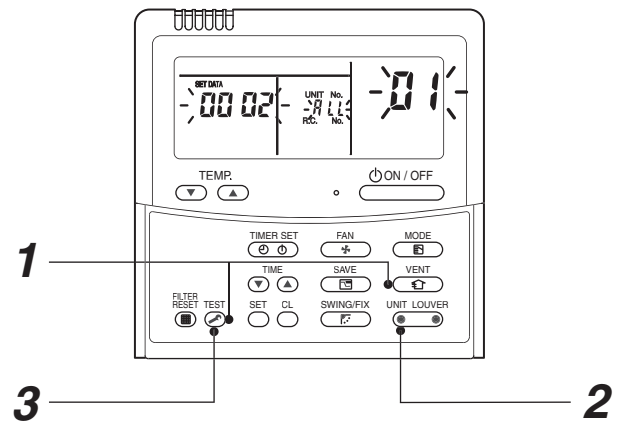

<Operation procedure>

1 → 2 → 3 END

<Maintenance/Check list>

Aiming in environmental preservation, it is strictly recommended to clean and maintain the indoor/outdoor units of the operating air conditioning system regularly to secure effective operation of the air conditioner.

It is also recommended to maintain the units once a year regularly when operating the air conditioner for a long time.

Check periodically signs of rust or scratches, etc. on coating of the outdoor units.

Repair the defective position or apply the rust resisting paint if necessary.

If an indoor unit operates for approx. 8 hours or more per day, usually it is necessary to clean the indoor/outdoor units once three months at least.

These cleaning and maintenance should be carried out by a qualified dealer.

Although the customer has to pay the charge for the maintenance, the life of the unit can be prolonged.

Failure to clean the indoor/outdoor units regularly will cause shortage of capacity, freezing, water leakage or trouble on the compressor.

Part name	Object		Contents of check	Contents of maintenance
	Indoor	Outdoor		
Heat exchanger	○	○	• Blocking with dust, damage check	• Clean it when blocking is found.
Fan motor	○	○	• Audibility for sound	• When abnormal sound is heard
Filter	○	—	• Visual check for dirt and breakage	• Clean with water if dirty • Replace if any breakage
Fan	○	○	• Visual check for swing and balance • Check adhesion of dust and external appearance.	• Replace fan when swinging or balance is remarkably poor. • If a large dust adheres, clean it with brush or water.
Suction/ Discharge grille	○	—	• Visual check for dirt and scratch	• Repair or replace it if deformation or damage is found.
Drain pan	○	—	• Check blocking by dust and dirt of drain water.	• Clean drain pan, Inclination check
Face panel, Louver	○	—	• Check dirt and scratch.	• Cleaning/Coating with repair painting
External appearance	—	○	• Check rust and peeling of insulator • Check peeling and floating of coating film	• Coating with repair painting





11. DETACHMENTS

⚠ WARNING

Be sure to stop operation of the air conditioner before work and then turn off switch of the breaker.

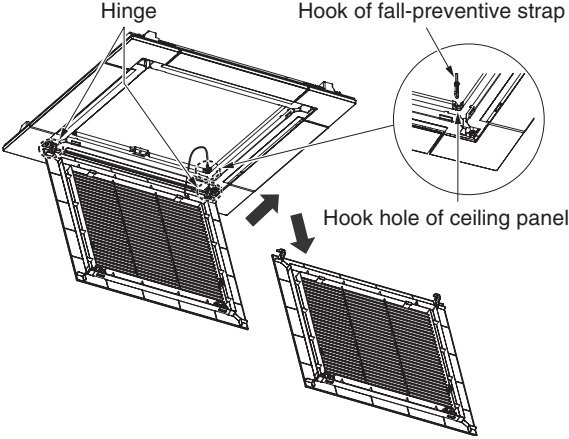
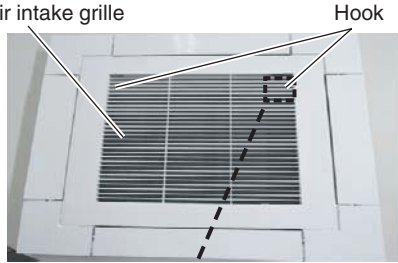
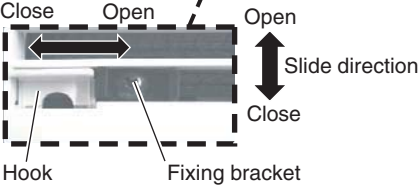
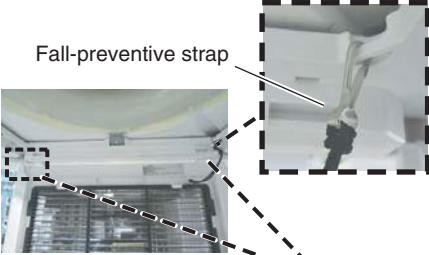

⚠ CAUTION

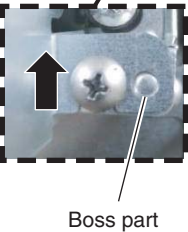

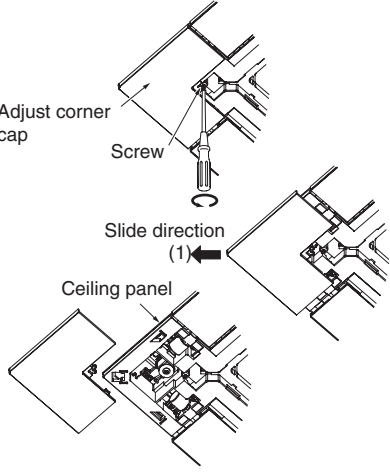
Be sure to put on gloves during working time; otherwise an injury will be caused by a part etc.

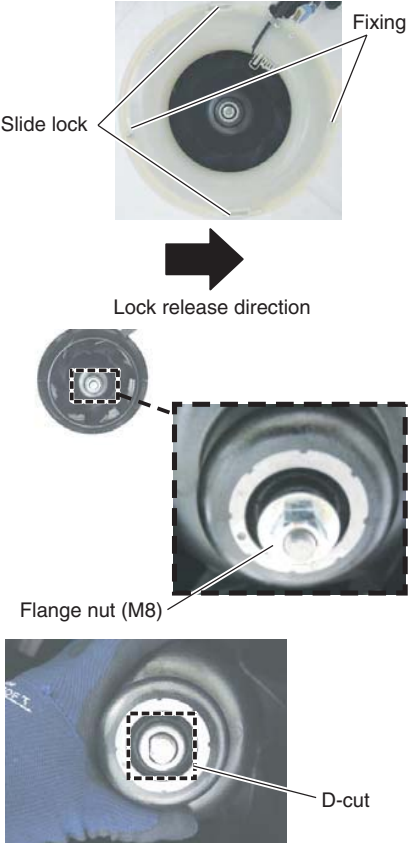

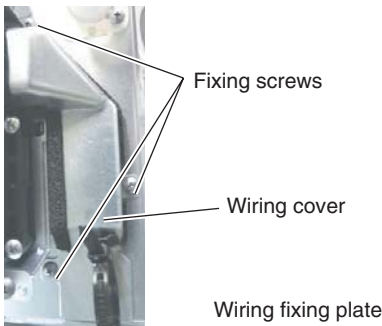
No.	Part name	Procedure	Remarks
①	Air intake grille	<p>1. Detachment</p> <ol style="list-style-type: none"> 1) Stop operation of the air conditioner and then turn off switch of the circuit breaker. 2) Loosen the fixing screw. And slide the fixing bracket toward the inside. (Ø4 × 8, 1 pcs.) 3) Holding the air intake grille, slide the hook in the direction of the arrow and slowly open the grille. 4) Remove the hook of the fall-preventive strap from the ceiling panel. Remove the hinge section of the air intake grille from the ceiling panel while the air intake grille is opened. <p>2. Attachment</p> <ol style="list-style-type: none"> 1) Hook the hinge of the air intake grille to the main panel, and then attach the fall-preventive strap. 2) Close the air intake grille, and then slide the hook. 3) Slide the grille fixing bracket to fix it with the screws. (Ø4 × 8, 1pc.) 	   
②	Electric parts cover	<p>1. Detachment</p> <ol style="list-style-type: none"> 1) Loosen the fixing screws (2 places) of the electric parts cover. (Ø4 × 8, 2 pcs.) 2) Slide the electric parts cover toward upper side to remove it. <p>2. Attachment</p> <ol style="list-style-type: none"> 1) Slide the electric parts cover to attach it. (Arrange the boss at the electric parts side just on the boss hole at the cover side.) 2) Tighten the screws of the electric parts cover (2 positions) to fix it. (Ø4 × 8, 2 pcs.) 	  

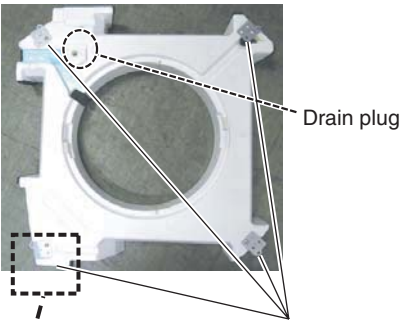
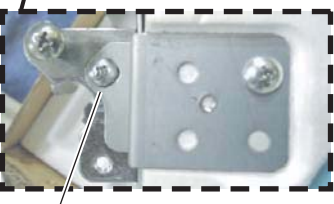
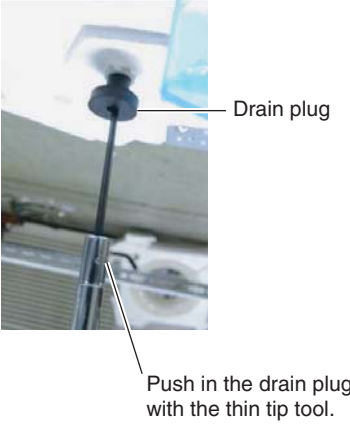
No.	Part name	Procedure	Remarks
③	Adjust corner cap	<p>1. Detachment</p> <ol style="list-style-type: none"> 1) Remove the air intake grille. (Refer to 1 of ①.) 2) Loosen the fixing screws on the adjust corner cap. (Ø4 × 12, 4 pcs.) 3) Slide the adjust corner cap to outside to remove it. <p>2. Attachment</p> <ol style="list-style-type: none"> 1) Matching claws (5 positions) of the adjust corner cap to holes of the panel main unit holes and attach them. 2) Tighten the fixing screws of the adjust corner cap (Ø4 × 12, 4 pcs.). <p>NOTE</p> <p>Tighten the screw with a hand screwdriver and do not use a tool such as an electric screwdriver. Tightening torque : 1 N•m or less</p>	
④	Ceiling panel	<p>1. Detachment</p> <ol style="list-style-type: none"> 1) Remove the air intake grille and the adjust corner cap. (Refer to 1 of ① and 1 of ③.) 2) Remove the louver motor connector. 3) By sliding the panel fixing bracket of the corner part, remove it from the fixing screws. (Total 4 positions) 4) Push the tentative hanging hook at the center part of the ceiling panel main body toward the outside of the ceiling panel, and then remove the ceiling panel from the indoor unit. <p>2. Attachment</p> <ol style="list-style-type: none"> 1) Match the louver motor connector of the ceiling panel so that it directs to the electric parts side, and then hook the tentative hanging hook at the center part of the ceiling panel main body to the bell mouth. 2) Connect the louver motor connectors at the ceiling panel side and the indoor unit side. 3) Lift up the panel corner part and put out the screw head of the panel fixed implement. Slide the panel fixed bracket, and then fix the indoor unit and the ceiling panel. (Total 4 positions). * In case of loosening screws of the panel fixed implement so that screw head is out under the panel fixed implement, retighten the screws after work. 4) Following to the works in items ③-2 and ①-2, attach the adjust corner cap and the air intake grille as original. <p>NOTE</p> <ul style="list-style-type: none"> • The ceiling panel aligns directionally with the indoor unit. Check that the lead wires of louver motor connector are on the electrical control box side. • When a clearance is found between the ceiling surface and the ceiling panel, readjust height of the indoor unit even if the screws have been tightened. 	

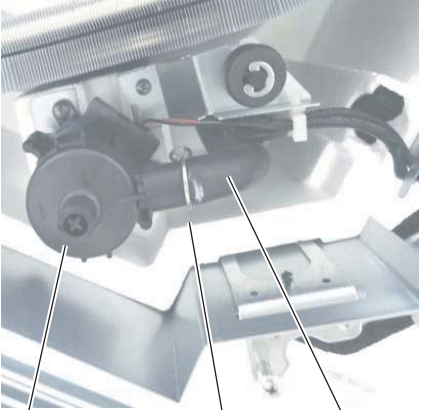
No.	Part name	Procedure	Remarks
⑤	Control P.C. board	<p>1. Detachment</p> <ol style="list-style-type: none"> 1) Remove the electric parts cover. (Refer to 1 of ②) 2) Remove connectors which are connected from the control P.C. board to the other parts and then remove wiring from the clamp. <p>NOTE</p> <hr/> <p>Unlock the lock of the housing part and then remove the connector.</p> <hr/> <p>CN34 : Float switch (3P, Red) CN41 : Remote controller (2P, Blue) CN40 : Control wires (2P, Blue) CN67 : Power supply wires (5P, Black) CN101 : TC sensor (2P, Black) CN102 : TCJ sensor (2P, Red) CN104 : Room temp. (TA) sensor (2P, Yellow) CN510 : Louver motor (20P, White) CN504 : Drain pump (2P, White) CN210 : Fan motor (7P, White) CN22 : Earth wire (Tab terminal)</p> <ol style="list-style-type: none"> 3) Unlock the locks of the card edge spacer (4 positions) and remove the control P. C. board. <p>2. Attachment</p> <ol style="list-style-type: none"> 1) Fix the control board to the card edge spacer (4 positions). 2) Connect the removed connectors as original, which were unconnected in item 1. Detachment, and fix the wires with clamps. 3) Following to the work in ②-2, attach the electric parts covers as original. 	 <p>Clamp Card edge spacer</p>
⑥	Turbo fan	<p>1. Detachment</p> <ol style="list-style-type: none"> 1) Remove the air intake grille. (Refer to 1 of ①.) 2) Loosen the fix screws (2 positions) of the bell mouth, rotate the bell mouth, and then take off it. (Ø4 × 10, 2 pcs.) 3) Loosen the flange nut (M8) at the center part of the turbo fan, and then take off (Counter clockwise) * Supporting with hands, take off the turbo fan so that it will not fall down. <p>NOTE</p> <hr/> <p>Use a box wrench for attachment and detachment of the turbo fan. If using monkey wrench etc., the other parts may be damaged in work.</p> <hr/> <p>2. Attachment</p> <ol style="list-style-type: none"> 1) Match the D-cut of the motor shaft with the boss part D-cut of the turbo fan, and then insert the turbo fan into the motor shaft. 2) Tighten M8 nut with flange. (Tightening torque of the turbo fan: 5.4+0.5, -0.2N•m) 3) Slide the Bell mouth removed in item 1-2) and attach it then fix it with screws. (Ø4 × 10, 2 pcs.). 4) Following to the work in item ①-2, attach the air intake grille as original. <p>NOTE</p> <hr/> <p>(Tightening torque of the turbo fan: 5.4 (+0.5, -0.2)N•m)</p>	 <p>Slide lock Fixing</p> <p>Lock release direction</p> <p>Flange nut (M8)</p> <p>D-cut</p>

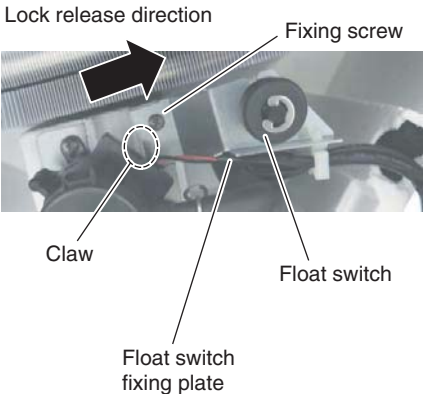
No.	Part name	Procedure	Remarks
⑦	Drain pan	<p>1. Detachment</p> <ol style="list-style-type: none"> Remove the ceiling panel and the electrical parts covers. (Refer to items ④-1 and ②-1.) Remove the wiring cover. (Fixing screw $\varnothing 4 \times 8$, 3pcs.) Remove the wiring fixing plate. (Fixing screw $\varnothing 4 \times 8$, 1pc, $\varnothing 4 \times 10$, 1pc.) Remove the connectors of the fan motor lead wire, louver motor lead wire, and room temperature (TA) sensor from the control P.C. board, and then remove the wiring from the clamp. * Pull out the wires from the hole at the side face of the electric parts. CN210: Fan motor (7P, White) CN510: Louver motor lead wire (20P, White) CN104: TA (Room temperature) sensor (2P, Yellow) Remove the drain plug of the drain pan, and extract the stayed drain water. * Be careful that water is extracted at a stretch when taking off the drain plug. * When taking off the drain plug, be sure to prepare a bucket, etc. for spilled water. Remove the fixing screws of the drain pan fixing bracket. ($\varnothing 4 \times 8$, 4 pcs.) Using the both hands, hold the water-spilling port part of the drain pan and then slowly pull out the foaming parts firstly. * As there is remained water in the drain pan, clear it carefully. <p>2. Attachment</p> <ol style="list-style-type: none"> Arrange direction of the drain pan directly to the foaming parts and insert it. * Pass the fan motor lead wire through the inner side of the drain pan. Attach the fixing screws of the drain pan fixing implement which was taken off in item 1-6). ($\varnothing 4 \times 12$, 4 pcs.) Insert the drain plug. (Put the tool with thin top in the hole of the drain plug, and then push the plug in.) Perform wiring works to original arrangement, wiring of the fan motor, louver motor lead wires, and the room temperature (TA) sensor, and then attach the wiring fixing bracket and the wiring cover. Following to works in items ④-2 and ②-2, attach the panel, electric parts cover as original. 	    

No.	Part name	Procedure	Remarks
⑧	Drain pump	<p>1. Detachment</p> <ol style="list-style-type: none"> 1) Remove the drain pan. (Refer to ⑦-1.) 2) Remove the drain pump connector (CN504: 2P, White) connected to the control P.C. board and remove the lead wires from the clamp. 3) Remove the fixing screws to remove the drain pump. (Ø4 × 10, 3 pcs.) 4) Move the knob of the hose band which fixes the drain hose a little from pump connecting part to the hose side, and then remove the drain hose from the drain pump. * Be careful that water may be out. <p>2. Attachment</p> <ol style="list-style-type: none"> 1) Confirm the direction of the drain pump, and then fix it with screws. (Ø4 × 10, 3 pcs.) 2) Connect the drain hose to the drain pump. * For the drain hose, insert up to the root of the connecting part. * Attach a band to the marked position of the hose, and the knob of a hose band is attached to the deep side of a set. 3) Pass the drain pump wiring through side plate and clamp, and then connect the connector to the control P.C. board. 4) Following to work in ⑦-2, attach the drain pan, panel, and electrical parts covers as original. 	  <p>Drain pump Hose band Drain hose</p> <p>Fixing screw</p>
⑨	Float switch	<p>1. Detachment</p> <ol style="list-style-type: none"> 1) Remove the drain pan. (Refer to ⑦-1.) 2) Remove the float switch connector (CN34 3P, Red) connected to the control P.C. board, and then take off the lead wires from the clamp. 3) Remove the screws which fix the float switch. (Ø4 × 8, 1 pc.) 4) Slide the float switch fixed bracket as direction shown in the right figure, and then take off it from the claw. <p>2. Attachment</p> <ol style="list-style-type: none"> 1) Insert the float switch fixing plate into the claw, and tighten the fixing screw. 2) Pass the float switch lead wires through the side plate and the clamp, and then connect the connector to the control P.C. board. 3) Following to work in ⑦-2, attach the covers of the drain pan, panel, and electric parts box as original. 	 <p>Lock release direction Fixing screw Claw Float switch Float switch fixing plate</p>

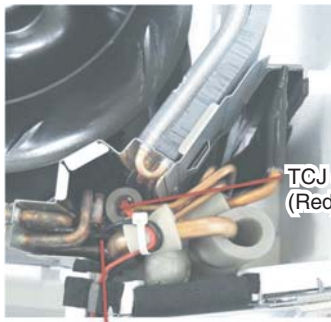
No.	Part name	Procedure	Remarks
⑩	Fan motor	<p>1. Detachment</p> <ol style="list-style-type: none"> 1) Remove the turbo fan, electric parts cover, wiring cover and wiring fixing plate. (Refer to ⑥-1, ②-1, ⑦-1-2, ⑦-1-3.) 2) Remove the fan motor connector (CN210, White, 7P) connected to the control P.C. board, and then take off the lead wires from the clamp. 3) Remove the shoulder screws (Black, 2pcs.) of the motor lead wiring cover, and separate the lead wires and the lead wire cover. 4) Remove the hexagon nuts (M6) which fix the motor, and the washers. (3 pcs. Each). * When taking off them, hold them with a hand so that motor will not fall down. 5) Remove the motor with rubber cushion from the bolt. <p>2. Attachment</p> <ol style="list-style-type: none"> 1) Pass rubber cushion of the motor in the bolt, put the washer and the hexagon nut in this order, and then tighten to fix them. (Tightening torque: $4.9 \pm 0.5N \cdot m$) 2) Pass the lead wire through the motor lead wire fixing plate removed in 1-3), and then fix it with shoulder screw. 3) Perform wiring of the motor lead wires as original, connect the connector to the control P.C. board, and then attach the wiring fixing plate and the wiring cover. 4) Following to works in ⑥-2 and ②-2, attach the turbo fan and the electric parts covers. 	 <p>Shoulder screws (Black)</p> <p>Motor lead wire cover</p>   <p>Bolt</p> <p>Hexagon nut</p> <p>Washer</p> <p>Rubber cushion</p>
⑪	TC TCJ Sensor	<p>1. Detachment</p> <ol style="list-style-type: none"> 1) Remove the drain pan. (Refer to ⑦-1.) 2) Pull out the sensor to be exchanged from the sensor holder. 3) Remove the connector connected to the control P.C. board, and take off wires from the clamp. (Refer to ⑤.) <p>2. Attachment</p> <ol style="list-style-type: none"> 1) Insert the sensor to be exchanged into the specified sensor. (Refer to the right figure.) 2) Perform wiring of the sensor as original. 	 <p>TCJ sensor (Red)</p> <p>TC sensor (Black)</p>

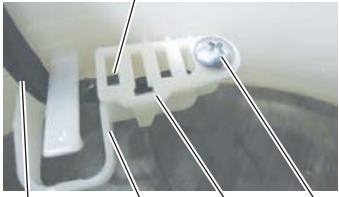
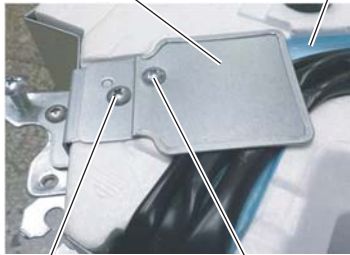
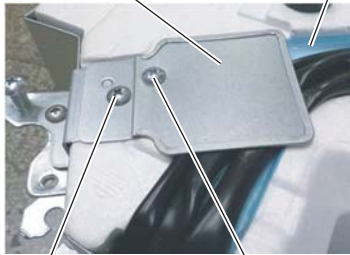
No.	Part name	Procedure	Remarks
⑫	TA sensor	<p>1. Detachment</p> <ol style="list-style-type: none"> 1) Remove the panel, electric parts box cover, wiring cover and wiring fixing plate. (Refer to ④-1, ②-1, ⑦-1-2, ⑦-1-3.) 2) Disconnect TA sensor connector (CN104 Yellow, 2P) which is connected to the control P.C. board, and take off the lead wire from the clamp. 3) Remove the screw of the TA sensor cover. (Ø4 × 10, 1pc.) 4) Remove TA sensor from the TA sensor fixed implement. <p>2. Attachment</p> <ol style="list-style-type: none"> 1) Fix TA sensor to TA sensor fixing implement, and fix the TA sensor cover with screw. (Ø4 × 10, 1 pcs, Ø4 × 8, 1 pcs.) 2) Perform wiring of TA sensor as original. 	<p>Adjust position of the tube so that the tube of TA sensor will be included in the cover.</p>  <p>TA sensor fixing bracket Fixing screw TA sensor TA sensor cover</p>  <p>Wiring fixing plate Groove for wiring of the drain pan</p>  <p>Fixing screw (Ø4 × 8) Fixing screw (Ø4 × 10)</p>

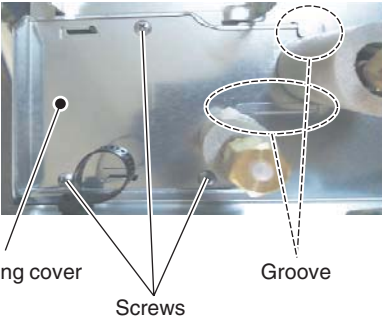
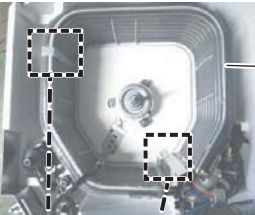
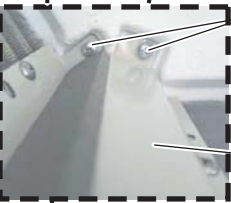
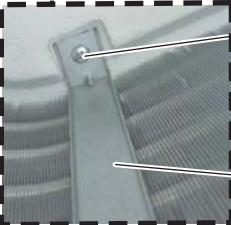
No.	Part name	Procedure	Remarks
⑬	Heat exchanger	<p>1. Detachment</p> <ol style="list-style-type: none"> 1) Recover refrigerant gas. 2) Remove the refrigerant pipe at indoor unit side. 3) Remove the drain pan. (Refer ⑦-1.) 4) Disconnect the heat exchanger sensor (TC1, TC2, TCJ), PMV lead wires connectors from the control P.C. board, and then remove their lead wires from the clamp. (Refer to ⑤-1.) 5) Remove the fixing screws of the piping cover and take off the piping cover. (Ø4 × 8, 3 pcs.) 6) Remove the shoulder screws of the separate plate (2 positions) and fixing plate (1 position), and then remove the heat exchanger. (3 shoulder screws) <p>NOTE</p> <hr/> <p>* Supporting with a hand, remove the heat exchanger so that it will not be fallen down.</p> <p>* Take note that you will not get hurt by touching to Aluminum fin. Be sure to put on the protective gloves and the safety working clothing.</p> <hr/> <p>2. Attachment</p> <ol style="list-style-type: none"> 1) Attach the heat exchanger as original with the separate plate and the fixing plate. 2) Slide the piping cover to the groove, fix it to the side plate, and then use the screws. (Ø4 × 8, 3 pcs.) 3) Perform wiring of the sensor and PMV lead wires as original. 4) Connect the refrigerant pipe as before and then apply vacuuming. 5) Following to the work in ⑦-2, attach the parts as original. 	<p>Remarks</p>    
<p>NOTE</p> <hr/> <p>After assembling, check if that there is no abnormal sound, vibration, or puncture. Check the exchange point when you have a problem.</p> <hr/>			

12. EXPLODED VIEWS AND PARTS LIST

12-1. RAV-RM301MUT-E, RM401MUT-E, RM561MUT-E

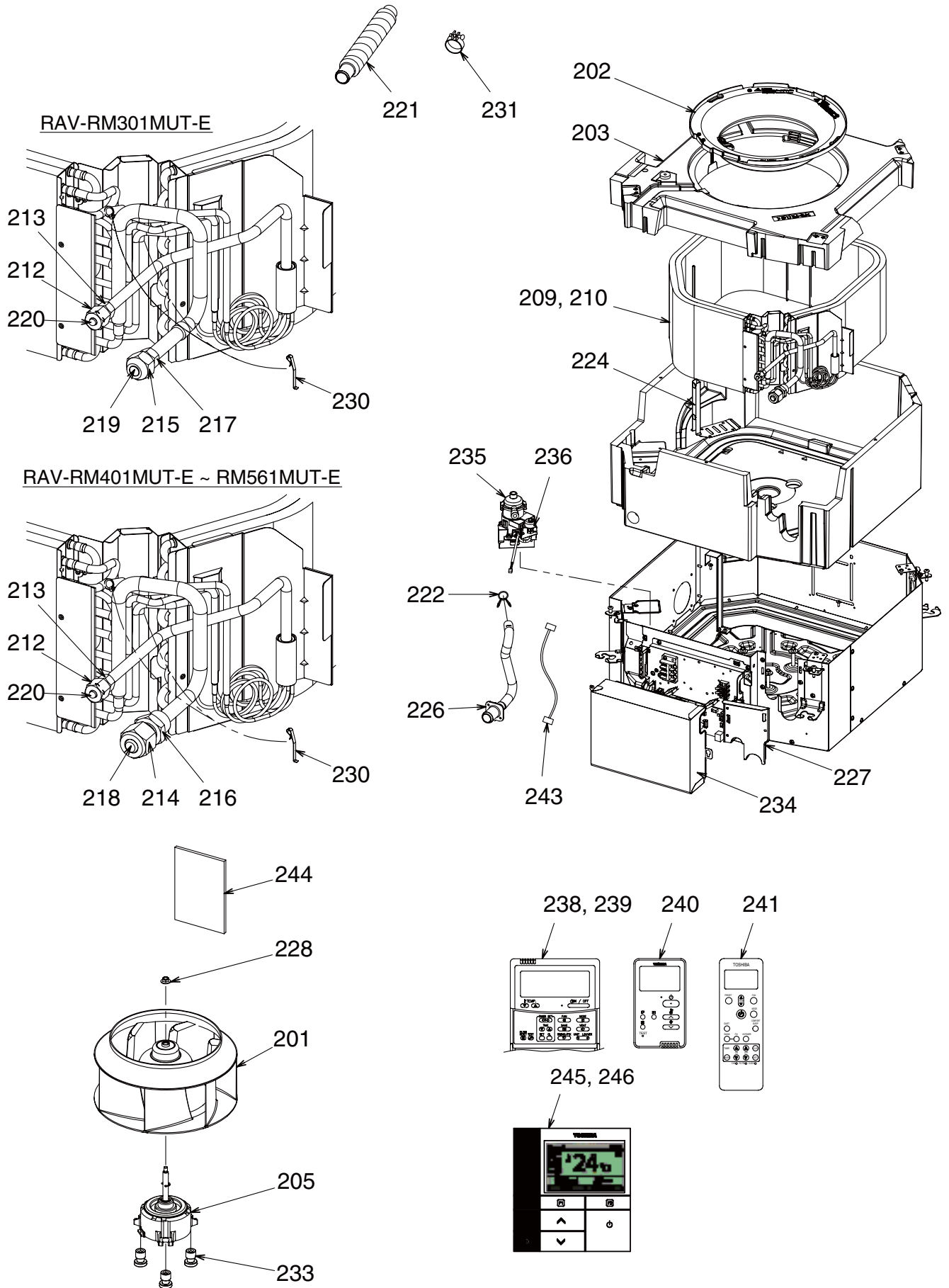

Location No.	Part No.	Description	Q'ty/Set RAV-RM		
			301MUT-E	401MUT-E	561MUT-E
201	43120277	FAN, ASSY TURBO	1	1	1
202	43122165	BELL MOUTH	1	1	1
203	43172259	PAN ASSY, DRAIN	1	1	1
205	4312C161	MOTOR, FAN, ICF-340D60-1(N)	1	1	1
209	4314J573	REFRIGERATION CYCLE ASSY		1	1
210	4314J574	REFRIGERATION CYCLE ASSY	1		
212	43149499	NUT,FLARE,1/4,IN	1	1	1
213	43149497	SOCKET,1/4,IN	1	1	1
214	43149501	NUT,FLARE,1/2,IN		1	1
215	43149500	NUT,FLARE,3/8,IN	1		
216	43149494	SOCKET,1/2,IN		1	1
217	43149498	SOCKET,3/8,IN	1		
218	43047692	BONNET,1/2,IN		1	1
219	43F47609	BONNET,3/8,IN	1		
220	43F49697	BONNET,1/4,IN	1	1	1
221	43170276	HOSE, DRAIN	1	1	1
222	43079249	BAND, HOSE	1	1	1
224	43163052	HOLDER, LEAD, FAN MOTOR	1	1	1
226	43170277	HOSE, DRAIN	1	1	1
227	43119542	COVER, PIPE	1	1	1
228	43F97212	NUT	1	1	1
230	43F19904	HOLDER, SENSOR (TS)	2	2	2
231	43179170	BAND, HOSE	2	2	2
233	43139187	RUBBER, CUSHION	3	3	3
234	43162087	COVER, E-BOX	1	1	1
235	43177021	PUMP, DRAIN	1	1	1
236	43151323	SWITCH, FLOAT	1	1	1
238	43166011	REMOTE CONTROLLER, SX-A4EE	1	1	1
239	43166012	REMOTE CONTROLLER, SX-A5EE	1	1	1
240	43166022	REMOTE CONTROLLER, SX-U01EE	1	1	1
241	43166018	REMOTE CONTROLLER, WIRELESS, WH-L11SE	1	1	1
243	43160663	LEAD, RELAY	1	1	1
244	431S8341	OWNERS MANUAL	1	1	1
245	43166036	REMOTE CONTROLLER, SX-P01BE	1	1	1
246	43166037	REMOTE CONTROLLER, SX-P02BE	1	1	1

12-2. RAV-RM301MUT-TR, RM401MUT-TR, RM561MUT-TR

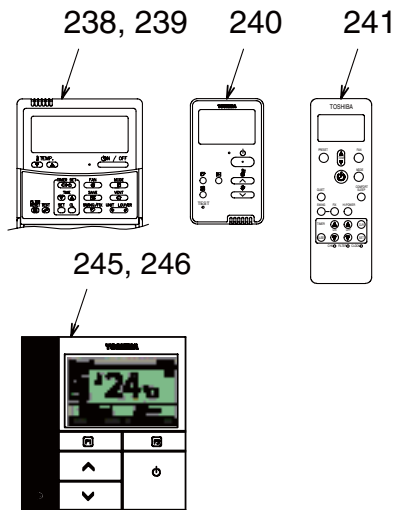
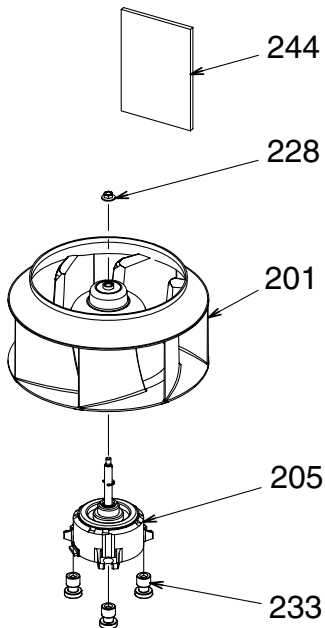
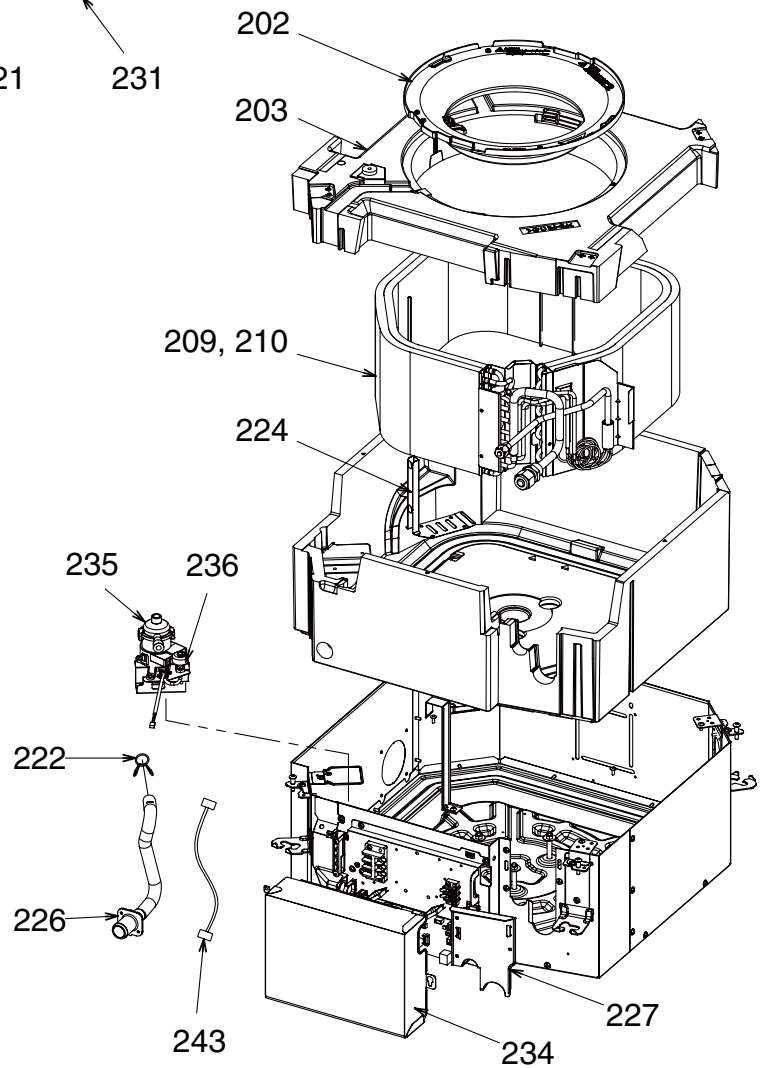
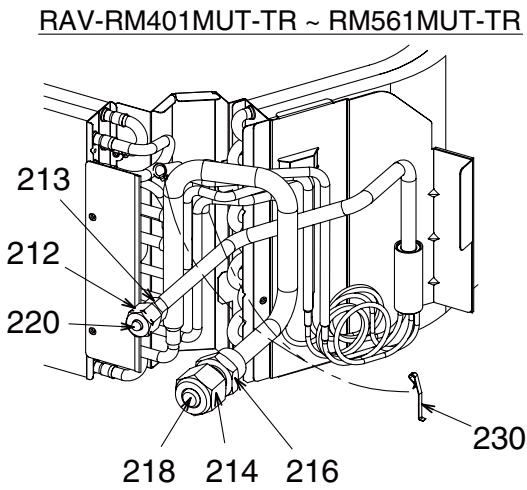
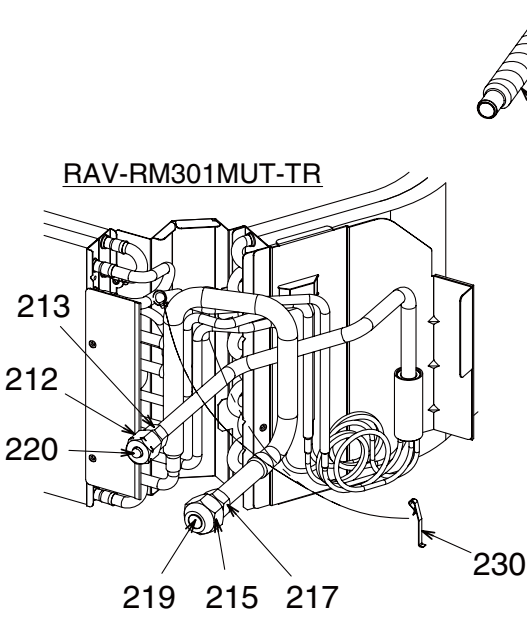

Location No.	Part No.	Description	Q'ty/Set RAV-RM		
			301MUT-TR	401MUT-TR	561MUT-TR
201	43120277	FAN, ASSY TURBO	1	1	1
202	43122165	BELL MOUTH	1	1	1
203	43172259	PAN ASSY, DRAIN	1	1	1
205	4312C161	MOTOR, FAN, ICF-340D60-1(N)	1	1	1
209	4314J573	REFRIGERATION CYCLE ASSY		1	1
210	4314J574	REFRIGERATION CYCLE ASSY	1		
212	43149499	NUT,FLARE,1/4,IN	1	1	1
213	43149497	SOCKET,1/4,IN	1	1	1
214	43149501	NUT,FLARE,1/2,IN		1	1
215	43149500	NUT,FLARE,3/8,IN	1		
216	43149494	SOCKET,1/2,IN		1	1
217	43149498	SOCKET,3/8,IN	1		
218	43047692	BONNET,1/2,IN		1	1
219	43F47609	BONNET,3/8,IN	1		
220	43F49697	BONNET,1/4,IN	1	1	1
221	43170276	HOSE, DRAIN	1	1	1
222	43079249	BAND, HOSE	1	1	1
224	43163052	HOLDER, LEAD, FAN MOTOR	1	1	1
226	43170277	HOSE, DRAIN	1	1	1
227	43119542	COVER, PIPE	1	1	1
228	43F97212	NUT	1	1	1
230	43F19904	HOLDER, SENSOR (TS)	2	2	2
231	43179170	BAND, HOSE	2	2	2
233	43139187	RUBBER, CUSHION	3	3	3
234	43162087	COVER, E-BOX	1	1	1
235	43177021	PUMP, DRAIN	1	1	1
236	43151323	SWITCH, FLOAT	1	1	1
238	43166011	REMOTE CONTROLLER, SX-A4EE	1	1	1
239	43166012	REMOTE CONTROLLER, SX-A5EE	1	1	1
240	43166022	REMOTE CONTROLLER, SX-U01EE	1	1	1
241	43166018	REMOTE CONTROLLER, WIRELESS, WH-L11SE	1	1	1
243	43160663	LEAD, RELAY	1	1	1
244	431S8344	OWNERS MANUAL	1	1	1
245	43166036	REMOTE CONTROLLER, SX-P01BE	1	1	1
246	43166037	REMOTE CONTROLLER, SX-P02BE	1	1	1

E-Parts

RAV-RM301MUT-E, RM401MUT-E, RM561MUT-E
 RAV-RM301MUT-TR, RM401MUT-TR, RM561MUT-TR

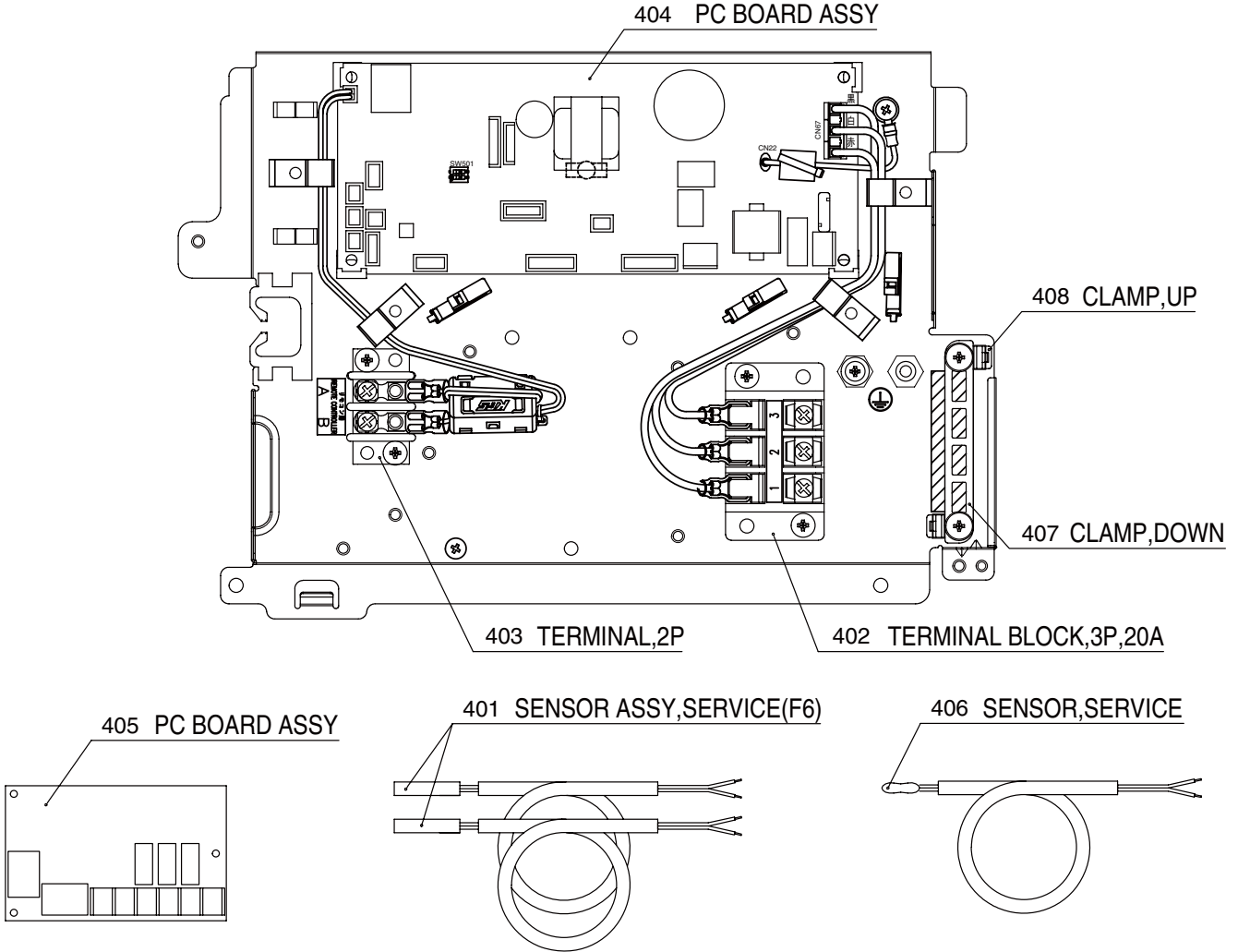

Location No.	Part No.	Description	Q'ty/Set RAV-RM		
			301MUT-E	401MUT-E	561MUT-E
			301MUT-TR	401MUT-TR	561MUT-TR
401	43050425	SENSOR ASSY, SERVICE, TC(F6)	2	2	2
402	43160565	TERMINAL BLOCK, 3P, 20A	1	1	1
403	43160568	TERMINAL, 2P	1	1	1
404	4316V656	PC BOARD ASSY, MCC-1643	1	1	1
405	43459017	PC BOARD ASSY, TCB-PCUC1E	1	1	1
406	43F50426	SENSOR, SERVICE, TA	1	1	1
407	43163057	CLAMP, DOWN	1	1	1
408	43163058	CLAMP, UP	1	1	1

◆ Ceiling panel

RBC-UM21PG (W)-E

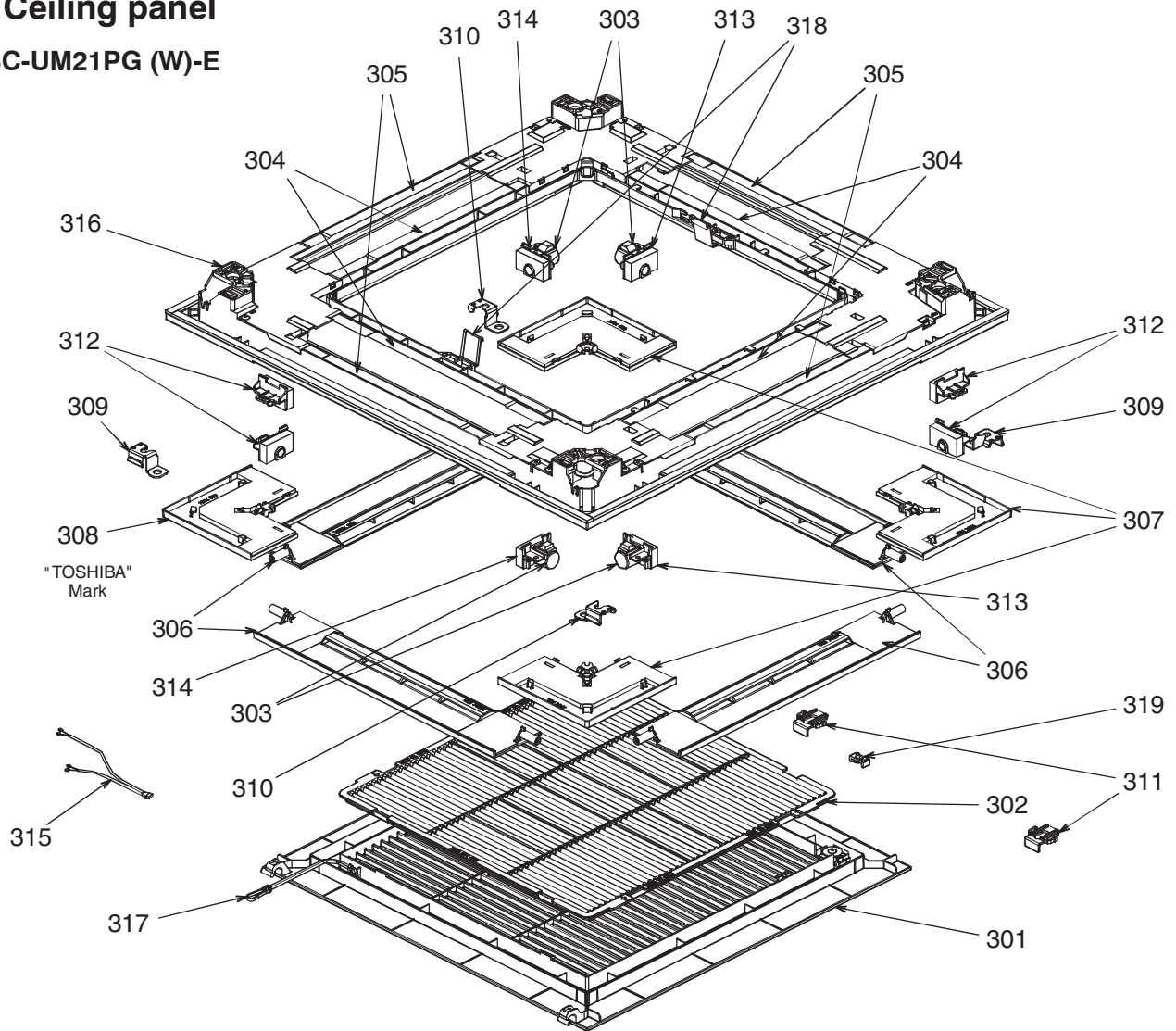

Location No.	Part No.	Description	Q'ty/Set RBC-UM21PG(W)-E
301	43109441	GRILLE, AIR INLET	1
302	43180361	AIR FILTER	1
303	4342D001	MOTOR, LOUVER, MSBPC20F04	4
304	43107296	OUTLET, AIR FORM	4
305	43107297	OUTLET, AIR FORM	4
306	43122166	LOUVER ASSY	4
307	4310A142	COVER, PANEL ASSY	3
308	4310A143	COVER, PANEL ASSY	1
309	43107298	PLATE, FIX PANEL (A)	2
310	43107299	PLATE, FIX PANEL (B)	2
311	43107300	HOOK	2
312	43107301	CAP, AXIS	4
313	43107302	FIX, MOTOR ASSY	2
314	43107303	FIX, MOTOR ASSY	2
315	43160664	LEAD, MOTOR	1
316	4310A144	PANEL, HINS ASSY	1
317	43419022	STRING	1
318	43107304	HANGER	2
319	43107305	FIX, GRILLE	1

◆ Wireless remote controller kit

RBC-AX32UM (W)-E

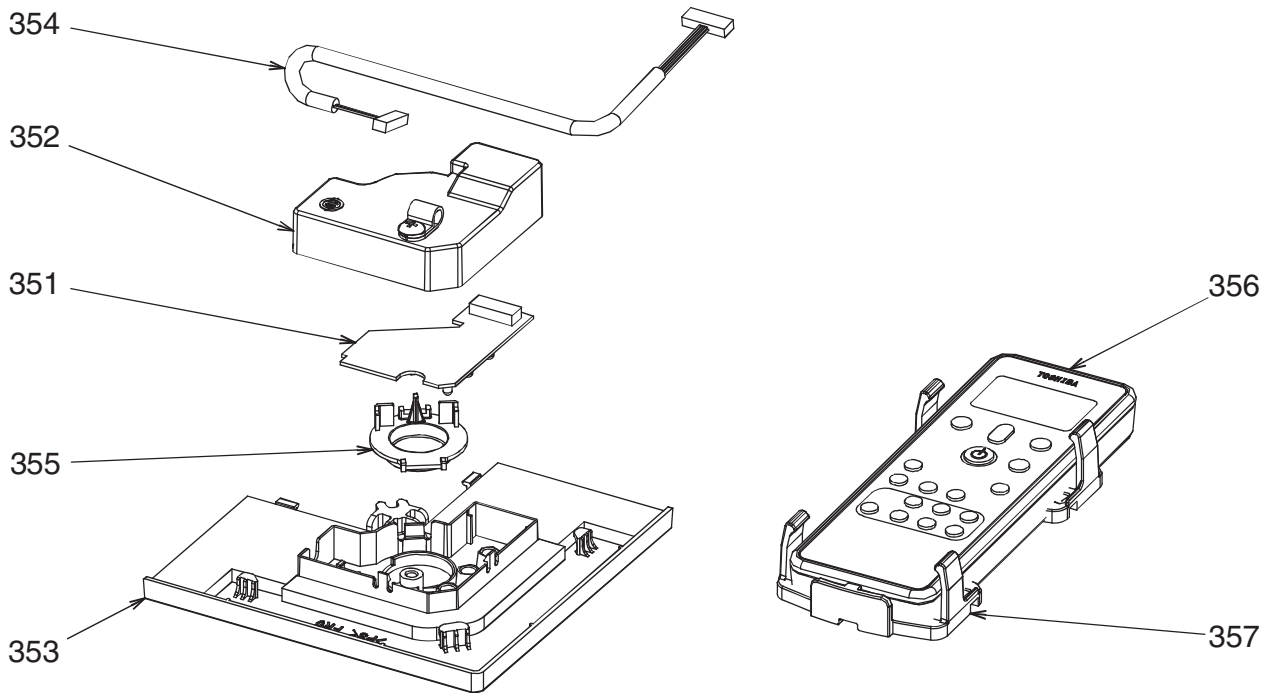

Location No.	Part No.	Description	Q'ty/Set RBC-AX32UM(W)-E
351	4316V616	PC BOARD ASSY, REMOTE RECIEVER	1
352	43162088	COVER, WRS	1
353	43108036	COVER, PANEL WRS	1
354	43160665	LEAD	1
355	43408061	COVER, WIRELESS	1
356	43166018	REMOTE CONTROLLER, WIRELESS, WH-L11SE	1
357	43F83071	HOLDER, REMOTE, CONTROLLER	1

◆ Occupancy sensor

TCB-SIR41UM-E

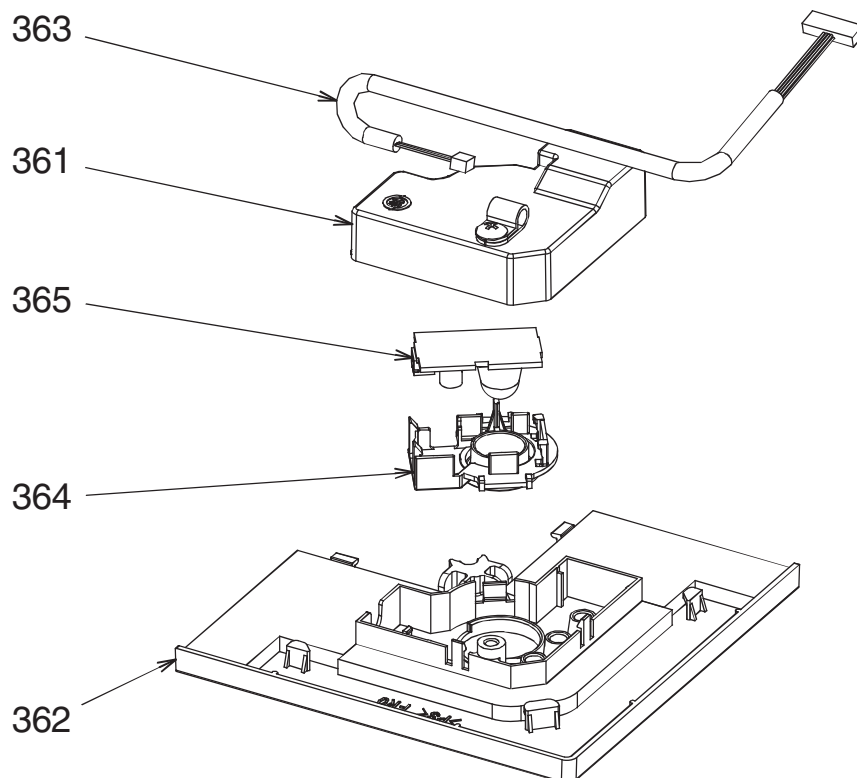

Location No.	Part No.	Description	Q'ty/Set TCB-SIR41UM-E
361	43162088	COVER, WRS	1
362	43108037	COVER, PANEL WRS	1
363	43160666	LEAD	1
364	43408062	COVER, SENSOR	1
365	43469067	THERMOSTAT	1

TOSHIBA CARRIER CORPORATION

72-34 Horikawa-cho, Saiwai-ku, Kawasaki-shi, Kanagawa 212-8585, JAPAN

Copyright © 2018 TOSHIBA CARRIER CORPORATION, ALL Rights Reserved.