



*Pocket Quick
Reference Guide
On the **TOSHIBA***

R410A – Heat Recovery VRF System



This guide shows the differences between the new SHRMe range of units and earlier editions.

The range covers.

- 1) – SHRMe Three pipe heat recovery three phase, (Simultaneous Heating / Cooling), from 25kW to 135kW standard efficiency.
- 2) - SHRMe Three pipe heat recovery three phase, (Simultaneous Heating / Cooling), from 50kW to 90kW high efficiency.

The information within this pocket guide is applicable to all variants.



Pre-commissioning. Electrical

- 1) Confirm that the power supply at each outdoor unit is correct, three phase and neutral 380 – 400 volts 50 Hz AC, SHRMe (Fig 1).

Fuse sizes are dependent on unit size and current electrical regulations, (IET 17th edition).

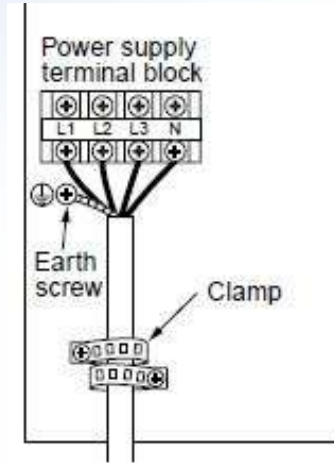

Fig 1

On modularised systems, all the outdoor units must be of the same generation MAP##6FT8-E. And are electrically joined together via a 1.5mm two core screened

RBM-
screened

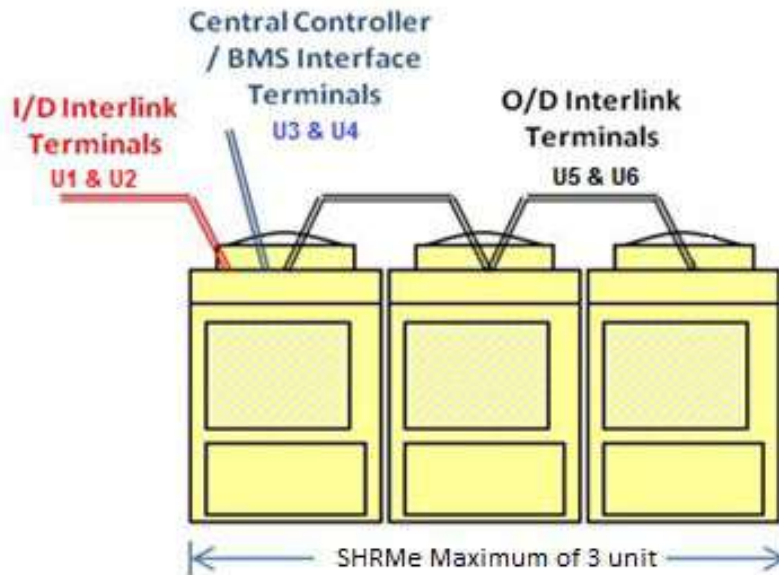

Fig 2

Cool Designs Ltd

Raising the Standards in Air Conditioning Distribution



2) Indoor to outdoor connection, 1.5mm two core screened cable connected to terminals U1 & U2 of the LEAD outdoor unit and “daisy chained around ALL relevant indoor units, (Fig 3), *(To speed up commissioning, leave these terminals disconnected at the outdoor unit until all other works are complete. By these cores being disconnected premature addressing cannot be carried out, but the crankcase heaters can be operated, more on this later.)*

3) Central / BMS connections, 1.5mm two core screened cable connected to terminals U3 & U4 at each LEAD outdoor unit. (Fig 3)

Make sure that the “Plug and Socket” connection between terminals

U1, U2 & U3, U4 is Disconnected, (Factory default DISCONNECTED) (Fig 4)

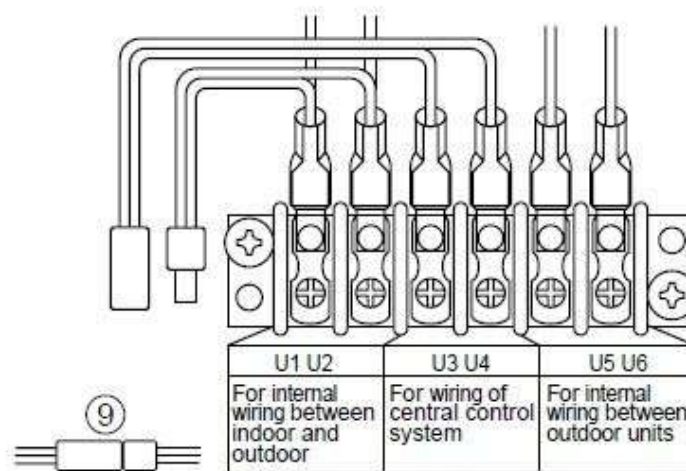

Fig 4



Cool Designs Ltd

Raising the Standards in Air Conditioning Distribution

Refrigeration.

Prior to carrying out any pressure testing or evacuation, make sure that the Liquid, Discharge Suction and oil balance valves are **FULLY CLOSED**.

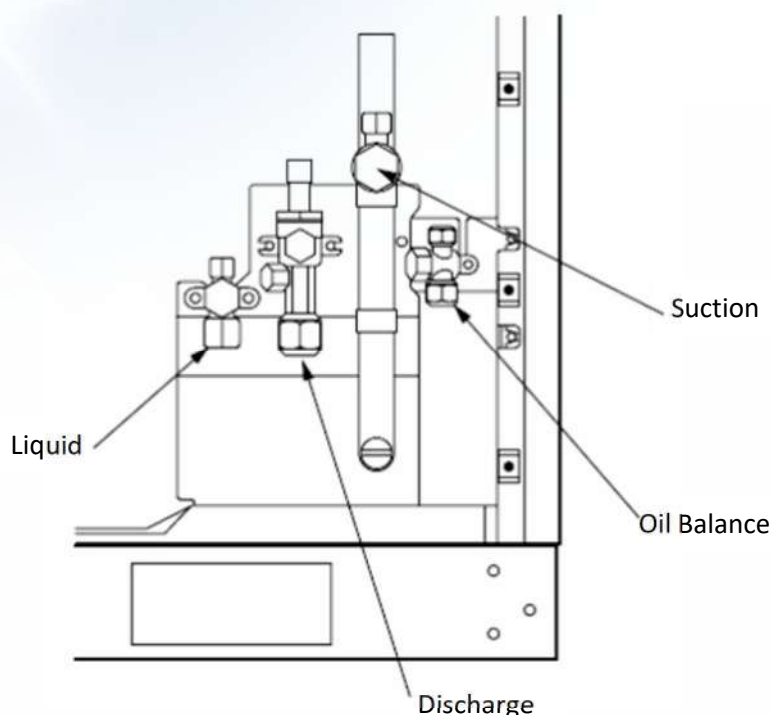

Fig 5

Confirm that the oil balance line has been suitable insulated, for full details please refer to the Toshiba VRF Installation manual which accompanied the equipment.

- 1) Connect a suitable R410A refrigerant manifold to ALL service valves, Liquid, Discharge, Suction and Oil balance.
- 2) Carry out a complete pressure test using suitable oxygen free nitrogen, across ALL lines in accordance with current F-Gas regulations and "IOR Good Refrigeration Practices" Manufacturers minimum strength test to be 550 psig / 38 Bar, duration dependant on pipe lengths, minimum requirement 15 minutes, recommended duration minimum 1 hour, reduce the pressure to between 450psig/31 Bar and 500 psig/35 Bar and hold "Leak Test" for a minimum duration of 1 hour, manufacturers recommendation would be for a 24 hour period.

However, if there is a difference between the ambient temp, when pressure has been applied and when 24 hours has passed, pressure changes by approx. 0.01MPa (0.1kg/cm²G) per 1°C. Correct the pressure.

Cool Designs Ltd

Raising the Standards in Air Conditioning Distribution



- 3) Close off manifold gauge valves and disconnect the Oxygen Free Nitrogen cylinder.
- 4) Replace Oxygen free nitrogen cylinder with a suitably sized vacuum pump, (6cfm or better)
- 5) Connect suitable vacuum gauge.
- 6) Evacuate the system to the best vacuum weather conditions will allow, ideally between 2 Torr (2.7 mb) to 4 Torr (5.5 mb). duration 2 – 3 hours.
- 7) Once a vacuum is achieved, close the valve at the vacuum pump and turn off the vacuum pumps power supply, leave the vacuum gauge connected. Leave the system to stand for 1 hour, check vacuum gauge if there is no loss move on, if there is a pressure loss, identify the potential cause rectify and repeat.
- 8) Replace the vacuum pump with suitable virgin R410A refrigerant cylinder.
- 9) Charge the system with the calculated quantity of R410A refrigerant.

How to calculate the refrigerant charge required.

- 1) Measure the liquid lines of the installation, (Do not include bends.)
- 2) Identify the size of liquid line. (1/4", 3/8", 1/2", 5/8", 3/4" or 7/8")
- 3) Multiply the relevant lengths by the factors shown in the table T1 below.

Liquid Line Size	Liquid Line Length metres	X	Factor Three Pipe kg/m	=	Result
1/4"		X	0.0325	=	
3/8"		X	0.0715	=	
1/2"		X	0.1365	=	
5/8"		X	0.2080	=	
3/4"		X	0.3250	=	
7/8"		X	0.4550	=	
			Sub Total		
Add Correction (Trim) from the following tables			Trim Charge		
			TOTAL		

T1



Trim Charge Charts.

Trim Charge SHRMe (Standard)								
HP	1	2	Trim	HP	1	2	3	Trim
8	8		2	22	12	10		6
10	10		3	24	14	10		8
12	12		8	26	14	12		12
14	14		10	28	14	14		12
16	16		12	30	16	14		14
18	18		14	32	18	14		15
20	20		15	34	18	16		16
				36	18	18		18
				38	20	18		22
				40	20	20		24
				42	14	14	14	14

Fig 6

Trim Charge SHRMe (High Efficiency)				
HP	1	2	3	Trim
16	8	8		1
18	10	8		3
20	10	10		4
24	8	8	8	-3
26	10	8	8	1
28	10	10	8	1
30	10	10	10	3
36	12	12	12	7
42	16	16	10	14

Fig 7

Refrigeration.

Keeping the valves of the outdoor unit closed, charge the liquid refrigerant, (By Weight) into the service port of the liquid line valve.

If the required amount of refrigerant cannot be charged into the liquid line with the valves closed, fully open the liquid and suction valves at the outdoor unit, (**Keep the discharge –valve CLOSED**) operate the air conditioner in the **COOLING** mode¹, part seat (Partially close), the suction gas valve and then charge liquid refrigerant into the suction line service port.

Whilst inserting refrigerant in this method, “choke” the refrigerant slightly by operating the valve of the refrigerant cylinder or charging manifold to maintain a liquid refrigerant flow, always charge refrigerant gradually.

NOTE: In order to run the system in COOLING mode, the system would need to be “Addressed”

Cool Designs Ltd

Raising the Standards in Air Conditioning Distribution



Addressing the system.

Prior to addressing the system for the first time carry out the following;

- 1) Turn ON the power to the indoor units
- 2) Turn ON the power to the outdoor unit/s, (making sure that electrical terminals U1 & U2 are connected to the indoor units), starting with the last in the line and finishing with the first, the “lead” unit
- 3) The lead outdoor unit is the unit located nearest to the indoor units and is electrically connected to the indoor units via U1 & U2 terminals.
- 4) Confirm that the “White Link Plug & Socket” connected between U1 & U3 / U2 & U4 on the “Lead” outdoor unit is **DISCONNECTED**. Refer to Fig 4
- 5) When setting up multiple systems for connection to a central remote controller or BMS system, confirm that the “Systems” are unequally addressed. Factory system setting is number 1. System addressing is carried out on the “Lead” unit of each system via dip switches SW13 bits 1 to 4 and SW14 bits 1 to 4. (Fig 8 & Fig 9).

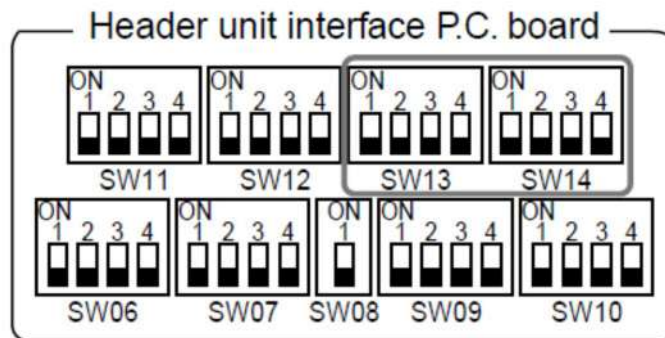

Fig 8

Line address switch on outdoor interface P.C. board

(○: Switch ON, ×: Switch OFF)

Line address	SW13				SW14			
	1	2	3	4	1	2	3	4
1				×	×	×	×	×
2				×	○	×	×	×
3				×	×	○	×	×
4				×	○	○	×	×
5				×	×	×	○	×
6				×	○	×	○	×
7				×	×	○	○	×
8				×	○	○	○	×
9				×	×	×	×	○
10				×	○	×	×	○
11				×	×	○	×	○
12				×	○	○	×	○
13				×	×	×	○	○
14				×	○	×	○	○

Line address	SW13				SW14			
	1	2	3	4	1	2	3	4
15				×	×	○	○	○
16				×	○	○	○	○
17				○	×	×	×	×
18				○	○	×	×	×
19				○	×	○	×	×
20				○	○	○	×	×
21				○	×	×	○	×
22				○	○	×	○	×
23				○	×	○	○	×
24				○	○	○	○	×
25				○	×	×	×	○
26				○	○	×	×	○
27				○	×	○	×	○
28				○	○	○	×	○

Fig 9



- 6) Confirm that the “End of line resistor” SW30 bit 2 is in the “ON” position on each unit.

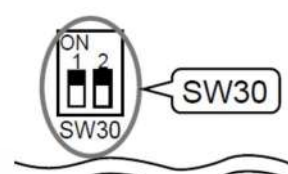

- 7) Check the LED display of the “Lead” unit the display should read U1 LO8; the display will be “flashing”

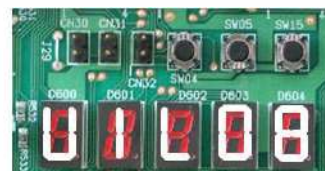

- 8) Press and “Briefly Hold” SW15. The display will clear and the display will automatically scroll from “Auto 1→Auto 2→Auto 9”
(Max. 10 minutes for 1 line (Usually, approx. 5 minutes))

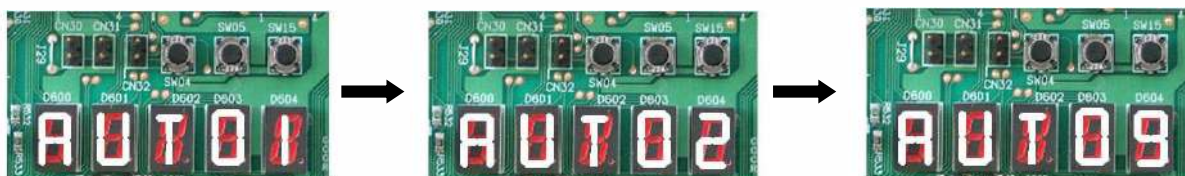
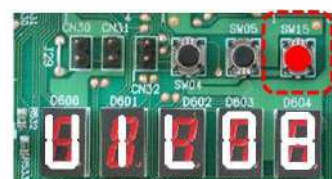

- 9) On completion the display will briefly clear and be replaced with a U1 - - - .



Addressing is complete.

Cool Designs Ltd

Raising the Standards in Air Conditioning Distribution



10) Set data retrieval switches, SW01, to **1**, SW02 to **4** & SW03 to **3** to check the quantity of indoor units the system has addressed. Compare this against what has been installed, both figures should be the same, if the systems quantity is lower than the quantity installed, check that all indoor units have power applied and that there is a good electrical connection on U1 + U2.

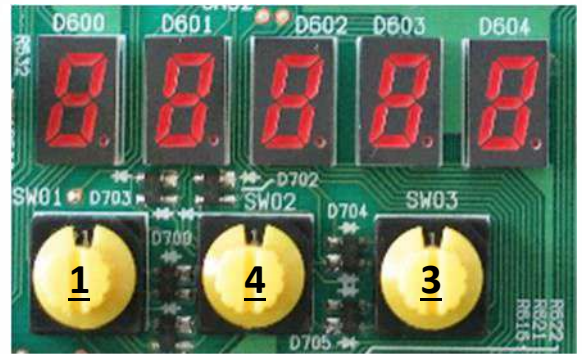

11) If the systems quantity was lower than the actual and a problem with the power or the communication was identified and corrected, then an "ADD" unit function can be used.

12) Set data retrieval switches, SW01 to **2**, SW02 to **14** and SW03 to **2**, display should read "In At", push and hold SW04 for 5 seconds. The display will auto scroll through the "Auto 1→Auto 2→Auto 9", when display returns to "U1 - -" setup operation is complete.

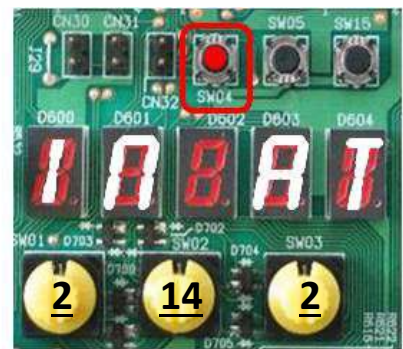

13) Repeat step 10 above.

14) Power down the indoor/outdoor units. Return the rotary switches to 1 – 1 – 1



15) If a central controller or BMS system is to be used, Connect the "relay connector" on terminals U3 & U4 at the lead outdoor unit, refer to fig 4 above.

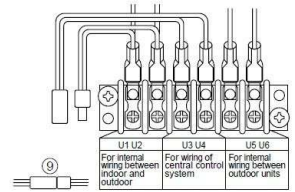

16) Set SW30 bit two to the off position on all outdoor lead units, excluding system 1 (Or the system with the lowest number).

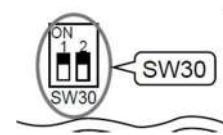

17) Turn power on indoor unit's first, outdoor units second.

18) Run the system in **TEST COOLING** mode, set SW01 to **2**, SW02 to **5** and SW03 to **1**, push and hold SW04 for 2 seconds. All connected indoor units will now operate in the cooling mode.

(Note: The units will operate in a restricted / limited mode, NOT full load)

LED display will read "C -C", allow the system to run for 15 / 30 minutes.

Return SW01 to **1**, SW02 to **1** and SW03 to **1** to return to normal operation.

19) Run the system in **TEST HEATING** mode, set SW01 to **2**, SW02 to **6** and SW03 to **1**, push and hold SW04 for 2 seconds. All connected indoor units will now operate in the heating mode.

(Note: The units will operate in a restricted / limited mode, NOT full load)

LED display will read "H -H", allow the system to run for 15 / 30 minutes.

Return SW01 to **1**, SW02 to **1** and SW03 to **1** to return to normal operation.

Cool Designs Ltd

Raising the Standards in Air Conditioning Distribution



Useful common data from outdoor unit.

SW01	SW02	SW03	Description	7 Segment Display				
				A		B		
1	1	1	Fault codes	U	#	-	-	-
1	1	2	Discharge pressure (Mpa) (1 Mpa =10 Bar)	P	d	-	-	-
1	2	2	Suction pressure (Mpa) (1 Mpa =10 Bar)	P	s	-	-	-
1	3	2	Liquid line pressure (Mpa) (1 Mpa =10 Bar)	P	L	-	-	-
1	2	3	System capacity (HP)	#	#	-	H	P
1	2	16	Latest error code of follower unit No. 2 (Outdoor)	E	2	-	-	-
1	3	3	Number of outdoor units	-	#	-	-	P
1	3	16	Latest error code of follower unit No. 3 (Outdoor)	E	3	-	-	-
1	4	1	Outdoor unit size in HP	#	#	-	H	P
1	4	3	Number of indoor units + how many operating in cooling mode	#	#	C	#	#
1	5	3	Number of indoor units + how many operating in heating mode	#	#	H	#	#
2	1	1	Circuit test – Cooling	C	-	-	-	-
2	2	1	Circuit test – Heating	H	-	-	-	-
2	1	2	Clearing system address	A	d	b	u	S
2	2	2	Clearing central addresses	A	d	n	E	t
2	4	1	Remote controller identification function	A	1	-	F	F
2	5	1	System test – cooling, when underway press SW04 to scroll through, Suction pressure & temperature, discharge pressure & temperature, sub-cooled liquid temperature.	C	-	-	-	C
2	6	1	System test – heating, when underway press SW04 to scroll through, Suction pressure & temperature, discharge pressure & temperature, sub-cooled liquid temperature.	H	-	-	-	H
2	14	2	Adding additional indoor units	l	n	-	A	t
2	11	1	Pump down function	r	d	-	-	-

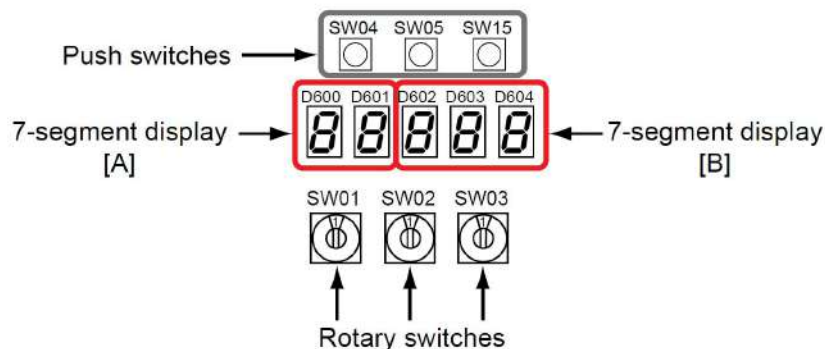

For a more detailed listing please refer to the Installation Manual of the Equipment installed or via the TOSHIBA Technical Handbook, available from our web site www.cdlweb.info



Common Questions

- Q1) When powering up the outdoor unit, the LED display shows “U – - - ”
- A1) Check interconnecting two core cables on U1 & U2.
- Q2) When powering up the outdoor unit, the LED display shows “U – E19”
- A2) Incorrect sequence of power application, correct sequence, indoor units first followed by outdoor units. Power down both indoor and outdoor sections, re-apply power in sequence indoor unit’s first, outdoor unit’s follower/s then lead unit second.
- Q3) Outdoor LED displays “U1E15”
- A3) No power to indoor units, check power supplies.
- Q4) Outdoor LED displays “U1E06”
- A4) Communication failure, check electrical continuity of U1 & U2 cable.
- Q5) Outdoor unit registers less Indoor units than installed (1-4-3 on lead outdoor PCB rotary switches)
- A5) Confirm that mains power is available to ALL indoor units, follow item 12 on previous page.

For full technical details please refer to the relevant manuals available for this product.

Cool Designs Ltd

Raising the Standards in Air Conditioning Distribution



SHRMe systems have 4 options available in respect to flow selector boxes.

The flow selector box on Toshiba heat recovery VRF systems are the devices which controls the mode of operation, allowing the indoor unit to change over from heating to cooling and visa versa.

There are 4 options available.

Option 1. - RBM-Y###3FE, (3 Series), Maximum pipe separation between flow selector box and individual indoor units = 15 metres, multiple indoor units maximum accumulated pipe length = 30m Power supply to flow selector box via indoor unit, interconnecting cables are provided with flow selector box, 6 metres in length, 15 m extension leads RBC-FSEX15 are available.

Up to a maximum of 8 indoor units, (code 0.8 each), can be “Connected” to one 3 series flow selector box the quantity of indoor units is dependent on the unit sizes selected.

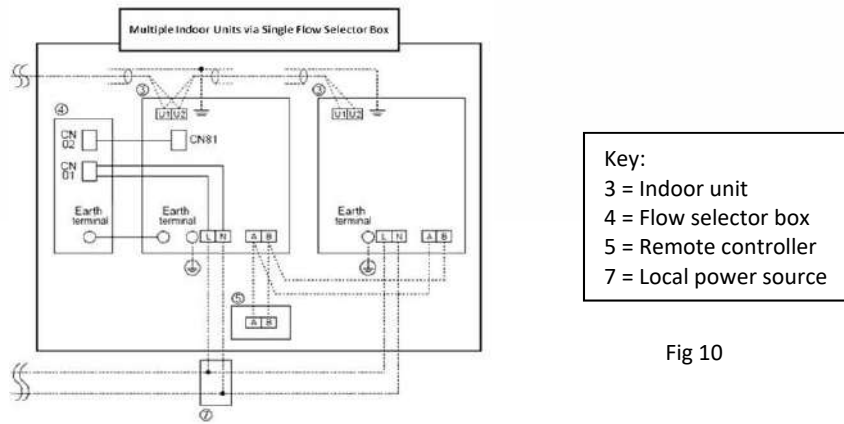

Fig 10

Each indoor unit’s needs its own fused power supply, (Suggested 6amp fuse) No independent power supply required for the 3 series flow selector box, power is obtained from the lead indoor unit, via supplied cables, power from L&N lead indoor unit to CN01 at flow selector box, communications via CN81 at lead indoor unit to CN02 at flow selector box.

Each indoor unit to be connected to the systems U1 & U2 “daisy chain”, no connection to flow selector box required.

All units “connected” to a single flow selector box must be “Group Controlled”, with a two core 0.5mm cable from remote controller using terminals A & B to lead indoor unit, “daisy chained” via A & B to each indoor unit within the group, (Maximum of 8 units).

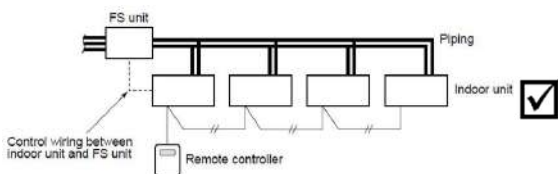

Fig 11

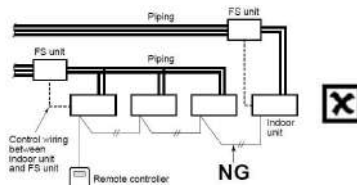

Fig 12

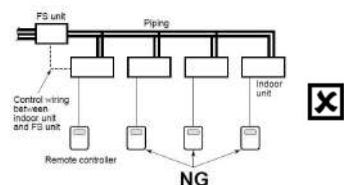

Fig 13

Figures 11, 12 & 13 are some examples, fig 11 is correct, fig 12 & 13 are incorrect.



Cool Designs Ltd

Raising the Standards in Air Conditioning Distribution

Configuring the system.

In order for the system to recognise that multiple indoor units are operating from one flow selector box, the system will need configuring. This is carried out via a standard remote controller, type RBC-AMT32/AMS41 or AMS51/54, configuration cannot be carried out via, infra-red remote controllers, RBC-AS21/41 simplified remote or central remote controllers.

The sequence is the same for AMT32/AMS41 remotes.

How to set up Item code

- 1 Push + buttons simultaneously for 4 seconds or more.
 - ALL is displayed in the UNIT No. window.
 - In this time, the fans of all the indoor units in the group control start the fan operation.
- 2 Using the set temperature buttons / , select the Item code "0E".
- 3 Change SET DATA to "01" by the timer buttons / .
- 4 Push .
- 5 Push . Then the setup finished.

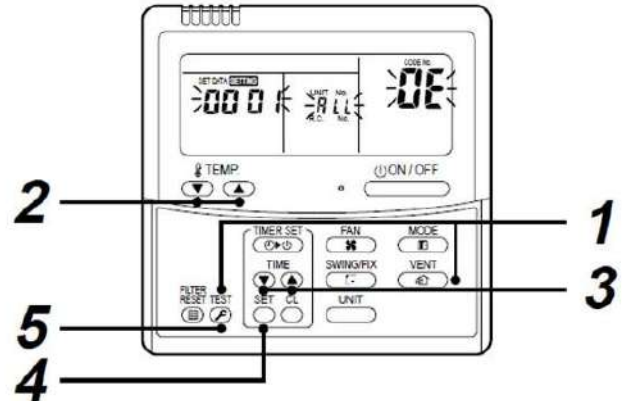

The sequence for the RBC-AMS51/54 remote is slightly different, but carries out the same function.

- 1) Press the " MENU" button to display the "Menu screen"
- 2) Press and hold the " MENU" button and the "
 button at the same time for more than 4 seconds to display the "Field setting menu"
- 3) Scroll down to item "5" using the button.
- 4) Press "F2" Code (DN) 10 will be highlighted on the left of the display.

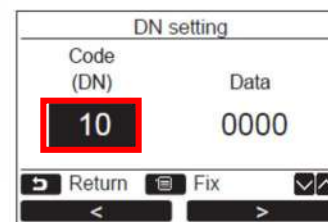
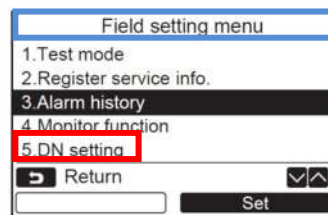
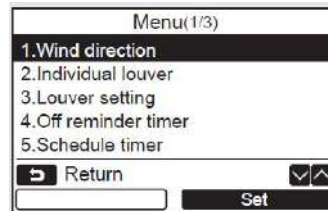

- 5) Scroll the Code (DN) to "OE" using the "[↑↑]/[↓↓]" buttons.
- 6) When Code (DN) "OE" is highlighted on the left press " [F2] " to highlight "Data" on the right.
- 7) Change "Data" from "0000" to "0001" by pressing the "[↑↑]/[↓↓]"
- 8) Press " [Menu] " follow on screen instructions.

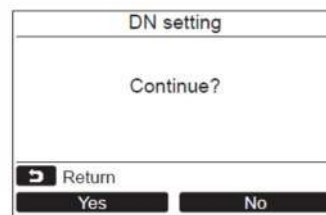
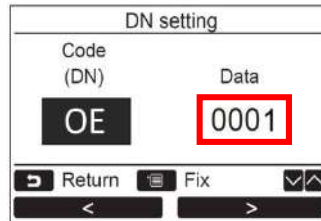

Note:

If the system is to be controlled by local remote controllers ONLY, a remote controller MUST be electrically connected to the indoor unit or "Lead Unit" of a group at ALL times.

If a central controller or BMS interface is connected then local remote controllers DO NOT need to be permanently connected.



Cool Designs Ltd

Raising the Standards in Air Conditioning Distribution

Option 2. - RBM-Y###4FE, (4 Series), Maximum pipe separation between flow selector box and individual indoor units = 50 metres, multiple indoor units maximum accumulated pipe length = 50m
 Power supply to flow selector box via indoor ring main or radial electrical circuit, suggested fuse size of 10 amps. Interconnecting cables between indoor unit and flow selector box, 2 core non-polarity 0.5mm / 2.5mm cable connected A & B.

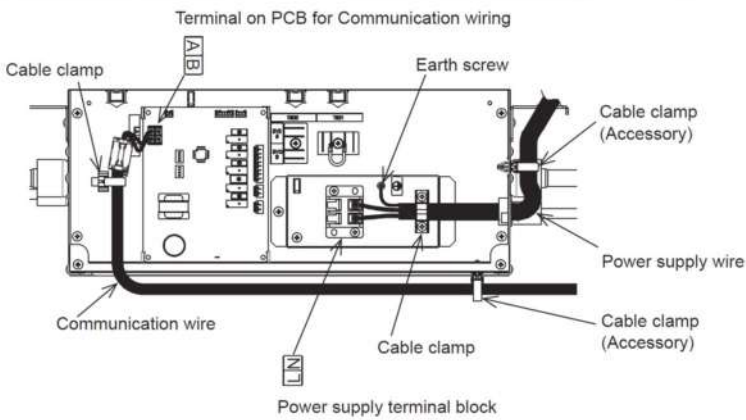

Fig 14

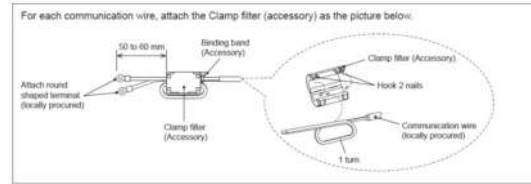

Fig 15

CAUTION

The communication wiring and AC 220-240 V wires cannot be parallel to contact each other and cannot be stored in the same conduits. If doing so, a trouble may be caused on the control system due to noise or other factor.

4 Series flow selector boxes and **multi-port** flow selector boxes require a condensate drain pipe connecting, each flow selector box is supplied with a drain connection and associated ancillary components to facilitate correct connection of the drain pipe.

DO NOT APPLY ADHESIVE to the hard socket drain pipe connection, It is recommended that the components supplied are utilised to prevent premature failure.

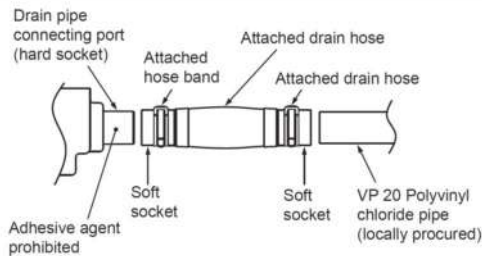

Fig 16

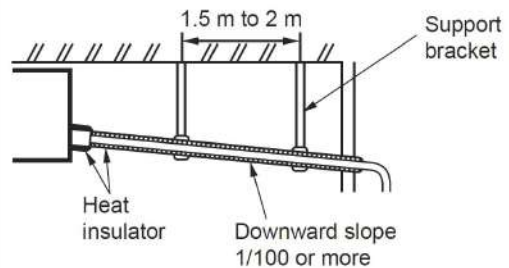

Fig 17

Cool Designs Ltd

Raising the Standards in Air Conditioning Distribution



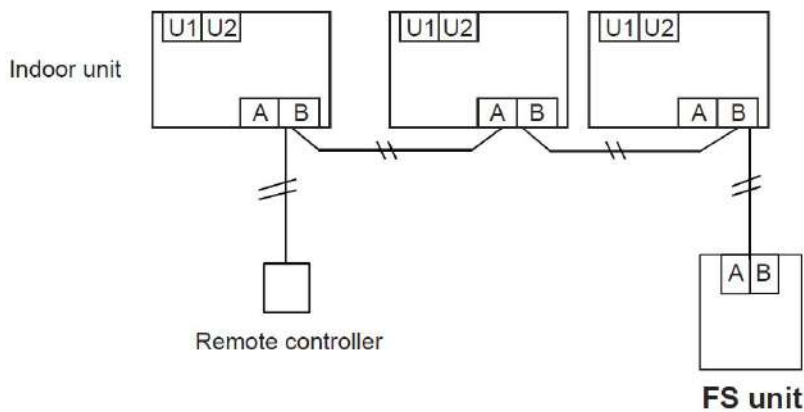

Fig 18

On multiple indoor units to a single 4 series flow selector box, it is possible to individual control the indoor units, please note, when multiple indoor units are connected to a single flow selector box the units operate on the same principle as a two pipe VRF system, default setting is heating, operated by any one of the indoor units, any indoor units not requiring available mode are placed into fan only mode, this can be modified to default cooling via the DN code FD, set data 0000 is default heating, changing the set data to 0001 makes the default mode cooling. The new 4 series flow selector boxes allows for independent or group control of the connected indoor units,

NOTE: This is not possible with the 3 series flow selector boxes.



Cool Designs Ltd

Raising the Standards in Air Conditioning Distribution

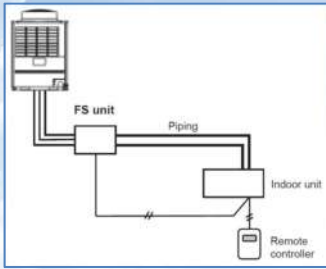

Fig 19

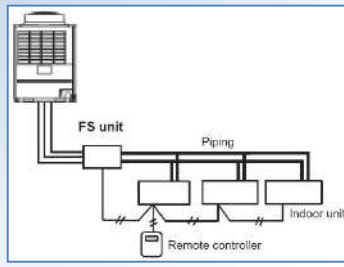

Fig 20

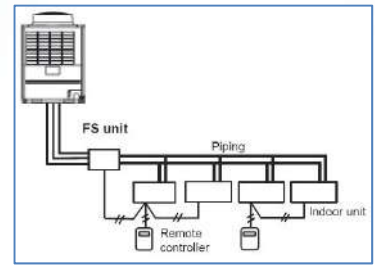

Fig 21

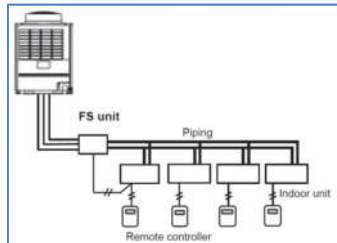

Fig 22

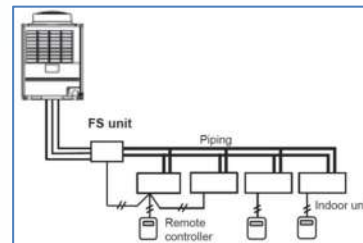

Fig 23

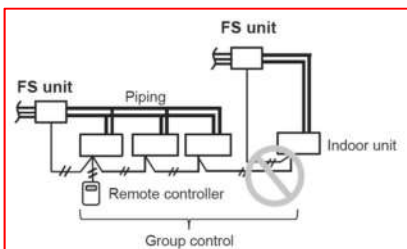

Fig 24

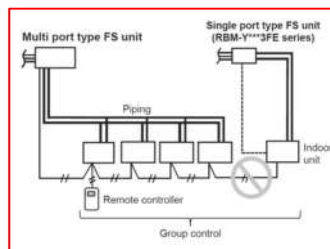

Fig 25

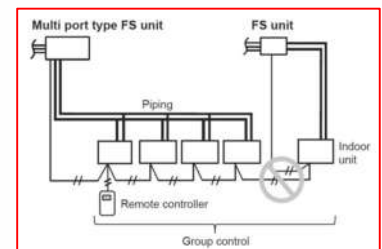

Fig 26

The examples above are a selection of what is **(Blue Frame)** or is not **(Red Frame)** acceptable.

To facilitate multiple indoors on one 4 series flow selector box, each set of units require configuration via the DN codes, please follow earlier instructions to enter the "Field Setting Mode" via a local remote controller, DN codes OE, 14, FE and FD require setting as per the following tables.

The default (Factory) settings for the above DN codes are;

OE - Group Setting - 0 = Individual (Factory). 1 = Group.

14 - Group Address Setting - 0 = Individual (Factory). 1 = Header. 2 = Follower.

FE - Branching System Address (1 - 64) - Should not be duplicated in one system. Factory default = 99

FD - Priority Operation Mode - 0 = Heating (Factory). 1 = Cooling

Fig 19					
	I/D Units				
DN	1	2	3	4	
OE	0				
14	0				
FE	99				
FD	0				

Fig 20					
	I/D Units				
DN	1	2	3	4	
OE	1	1	1		
14	2	2	2		
FE	99	99	99		
FD	0	0	0		

Fig 21					
	I/D Units				
DN	1	2	3	4	
OE	1	1	1	1	
14	1	2	1	2	
FE	1	1	1	1	
FD	0	0	0	0	

Fig 22					
	I/D Units				
DN	1	2	3	4	
OE	1	1	0	0	
14	1	2	0	0	
FE	1	1	1	1	
FD	0	0	0	0	

Fig 23					
	I/D Units				
DN	1	2	3	4	
OE	0	0	0	0	
14	0	0	0	0	
FE	1	1	1	1	
FD	0	0	0	0	

Cool Designs Ltd

Raising the Standards in Air Conditioning Distribution



Option 3. – Multi Port Flow Selector Units, two versions **RBM-Y1801F4PE** - 4 way and **RBM-Y1801F6PE4** - 6 Way. Maximum pipe separation between flow selector box and individual indoor circuits = 50 metres, multiple indoor units maximum accumulated pipe length, 4 way box = 120m, 6 way box = 180m. Power supply to flow selector box via indoor ring main or radial electrical circuit, suggested fuse size of 10 amps. Interconnecting cables between indoor unit and flow selector box, 2 core non-polarity 0.5mm / 2.5mm cable connected A & B.

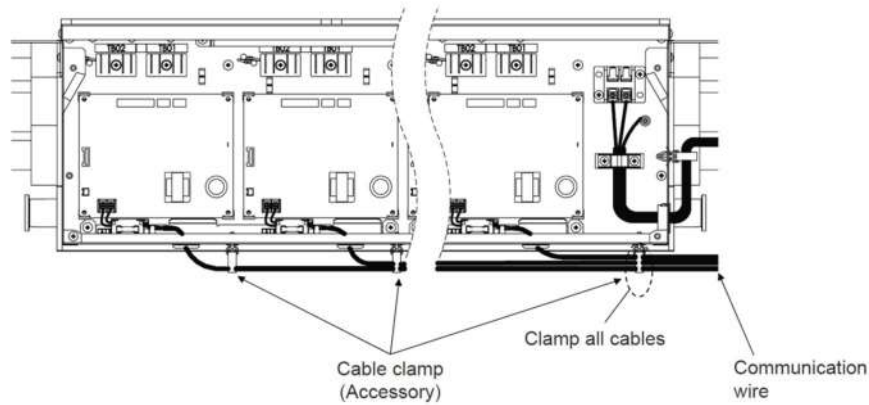

Fig 27

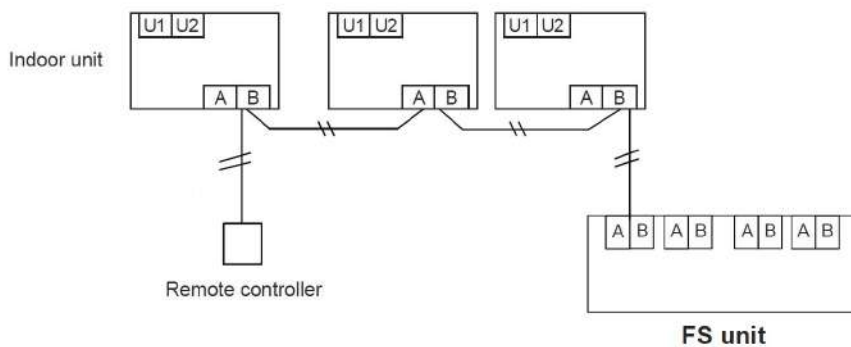

Fig 28

Each multi-port flow selector circuit can have individual indoor units connected, 4 or 6 indoors, (Full independent mode and control) or multiple indoors per circuit, (On multiple indoor units to a single circuit, it is possible to individual control the indoor units, please note, when multiple indoor units are connected to a single circuit the units operate on the same principle as a two pipe VRF system, default setting is heating, operated by any one of the indoor units on the same circuit, any indoor units, on the same circuit, not requiring available mode are placed into fan only mode, this can be modified to default cooling via the DN code FD, set data 0000 is default heating, changing the set data to 0001 makes the default mode cooling. The new multi-port flow selector boxes allows for independent or group control of the connected indoor units per circuit.



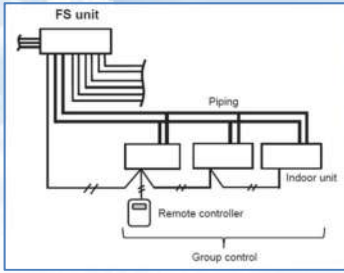

Fig 29

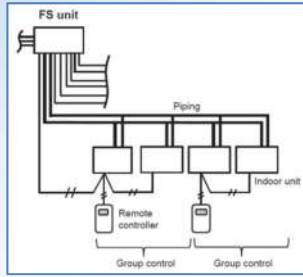

Fig 30

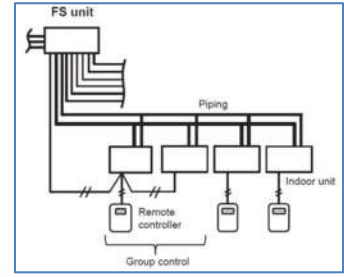

Fig 31

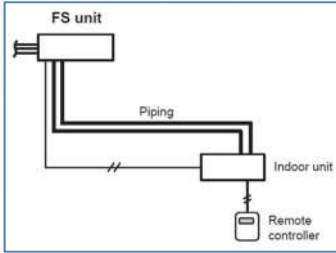

Fig 32

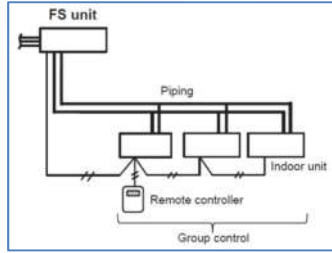

Fig 33

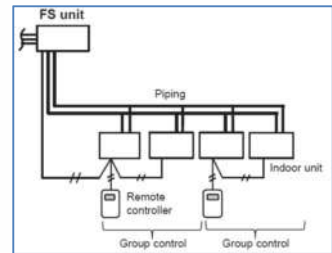

Fig 34

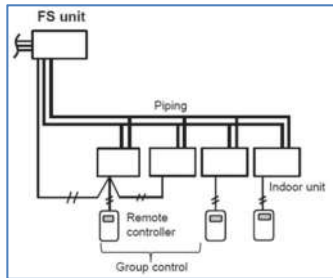

Fig 35

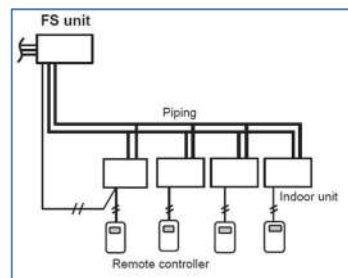

Fig 36

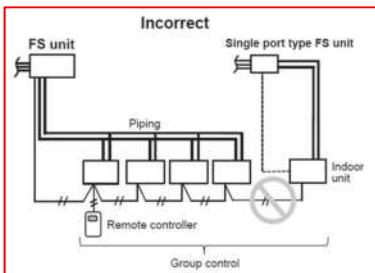

Fig 37

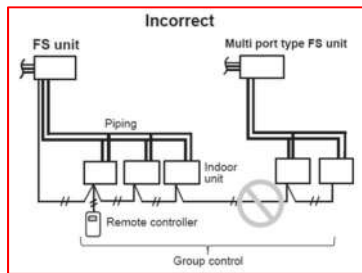

Fig 38

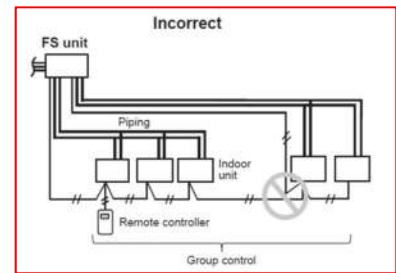

Fig 39

The examples above are a selection of what is **(Blue Frame)** or is not **(Red Frame)** acceptable.

The default (Factory) settings for the above DN codes are;

OE - Group Setting – 0 = Individual (Factory). 1 = Group.

FE – Branching System Address (1 – 64) – Should not be duplicated in one system. Factory default = 99

FD – Priority Operation Mode – 0 = Heating (Factory). 1 = Cooling

Fig 29				
	I/D Units			
DN	1	2	3	4
OE	1	1	1	1
FE	99	99	99	
FD	0	0	0	

Fig 30				
	I/D Units			
DN	1	2	3	4
OE	1	1	1	1
FE	1	1	1	1
FD	0	0	0	0

Fig 31				
	I/D Units			
DN	1	2	3	4
OE	1	1	0	0
FE	1	1	1	1
FD	0	0	0	0

Fig 32				
	I/D Units			
DN	1	2	3	4
OE	0			
FE	99			
FD	0			

Fig 33				
	I/D Units			
DN	1	2	3	4
OE	1	1	1	1
FE	99	99	99	
FD	0	0	0	

Fig 34				
	I/D Units			
DN	1	2	3	4
OE	1	1	1	1
FE	1	1	1	1
FD	0	0	0	0

Fig 35				
	I/D Units			
DN	1	2	3	4
OE	1	1	0	0
FE	1	1	1	1
FD	0	0	0	0

Fig 36				
	I/D Units			
DN	1	2	3	4
OE	0	0	0	0
FE	1	1	1	1
FD	0	0	0	0

Auxiliary Condensate Pump (Field Supplied)

If an auxiliary condensate pump is fitted 230 volts' power supply can be obtained via terminals L & N, fig 40, it is recommended that a 1 amp in-line fuse, fig41 is wired into the circuit.

Auxiliary float switch connections are available via the CN34 socket, fig 42 located on each circuit's printed circuit board, within the multi-port flow selector, fig43.

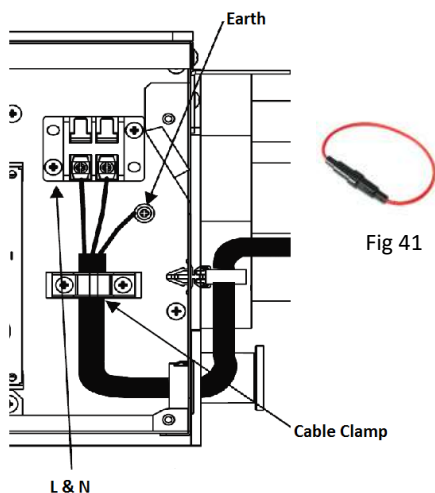

Fig 40

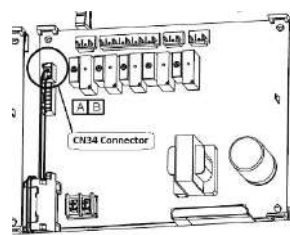

Fig 42

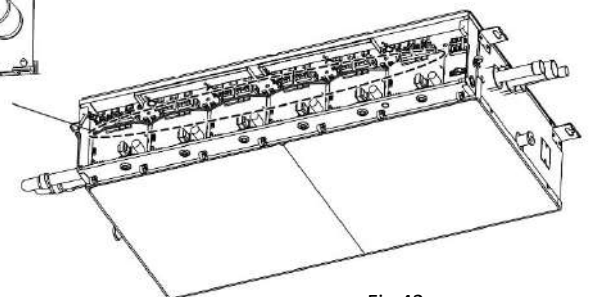

Fig 43



“Wave Tool.”

SHRMe outdoor units are equipped with the next generation of service and commissioning tools utilising an Android Smartphone equipped with “NFC” (Near Field Contact), an “NFC” tag is fitted to each outdoor “e Series” unit and is located on the outdoor unit top front above the electrical control panel, fig37.

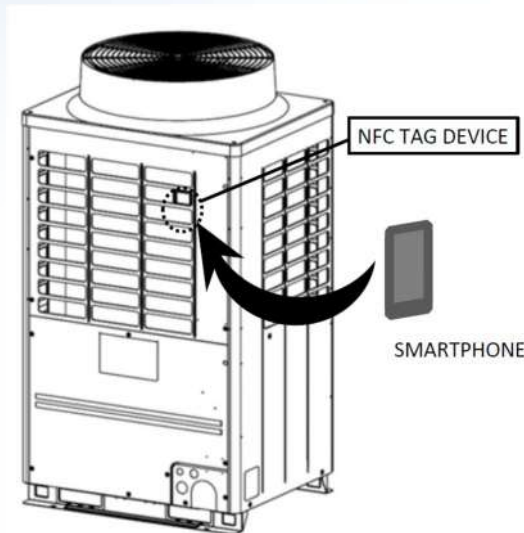

Fig 37

You will require a suitable Android Smartphone running Android version 5 or better and the “SMMS Wave” app, which can be downloaded from the web site listed below;



URL : http://www.toshiba-carrier.co.jp/global/appli/smms_wave_tool/

Please make sure to read the instructions available on the above web site.

Cool Designs Ltd

Raising the Standards in Air Conditioning Distribution



Contact details:

Cool Designs Ltd Technical Support

07590 775510 / 07706 293028

Monday – Friday 07.30 to 19.30

Email: support@cooldesignsltd.co.uk

Web site: www.cdlweb.info



Toshiba Air Conditioning

24/7 technical support

0870 843 0333 (Option 7)

Text back service

07624 803 017

(Type fault code in lower case no spaces)



[Try our on-line training videos on YouTube.](#)

Cool Designs Ltd reserves the right to change the product specifications, data and images without notice



Cool Designs Ltd

Raising the Standards in Air Conditioning Distribution