

Toshiba Air Conditioning - RAV-SM Data Sheet

RAV-SM404ATP-E Outdoor Unit

Features

- R22 and R407C replacement technology
- Wide operating range (cooling mode -15°C to +46°C)
- Auto-diagnostic function
- Flexible, can be utilised for single, twin, triple indoor applications
- Compact size



Technical Data

Model reference		RAV-SM404ATP-E
Nominal cooling	kW	3.6
Nominal heating	kW	4.0
Standard air flow	m ³ /h	1850
Standard air flow	l/s	514
Sound power (cool/heat)	dB(A)	64/65
Sound pressure (cool/heat)	dB(A)	49/50
Dimensions (H x W x D)	mm	550 x 780 x 290
Unit weight	kg	39
Power supply	V-ph-Hz	220/240-1-50/60
Interconnecting cable		3 core + earth
Suggested fuse size	A	16
Maximum operating current (cooling)	A	10.0
Operating range, cooling	°C	-15 to 46
Operating range, heating	°C	-15 to 24
Pipe sizes (liquid-suction)	inch	1/4-1/2
Minimum/maximum pipe length	m	2/20
Maximum height difference	m	10
Pre-charge pipe length	m	15
Additional R410A refrigerant - factory charge	g/m - kg	20 - 1.4

Dimensional Drawings

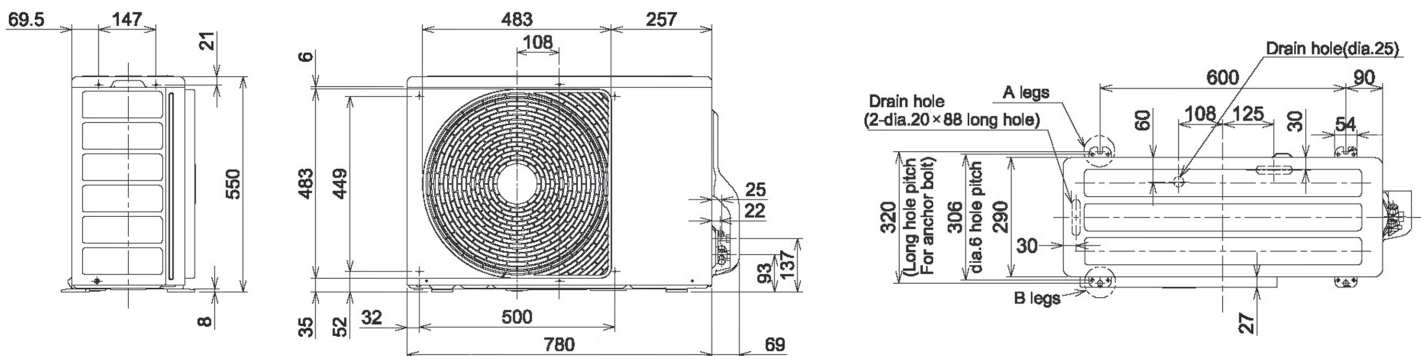

Cool Designs Ltd

Raising the Standards in Air Conditioning Distribution

www.cdlweb.info

