

Toshiba Air Conditioning - VRF Data Sheet

MMU-AP0182WH 2-way cassette

Features

- Compact dimensions (height 345 mm - 4.5 to 16 kW)
- Unique air flow control
- Auxiliary fresh air intake
- Lift pump up to 425 mm lift
- Long life filters



Technical Data

Model reference		MMU-AP0182WH
Nominal cooling	kW	5.6
Nominal heating	kW	6.3
Capacity code		2.0
Power input (cool/heat)	kW	0.044
UK cooling	kW	5.38
UK sensible cooling	kW	4.04
UK heating	kW	5.1
Starting current	A	0.48
Running current	A	0.32
Suggested fuse size	A	5
Power supply	V-ph-Hz	220/240-1-50
Interconnecting cable		2-core screened 1.5 mm
Sound power H-M-L	dB(A)	50-48-45
Sound pressure H-L	dB(A)	35-30
Air flow H-L	m ³ /h	900-618
Air flow H-L	l/s	250-172
Dimensions (H x W x D)	mm	345 x 1180 x 570
Unit weight	kg	26
Panel reference		RBC-UW803PG(W)-E
Panel dimensions (H x W x D)	mm	20 x 1415 x 680

Dimensional Drawings

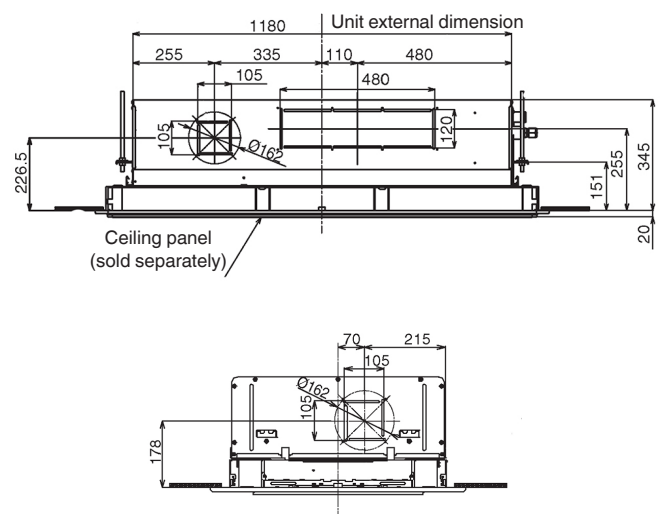
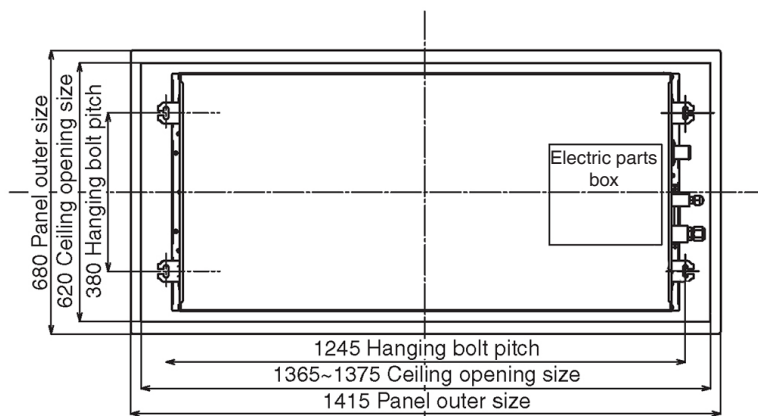

Cool Designs Ltd

Raising the Standards in Air Conditioning Distribution

www.cdlweb.info

